

SCIENTIFIC AMERICAN

[Entered at the Post Office of New York, N. Y., as Second Class Matter. Copyright, 1908, by Munn & Co.]

Vol. XCIX.—No. 15.
ESTABLISHED 1845.

NEW YORK, OCTOBER 10, 1908.

[10 CENTS A COPY
\$3.00 A YEAR.]

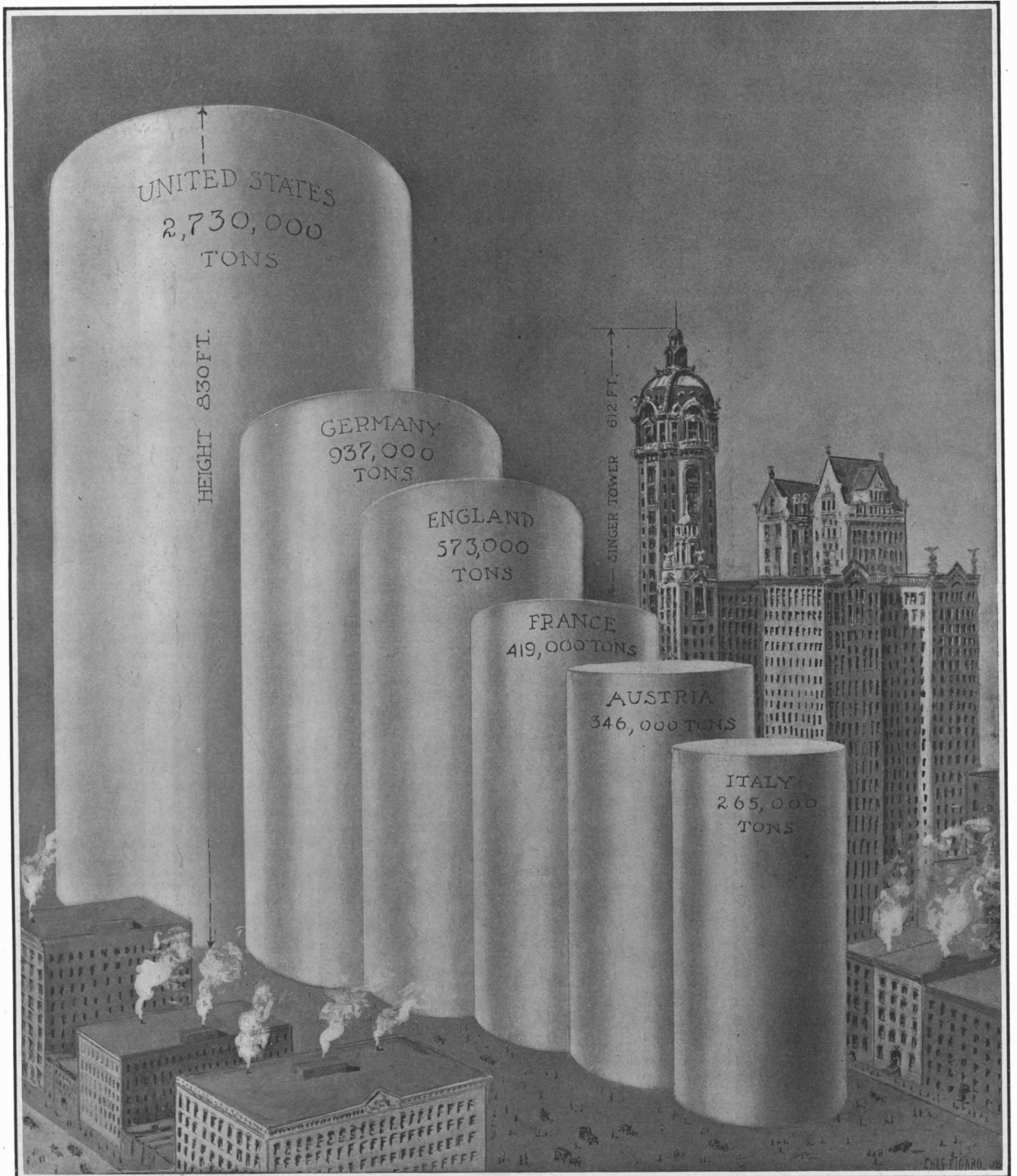

Copyright 1908 by Munn & Co. All rights reserved.

Entire Forests are Transformed Little by Little into Paper for Newspapers and Books. Less than 3 Per Cent of the Wood cut, however, is Consumed in this Industry.

THE CIVILIZED WORLD'S CONSUMPTION OF PAPER PRESENTED IN GRAPHICAL FORM.—[See page 248.]

SCIENTIFIC AMERICAN

ESTABLISHED 1845

MUNN & CO. - Editors and Proprietors

Published Weekly at

No. 361 Broadway, New York

CHARLES ALLEN MUNN, *President*

361 Broadway, New York

FREDERICK CONVERSE BEACH, *Sec'y and Treas.*

361 Broadway, New York

TERMS TO SUBSCRIBERS.

One copy, one year, for the United States or Mexico \$3.00
 One copy, one year, for Canada 3.75
 One copy, one year, to any foreign country, postage prepaid, 18s. 6d. 4.50

THE SCIENTIFIC AMERICAN PUBLICATIONS:

Scientific American (established 1845).....\$3.00 a year
 Scientific American Supplement (established 1876)..... 5.00 "
 American Homes and Gardens 3.00 "
 Scientific American Export Edition (established 1878). 3.00 "

The combined subscription rates and rates to foreign countries, including Canada, will be furnished upon application.

Remit by postal or express money order, or by bank draft or check.

MUNN & CO., 361 Broadway, New York.

NEW YORK, SATURDAY, OCTOBER 10, 1908.

The Editor is always glad to receive for examination illustrated articles on subjects of timely interest. If the photographs are sharp, the articles short, and the facts authentic, the contributions will receive special attention. Accepted articles will be paid for at regular space rates.

ENCOURAGING DECREASE OF IDLE CARS.

There is no surer test of the prosperity of the country than the number of idle cars on its railroads; and any reduction in the total may be taken as a sure indication that the wheels of industry are turning more rapidly. Consequently, the recent report of the Committee on Car Efficiency of the American Railway Association, which tells of a decrease of over fifty thousand in the number of idle cars in two weeks of September, is the most encouraging sign of returning prosperity that has been given for many months. At the close of April the maximum number of idle cars was 413,338; but this number, according to the report referred to, has gradually been reduced to 170,652. Now that the crisis is well passed, the fact has been made public that the total number of idle cars, as given out to the public, did not include freight cars which were in the shops for repairs. A prominent official recently stated that, if these cars had been added to the total shown by the committee's reports, the number of idle cars would have been nearly six hundred thousand.

POSTAL TUBES IN THE SUBWAYS.

Ever since the completion of the Subway in this city, it has been a matter of regret that galleries were not constructed at the sides of the tunnels, for the accommodation of gas and water pipes, and the electric power and lighting cables. All future subways will be provided with these galleries, and on the streets and thoroughfares beneath which they are located, the intolerable confusion at present occasioned by the laying or relaying of city mains will be avoided.

The importance of the pipe galleries is brought forcibly to mind by the recent action of the Post Office Department in Washington, in addressing the Public Service Commission in this city, to ascertain if it will be possible to install pneumatic tubes in any new subways that may be built, as well as in existing subways and those that are now under construction. The Postmaster-General has contracted with the New York Pneumatic Service Company for the installation of pneumatic tubes for rapid mail delivery, and the present application is an outcome of that arrangement.

THE ENORMOUS LOSS BY FOREST FIRES.

If anything can awaken the people of this country to the necessity for organizing effective systems of fire protection, it is the enormous losses which have occurred during the past few weeks through forest fires. The month of September was not two weeks old before the national forest officials in Washington estimated that the value, in money, of the standing timber that had been destroyed, up to that time, was sufficient to rebuild the greater part of the United States navy. Since that statement was made, the fires increased in area, and many fresh outbreaks occurred in districts as yet unvisited. The ravages of fire this autumn have been almost continuous throughout the various timber belts, from the Pacific coast to the New England States. The events of the past few weeks have demonstrated that, although the work done by the forest officials has been generally commendable, the force is absurdly inadequate to cope with the perilous conditions produced by a long period of drought. The organization of a sufficient fire patrol to adequately protect our forests would involve an annual cost that would represent but a small rate of insurance on a priceless national asset, which, under existing conditions, is exposed every season to unpreventable destruction.

THE SCHENECTADY CAR FENDER TESTS.

The results obtained in the tests of car fenders, which are being carried on at Schenectady for the Public Service Commission of this city, are encouraging, and give reason to believe that, as the outcome of this movement, a fender will be developed which is capable of lifting a person from the track and carrying him along without any serious injury. At present, however, the ideal device has not been found, although several of the inventions offered for test have shown more or less of the requirements of the perfect fender. Taken as a whole, the inventions display an intelligent appreciation of the problems involved and great mechanical ingenuity in meeting them. This was particularly noticeable in the case of a fender of the wheel-guard type, which, immediately on contact, dropped to the track, picked up the body, shut off the power, opened the sand box, and set the air brake; the car, although running at a speed of fifteen miles an hour, being brought to a stop in not much more than its own length. The type of fenders which drop to the track on striking a body, some of which were released automatically, and others by the action of the motorman, were successful, as a rule, in picking up standing dummies. But when the figures were prostrate, they were not always so successful. This was the case when the dummies lay on the track with the feet pointing toward the car, especially if they were laid near one of the rails; in which case the fender would climb over the body and allow it to come in contact with the trucks. The widespread interest which has been aroused by these tests is shown by the fact that they are attended not only by representatives of nearly all the street railway companies in New York, but by engineers and railroad men from all parts of the country, and by representatives of the United States army and navy. Already, over a score of fenders have been offered for the second series of tests which will commence on October 20 at Pittsburg.

A FOUR-TRACK FREIGHT TUNNEL FOR MANHATTAN ISLAND.

The offer of a powerful corporation in this city to build a four-track electric freight subway around the water front of Manhattan Island, with tunnel connections to New Jersey, seems to us to be the best solution of the freight problem which has yet been proposed. The scheme represents the results of several years study by W. J. Wilgus, formerly Chief Engineer of the New York Central Railroad, and now president of the company which proposes to undertake this gigantic work. The plan has been submitted to the Public Service Commission, and is made public with a view to securing public discussion of its merits. The subway would commence at 60th Street and the Hudson River and extend around the water front to the Bronx. There would be a large terminal for New York Central freight at 60th Street. It would extend below West Street on the Hudson River side, and near the southerly end of Manhattan connection would be made by tunnel with a large terminal on the Jersey side, where the freight from the Pennsylvania, Jersey Central, Erie, Lehigh, Lackawanna, and West Shore roads would be assembled and distributed. At some suitable point below Forty-second Street, a crosstown line would be built to a junction with the line extending along the East River water front, which would be carried north to terminate in the large freight yards of the New Haven Railroad Company in the Bronx.

As feeders to the main belt line, spurs would be built under the sidewalks and adjoining the basements, in those districts to which large amounts of freight are shipped. Small cars, carrying about 10 tons, would be used on these side lines, and they would deliver their freight direct into the basements of the business houses thus served. One immediate advantage of the system would be the elimination of the dangerous freight tracks of the New York Central Railroad, which at present run down the west side of Manhattan Island. The scheme also includes the ultimate construction of an overhead road to provide for passenger traffic, and give direct connection to and from the steamship piers of the various companies.

Outside of the great convenience afforded by the proposed freight line in putting the business centers of the city in direct rail communication with the various industrial centers throughout the country, there are other collateral advantages of considerable importance. Thus, the streets of the city would be rid of a large amount of vehicular traffic of the kind that is most destructive to the surface of the streets and most obstructive of the free movement of traffic on the street railways. The substitution of tunnels for light-erage would rid the harbor of a vast amount of traffic which is at present one of the most serious hindrances to river navigation. The various docks and piers would be relieved of their present railroad traffic, and would be released for occupation by traffic that is water-borne. The company that proposes this gigantic improvement estimates that because of the many benefits conferred, there would be net savings and

profits to shippers, carriers, investors, and the public of a sum in excess of \$15,000,000 per annum.

NASMYTH—THE CENTENARY OF A GREAT INVENTOR.

A recapitulation of the principal inventions of that truly great engineer Nasmyth, the centenary of whose birth occurred on the 19th of August of the present year, will be surprising to many of our readers, both because of the number, variety, and importance of these inventions, and the fact that they were made so long ago. Although he is celebrated chiefly as being the originator of the steam hammer, it is a fact that many of the most important mechanical devices of the present day owe their genesis to his fertile brain, as the following digest from an enumeration of his inventions, given by our esteemed contemporary, The Engineer of London, will show:

Nasmyth's first invention, brought out in 1825, was for "a mode of applying steam power for the traction of canal barges without injury to the canal banks." It consisted of a chain laid along the bottom of the canal, which passed between three pulleys or rollers driven by a steam engine placed in a tug-boat to which a train of barges was coupled. Two years later, he devised "a method of increasing the effectiveness of steam and superheating it on its passage from the boiler to the engine." This is claimed to have been the first introduction of superheated steam. In the following year he devised a method of "chucking" delicate metal work, which consisted of tinning the work down on a tinned faceplate which had been heated sufficiently to cause the solder to flow, the work being melted off the chuck after it was completed. In the following year he anticipated a familiar modern method of transmitting motion, when he took out a patent for "a mode of transmitting rotary motion by means of a flexible shaft formed of a coiled spiral wire or rod of steel."

How prolific was this inventor is shown by an enumeration of his patents taken out in the year 1836 alone. They included a "machine for cutting key grooves in metal wheels and belt pulleys"; a device for "finding and marking the centers of cylindrical rods or bolts about to be turned on the lathe"; "an improved form of packingless steam engine piston," and "a machine for planing the smaller or detailed parts of machinery, whether flat or cylindrical."

To Nasmyth is due the "method of reversing the action of slide lathes," which consists of a pair of meshing spur gears carried on a hand lever fulcrumed on the back of the fixed headstock, which he patented in 1837; and in the following year he brought out "a self-adjusting bearing for the shafting of machinery," which consisted in giving a spherical form to the exterior of the bearing. In this year also he brought out that important device, the "safety foundry ladle," which has since proved of such value to foundrymen. Because of its humanitarian qualities in the prevention of death or injury, this idea was given to the public without any protection by letters patent.

In 1839 he invented the well-known wedge-shaped sluice valve for water pipes; and it was in this year that he won his greatest fame by the invention of the steam hammer. The motive for this came from the Great Western Railway Company, who wished for some means of forging a huge wrought-iron paddle shaft; and in his autobiography, in speaking of this invention, Nasmyth writes: "In little more than half an hour . . . I had the whole contrivance in all of its executant details before me in a page of my scheme book." This design consisted of a block of iron for the hammer to which a piston rod was attached, an anvil, and an inverted steam cylinder. The hammer was lifted by admitting steam, under the control of a hand-operated slide valve, below the piston, and it fell by gravity. The automatic trip-valve gear, invented by Robert Wilson, was subsequently applied, and, finally, Nasmyth improved his hammer by making it double-acting, and utilizing steam to assist gravity on the downstroke. In the same year, not satisfied with his work on the steam hammer, Nasmyth turned to hydraulic power, and invented the "hydraulic mattress press," a square or circular water-tight vessel with semicircular flexible metal sides.

In 1843 he invented the steam pile-driver, and his first machine drove a 70-foot pile in 4½ minutes, in a contest against a hand-operated pile driver, which took just twelve hours to do the same work. He later invented suction fans for the ventilation of coal mines; an improved method of welding; a spherical-seated direct-weighted safety valve; a machine for cutting out slots by a traversing drill; an inverted vertical steam engine; and in 1848 he devised a hydraulic punching machine. When we remember that the above is but a partial list of his inventions, we can understand with what satisfaction he retired at the early age of forty-eight from active business, "to enjoy," as he wrote in a brief record of his career, "the rest of my life in the active pursuit of my most favored occupations," chief among which was the science of astronomy.

ENGINEERING.

The vast scale of operations at Panama is shown by the fact that during the fiscal year ended June 30, the value of material received by the Division of Materials and Supplies was over eleven and a half million dollars; and the value of material disbursed exceeded that sum by seventy-eight thousand dollars.

It is reported that the mammoth vessel "Olympic," to be built for the White Star Line, will be of 50,000 tons displacement and 840 feet long. We accept the displacement, but seriously doubt the length. The ship would overlap our longest New York piers by 40 feet. The extra 5,000 tons over the 45,000 tons of the "Lusitania" could easily be obtained by a greater fullness in the lines.

The accident report of the Public Service Commission of New York State for last year shows that out of 104,113,466 passengers carried by the steam railroads, 24.2 were killed in each million carried, and 246.2 were injured. The electric railroads carried 416,279,788 passengers, the ratio of killed to each million being 5.98, and of injured 104.9. The high rate of injuries and fatalities on steam railroads was due to the disastrous wrecks at Woodlawn and Lansingburg.

It is a curious anomaly that the most powerful "Dreadnought" afloat should belong to a South American republic; but it cannot be denied that the "Minas Geraes" is entitled to this distinction. She is the only warship mounting twelve 12-inch guns; and they are so placed that she can concentrate eight ahead and astern and ten on either broadside, as against four ahead and astern and ten on either broadside, which can be done by our new "North Dakota" and "Delaware."

The most serious fact developed by the cruise of the Pacific fleet was our shortage of colliers. It was all very well to carry coal in foreign bottoms during a peaceful maneuver; in time of war these ships would not be available. Hence there is some satisfaction to be derived from the recent awarding to the Maryland Steel Company of the contract for three large colliers. Congress should appropriate for others, until we have a fleet sufficient for the greatest possible needs of the navy.

According to cable dispatches, the French people are urging Wilbur Wright to make a flight across the English Channel. As to his ability to do this, there can be little doubt; as to the expediency of doing it, there is no doubt whatever; for it would be the most foolish thing that he could attempt at the present time. A slight mishap to the motor would mean a descent into the sea and a probable catastrophe. The work already done by Wright should prove sufficiently spectacular to satisfy even the excitement-loving people of France.

The neglect to provide approaches, and connect the various surface and elevated roads with the great bridges across the East River, New York, has been one of the scandals of city administration. Recently, the existing connections with the Brooklyn Bridge have been improved by the construction of inclines and the widening of the roadways. The Williamsburg Bridge, also, is coming into its own; for at last the elevated structure, built into the bridge at the time of its opening, has been connected with a subway terminal on Manhattan, and with the existing elevated lines in Brooklyn. Nothing, however, has been done in the way of connections for the great Blackwell's Island cantilever structure.

The British Home Office recently published a report of the Inspector of Mines on the fatal colliery accident at Durham. The explosion was caused by firing a shot of "permitted explosives," bellite No. 1. The conditions were not abnormal, but were such as often arise in dry and dusty collieries. The shot was fired "without watering," which is a violation of the Coal Mines Regulation Act. It seems that the locality of a blast is not usually watered when permitted explosives are used, on the ground that the latter are not of such a nature as would inflame gas or dust. But the fact that within sixteen months four explosions have occurred under these conditions proves that precautions are as necessary as when gunpowder was the explosive.

The marvel of to-day becomes the matter of fact of to-morrow. It does not seem to some of us so very long ago since we wondered at the audacious flights of imagination of Jules Verne, when he pictured a trip around the world in eighty days. Yet it is a fact that the passenger may now take forty days' vacation, and accomplish the Jules Verne feat with plenty of stopping time on the route. The statistics of this trip come from London, and the compiler of them asks merely that the Cunard steamships shall make their call at an English Channel port. He figures out the run as follows: Leave New York Saturday by the "Lusitania"; land at Plymouth the following Thursday, reaching London in time to catch the evening train for Berlin. Leaving Berlin Friday evening, the traveler reaches Moscow Sunday morning. He would be at Vladivostok, on the Pacific, the following Thursday week; and, leaving there on the next Saturday evening, would be landed at Tsuruga, Japan, on the Monday following. Taking train across to Yokohama, he would catch the Canadian Pacific steamer, sailing the same day, and reach Vancouver twelve days later. Then taking the Great Northern Limited to St. Paul, the Northwest Limited to Chicago, and the Twentieth Century Limited for New York, he would reach his starting point at 9:30 on Thursday morning, having taken less than forty days for this 20,000-mile journey.

ELECTRICITY.

The Victorian State Railway, Australia, has been studying the electrified steam railways of England with a view to adopting electric traction on the Melbourne suburban railways. It is proposed to electrify 40 miles of track.

Electricity is slowly but surely making its way into the household. The latest is the electrical fireless cooker. The cooker is provided with steatite radiators that are electrically heated, and the food is then slowly cooked by the stored heat. In this connection electricity can compete with gas, coal, or oil because practically all the heat generated by the current is absorbed by the radiator.

The Electrical Engineer of London describes an interesting interpole motor adapted particularly for tramway systems or for use in any circumstances where the duty is more than ordinarily heavy. In order to provide an especially good ventilation of the armature, the connections between the armature coils and the commutator bars are made of flat copper strips, which act as fan vanes to draw a current of air through the motor when the armature rotates. It is claimed that this artificially-produced draft cools the motor fully 25 per cent.

To handle the telephone business of the twin Hudson Terminal buildings, 750 miles of telephone wire are necessary. When the Metropolitan Life building is completed, it will have in its installation 680 miles of telephone wire. The City Investment building is provided with 450 miles of telephone wire, while the Broad Exchange and the Singer buildings are installed with 250 and 230 miles of wire respectively. In these five buildings alone the telephone wires total a length of 2,360 miles, and would stretch from New York nearly to San Francisco.

The ideal wire for transmission purposes is one which will combine the tensile strength of steel with the non-corrosive qualities and conductivity of copper. Efforts to make a wire of this sort by coating a steel wire with a layer of copper have not been very satisfactory, owing to the impossibility of preventing air from entering between the copper and steel, causing the latter to rust and the former to flake off. A recent invention provides a new process for combining the metals, so that a perfect union between the two is obtained. This consists in applying a heavy coat of copper to a billet of steel while both are heated to a high temperature. The air between the two metals is driven out by the heat, and the copper and steel are virtually welded together. The billet after being cooled is heated again and rolled into a wire $\frac{3}{8}$ of an inch in diameter, and is then drawn down to any size desired. So perfect is the union between the two metals that it is impossible to hammer off a piece of the copper, even when it is notched so as to leave a tongue of copper projecting from the steel.

Some time ago Carl Hering, when investigating the action of conductors in an electric furnace, discovered that after the metal had been reduced to a liquid state, at a certain temperature there is set up in the metal an attraction toward its axis, producing what he called a "pinched" effect. That is, the liquid seems to be reduced at the center, as if it had been pinched by the fingers, while at the ends it is piled up, producing a hydrostatic pressure between the axis and the circumference of the conductor. This peculiar effect has been utilized by Dr. E. F. Northrup in an ammeter for measuring very large alternating currents. Heretofore, we have had no instrument of simple form that would accurately measure any alternating current of over 1,000 amperes. In Dr. Northrup's instrument two mercury cells are used, which are $\frac{1}{64}$ of an inch in length. Over the mercury a quantity of colored oil is placed, and the hydrostatic pressure produced when passing a current through this mercury causes the oil to rise in a glass tube, and the strength of the current is measured by the height to which the oil rises.

Electric apparatus for ozonizing water is now used in three of the German cities, namely, Berlin, Wiesbaden, and Paderborn. These plants serve to purify drinking water. The ozonizer is a modification of the Berthelot apparatus, and consists of a boiler or iron tank which is filled with water and contains three vertical glass tubes. These tubes project below the bottom of the tank through tight joints, and the lower ends are in contact with the air. Each of the tubes contains an aluminium cylinder. The air penetrates into the space between the cylinder and the tube and thus enters the tank at the upper part which is designed to contain the ozonized air. The aluminium forms the positive pole and the tank the negative pole of the current, which has a tension of 8,000 volts. The water in the tank becomes the outer coating of the condenser. An electric discharge takes place between the aluminium and the glass, which is of a silent nature. The iron tanks are connected to the ground by hollow iron columns which serve as supports. Placed together in a dark part of the plant, the boxes are mounted so that the operator can see the discharge through an opening. The air is first dried and filtered, and the water is also filtered. The ozone which is thus formed is led into the sterilizing towers, which are filled with gravel, and the water trickles down through this and comes in contact with the ozone. It is noticed that the ozonized water has a special taste and odor at first, but it loses this when passed in a masonry conduit. From 14 to 27 grammes of ozone per horse-power are obtained. Such water is very pure and almost free from bacteria, as has been determined. What germs may be left are of a harmless character, and cholera or typhoid bacteria are removed.

SCIENCE.

It is said that Ekeberg, the Swedish discoverer of tantalum, gave that name to the metal because of the tantalizing difficulties that he encountered while investigating it. It is only recently that tantalum has been obtained in a state of purity. A single pound of tantalum suffices to furnish 23,000 lamps, each of 25 candle-power.

The Peary Arctic Club has received word that Commander Peary's vessel "Roosevelt" struck an iceberg with serious damage. Commander Peary states that he is proceeding along shore and that the prospects are good, despite the collision. A previous communication stated that Cape York was reached on July 31, that the "Roosevelt" was overhauled and trimmed for the ice at Etah, and that dogs were secured. The season is unusually stormy, with much snow and no ice as yet. Thirty-five walrus were killed, which means that the expedition has much good fresh meat.

Madam Curie's announcement that she has been unable to obtain experimental verification of Sir William Ramsay's discovery of the transmutation of copper to sodium, potassium, and lithium naturally makes one wonder if the late Lord Kelvin was not justified in doubting the accuracy of Sir William's investigation. On the other hand, Ramsay is so careful a chemist that he is not likely to draw rash conclusions. That even the most cautious of chemists may err is proven by Prof. Onnes's first announcement of the liquefaction of helium. Madam Curie carefully purified her materials. So did Ramsay. Yet we have contradictory results. We must wait now for a third verification or refutation before we can be quite sure.

The recent development of aeronautics has given importance to the production of hydrogen, illuminating gas having gone out of fashion as completely as Montgolfier's hot air, and for the same reason—because it is too heavy. In a new American method of producing hydrogen, water gas is first made in the usual way, by passing steam over live coal. The resulting water gas, which is a mixture of hydrogen and carbon monoxide, is then passed over hot pulverized calcium carbide. The carbon monoxide is decomposed, the carbon remaining behind in the form of graphite and the oxygen combining with the carbide to form calcium carbonate, leaving the hydrogen almost pure (97 per cent). It is claimed that hydrogen can be produced very cheaply by this process.

Paper money is popularly supposed to be a carrier of infectious diseases. No doubt microbes do find a resting place on many of the bills now in circulation, but investigations which have been conducted at the research laboratory of the New York Board of Health indicate that although paper money is by no means free from bacteria, it is, nevertheless, not quite so prolific a breeding ground as may be supposed. On clean bank bills an average of 2,350 bacteria were discovered. On soiled bills the average was 73,000. This investigation was made some years ago. Its results have now been checked by Warren W. Hilditch of the Sheffield laboratory of bacteriology and research at Yale. The dirtiest bills which banks and railways could place at his disposal showed an average of only 142,000 bacteria for each bill. The lowest was 14,000; the highest, 586,000. Curiously enough, the cleanest-looking note was charged with 405,000 bacteria, and the dirtiest with 38,000, which seems to prove that there is no necessary connection between dirt and bacteria. Mr. Hilditch finds that guinea pigs inoculated with these bacteria contracted no disease, which would mean that money bacteria are not necessarily virulent.

A large quantity of combined nitrogen is lost in distillery wastes. Methods of recovering this nitrogen in the form of ammonia have been devised, but they have proved impracticable, for the following reasons: By dry distillation only 50 or 60 per cent of the nitrogen can be recovered, and half of this is in the form of amides; the sulphate of ammonia produced is difficult to crystallize and is hygroscopic, and the apparatus required is so expensive that no profit is left after operating, interest, and maintenance charges are met. Effront conceived the idea of treating distillery wastes by biological methods and endeavored to find a diastase by the action of which the nitrogen contained in those wastes could be converted into ammonia under conditions obtainable in practice and with some hope of profit. His researches have led to the following results: 1. Beer yeast contains a diastase, which Effront has named "amidase," and which converts amido-acids completely into ammonia and volatile fatty acids. 2. Amidase is found also in butyric acid ferments and in various species of bacteria and molds. 3. The organic nitrogen contained in distillery wastes derived from grain, beets or molasses, can be converted into ammonia by the action of beer yeast in its "autophagous," or self-consuming phase, or by that of other ferments which have been brought into a special condition by aeration or the addition of alkalies or antiseptics. 4. The wastes obtained from one ton of molasses thus yield, by fermentation and distillation, about 150 pounds of ammonium sulphate and more than 200 pounds of acetic, propionic, and butyric acids. It is not necessary to employ pure cultures of yeast or mold. Ordinary garden soil contains the germs required to set up the ammoniacal fermentation. Effront recommends sterilizing a mixture of earth and distillery waste by heating for an hour to 160 to 175 deg. F.; a treatment which does not kill the ammoniacal ferments. The sterilized mixture may then be used as a leaven to start the fermentation in other quantities of waste, but it must be renewed frequently.

FALL OF THE B. & O. SUSQUEHANNA BRIDGE.

BY WILLIAM ALLEN.

In the SCIENTIFIC AMERICAN of September 19 appeared an illustrated description of the new Baltimore & Ohio Railroad bridge across the Susquehanna River. Just four days later a portion of the structure fell, carrying with it several cars of a freight train crossing the bridge at the time. As a consequence of the accident, one of the most important sections of the structure must be entirely replaced, and traffic over it suspended until the work is completed.

From the statements of the crew of the freight train on the bridge and witnesses of the disaster, it appears that all heard a series of loud reports following each other in quick succession. Then came what they call a crashing sound apparently caused by the superstructure tearing away from its anchorages. The section which fell was 377 feet in length. Upon it were the frame traveler used in erection and twelve coal cars, each carrying fifty tons. The total weight this span was sustaining at the time of the collapse was about 700 tons, as nearly as can be estimated, in addition to the weight of the bridge material proper. In the fall to the river bed of nearly 100 feet, the metal and woodwork were twisted and wrenched into a tangled, shapeless mass of girders, posts, and other structural material. Most of the wreckage fell into the east channel of the river, between the island over which the bridge passes and the main shore, and was nearly submerged. The accompanying illustrations show its position before any of the debris was cleared away.

The portion of the bridge that fell was over what is termed the eastern channel of the river. As already described in the SCIENTIFIC AMERICAN, it was a deck truss with the tracks laid upon the upper floor. Each end rested upon the masonry piers of the original structure, which were being enlarged in proportion to the dimensions of the new superstructure. A platform or shoring of steel had been placed upon the tops of the piers to support it until the enlargement was completed. These piers and falsework in the river upheld the span. When the accident occurred, the superstructure "broke away," so to speak, from the piers, pulling the nearest rails from the track left on either side. The piers were uninjured, the damage being entirely confined to the superstructure. It might be added that an examination of the bridge remaining shows it to be intact and ready for train service when repairs are completed. The center of the coal train was carried away, leaving the locomotive and four cars on the east and six cars on the west side. The train was thus wrenched apart in two places, the center cars going down with the bridge.

At the time of writing two theories have been advanced as to the cause of the trouble. One is that the wreck was due to charges of explosives arranged in such a position that they wrenched apart or loosened the main supports of the span which gave way. Another theory is that the heavy coal train proved too much for the falsework. The bridge, however, has been in course of erection for over a year; and during this time train service has been maintained continuously. As this division of the Baltimore & Ohio connects New York, Philadelphia, Baltimore, and Washington, passenger and freight traffic is very extensive, and about seventy trains of the largest type of passenger and freight cars have passed over the structure daily, without its giving any indication of weakness. It may be added that the falsework was designed especially to sustain a weight largely in excess of any which might pass over the bridge. While the original piers were left to aid in supporting the new superstructure until replaced by the larger piers, the temporary falsework by which the piers were reinforced had been carefully designed, and none of the timber was subjected to stresses above those usually allowed

in work of this character. The loading per pile was ten tons.

It is needless to say that immediately after the disaster engineers of the American Bridge Company, contractors for the work, and of the Baltimore & Ohio

structure tore away from its fastenings. As already stated, these reports or explosions came immediately before the bridge fell. The engineer of the train on the bridge said they sounded like short thunder claps. They were so loud that they were heard distinctly in



In This Wreck Are the Temporary 377-Foot Span, the Falsework, and 12 Loaded Coal Cars.

Railroad Company were on the spot, and made an examination of the portions standing and of the fallen mass. The SCIENTIFIC AMERICAN can say on the authority of Chief Engineer Carothers of the railroad com-

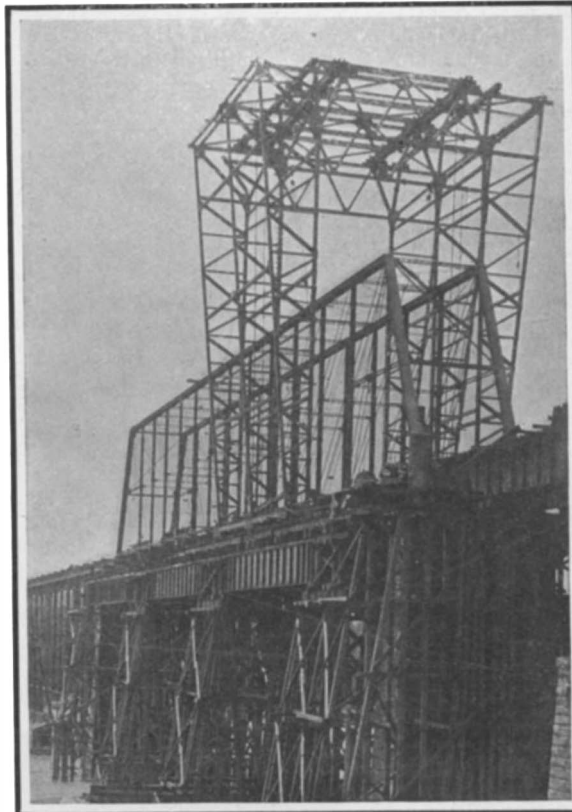

Traveler for Removing and Erecting Trusses.

pany, who made a personal investigation, that thus far nothing whatever has been found in the falsework or permanent construction to indicate that the trouble was due to any weakness or defective workmanship.

As to the theory that explosives were used, the peculiar sounds have not been accounted for. These were entirely distinct from the noise made when the super-

the towns on either side of the river, and after them came the crashing noise as the structure gave way. It might be added that guards have been placed on and in the vicinity of the structure for some time past, as the construction company, which employs non-union men, claims it feared that damage might be done by persons opposing its policy.

The work is one of the most extensive being undertaken in the United States, the length of the bridge being 7,000 feet. It is to sustain two tracks, and the metal construction alone comprises 20,000 tons of steel, some of the girders in the section which collapsed weighing 85 tons. Consequently this part represented less than five per cent of the total length of the bridge and about the same proportion of the total weight, or 1,000 tons, excluding the coal cars and traveler, which, if added, would make a total of 1,700 tons.

The Current Supplement.

The current SUPPLEMENT, No. 1710, is opened by B. S. Bowdish with an instructive and entertaining article on our fly-catchers, copiously illustrated. In three papers during the past two years Prof. T. J. J. See of the United States Naval Observatory has dealt with the cause of earthquakes and mountain formation, and has developed a new theory, according to which mountains are due to the secular leakage of the ocean through its bed. His further researches on the subject are briefly summarized in the current SUPPLEMENT. Thomas Oxley writes on some seventeenth and eighteenth century bottles. Aeroplane building has become an industry in France. A brief illustrated article gives one a glimpse of an aeroplane factory. Dr. Francis Darwin's striking paper on the movements of plants, in which he proposes the theory that the growth of the individual and the evolution of the race are processes of what may be called unconscious memory, is concluded. The part played by industrial dust in disease is briefly described. A thorough explanation of pneumatic caissons is given by Mr. T. Kennard Thomson, the well-known New York engineer. He shows clearly how they are used in the construction of tall buildings. The article will be published in two or three numbers of the SUPPLEMENT. Alfred A. Wohlauer contributes an excellent discussion on the present status of the flaming arc lamp. Among the minor articles may be mentioned those on the Tantalum Detector for Wireless Signaling; Power Measurement of Engines; The Carnot Cycle; The Development of Invention. The usual Science Notes, Engineering Notes, and Trade Notes and Formulæ, will be found in their accustomed places.

Aeronautics at Home and Abroad.

On September 28 Wilbur Wright made a flight of 1 hour, 7 minutes, and 11 4/5 seconds, and covered a distance variously placed at 32 to 36 miles. The next day he made two flights with a passenger, the first lasting 11 minutes and 36 2/5 seconds, and the second lasting 6 minutes and 15 seconds. The large gold medal of the Aero Club of France has been given to the Wrights.

Orville Wright's time for delivering a military aeroplane to the United States government has been extended to June 28, 1909.

Henry Farman on October 2 flew 40 kilometers or about 24 miles, at the rate of almost 54 miles an hour. This is said to be the world's record for speed.

The Aeronautic Society has decided to hold a contest on November 3 (Election Day). Octave Chanute has offered first and second prizes of respectively \$50 and \$20 for the best gliding performances.



View of Wreck from Opposite Side to That Shown Above.
FALL OF THE B. & O. SUSQUEHANNA BRIDGE.

THE SUN'S RADIATION AND ITS STUDY.
BY HERBERT T. WADE.

The late Dr. S. P. Langley, who was secretary of the Smithsonian Institution and the founder and first director of its Astrophysical Observatory, as a result of his study of the radiation from the sun believed that investigations in this field would eventually lead to the discovery of means of forecasting the weather, or more accurately, the climatic conditions of the earth, for some time in advance. The brilliant studies carried on at this observatory since its foundation in 1890 have done much toward realizing this promise and toward establishing evidences of the relations of the sun to climate and life upon the earth. The work so auspiciously begun at the Astrophysical Observatory was not interrupted by the death of Dr. Langley in 1906, and since that time it has been carried on with marked progress. Recently there has been published Volume II of the Annals of the Astrophysical Observatory, which gives a detailed account by C. G. Abbot, director, and F. E. Fowle, Jr., aid, of the investigations made in the period 1900-1906. During this time the principal problems that have attracted the attention of the observatory have been the "solar constant" of radiation, the relation of radiation to terrestrial temperature, and the radiation of different parts of the sun's disk, together with many incidental matters naturally involved in these investigations.

Now, by the term "solar constant" is meant the amount of radiation or heat emitted by the sun, as it would be found if measured outside of the earth's atmosphere at mean solar distance, and as a unit of measurement there is taken that intensity of radiation which when fully absorbed for one minute over a square centimeter of area placed at right angles to the ray would produce heat enough to raise the temperature of a gramme of water 1 deg. C., or expressed in C. G. S. units, one calorie.

This determination of the amount of heat transmitted to the earth by the sun is one of the most difficult as well as the most important in astronomical physics, and it has been termed by Dr. Langley the fundamental problem of meteorology; for if once it is possible to know the original quantity and kind of this heat, its effect on the constituents of the atmosphere on its journey to the earth, how much of it reaches the soil, how through the aid of the atmosphere it maintains the surface temperature of our globe, and finally how in diminished quantity and altered kind, it is finally returned to outer space, it will be possible to predict nearly all of the phenomena of meteorology.

The question of climate depending on the amount of radiation received was first clearly indicated in examining the records made late in March in 1903. At this time

there was observed a decline in the intensity of the solar radiation and this was followed by a marked and general decline in the temperature of the North Temperate Zone as compared with the mean temperature for the same month for many years.

solar radiation have been advanced, based on more or less experimental matter, but at best very little positive or satisfactory information had been secured, and it was not known whether the radiation sent to the earth by the sun was a constant quantity or varied considerably. Consequently, not only the intensity of the sun's radiation which reaches the earth must be determined, but how and why it varies, and especially its alteration in quality and quantity during its passage through the atmosphere, apart from its obstruction by visible clouds. Now for such measurements it would be desirable first to start at sea-level and then make other observations at various altitudes, rising if possible to the extreme heights only reached by unmanned balloons. But such is obviously impossible, as the work requires all the adjuncts of the most refined instrumental work and a laboratory, and accordingly two stations were selected for observations, one the Astrophysical Observatory on the grounds of the Smithsonian Institution at Washington, D. C., practically at sea-level, and the other some 3,000 miles away at the Carnegie Institution's solar observatory on Mount Wilson, Cal., at an altitude of 6,000 feet. The observations involved two main tasks—the measuring of the total intensity of the radiation at the earth's surface, using the pyrhelimeter, and secondly, the measuring of the energy in different parts of the solar spectrum using the spectrolometer. The necessity for ascertaining the intensity of radiation in different parts of the spectrum is due to the fact that the various wave-lengths of light in their passage through the atmosphere from the sun to the earth are affected differently, so it is necessary to consider the different spectral rays separately. For making observations it is of course desirable to select a day free from cloudiness, and occasionally simultaneous observations could be made at Washington and at Mount Wilson, the latter station being more than a mile above sea-level. Now the intensity of radiation actually observed at Washington was only about three-fourths as great as that observed on Mount Wilson, so that the difference furnishes data for determining the effect of the denser and lower atmosphere on the transmission of the solar radiation and with this as a basis determining the total effect of the atmosphere.

The observations with the pyrhelimeter and the bolometer are made during the day simultaneously at various altitudes of the sun, as at different times obviously the solar rays will pass through varying amounts of atmosphere, from a minimum at noon, when the direction of the radiation is practically perpendicular to the surface of the earth, to that occurring at other altitudes of the sun when the path is through a much greater length of the dense atmo-

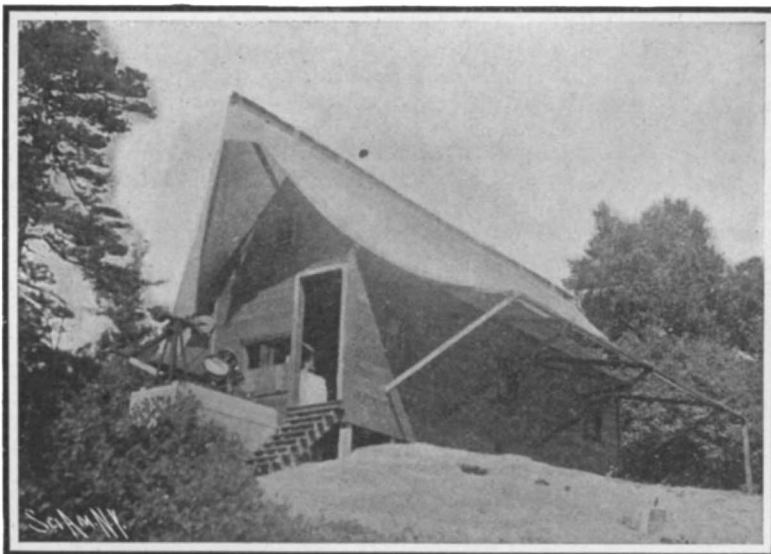

The Shelter for the Bolometer.

When computed and critically studied the observations seem to show that the decline in temperature was in remarkably close agreement with that which should follow a real decrease of the solar radiation. This, therefore, seemed to indicate not only the variation of the solar radiation but also its effect upon climate and its applicability to forecasting weather conditions. Various theories as to the amount and nature of the

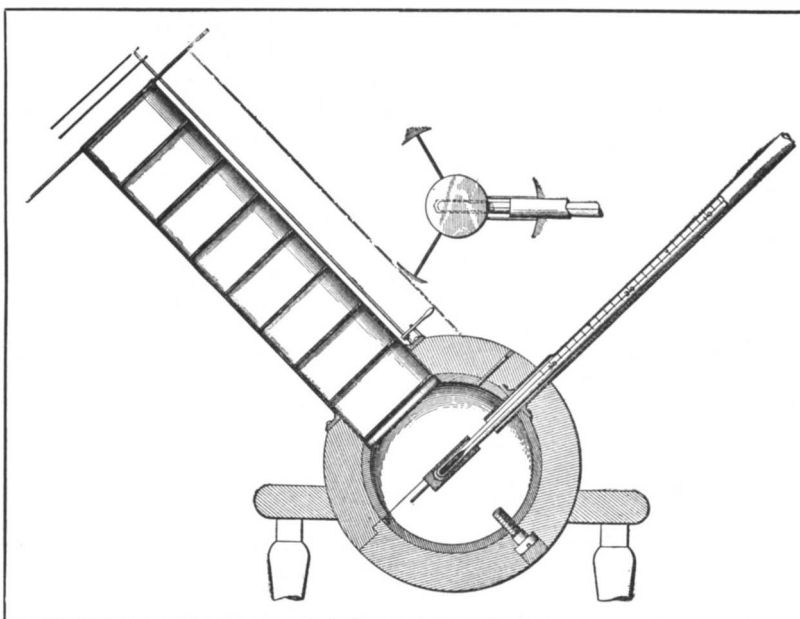

Details of the Pyrhelimeter.

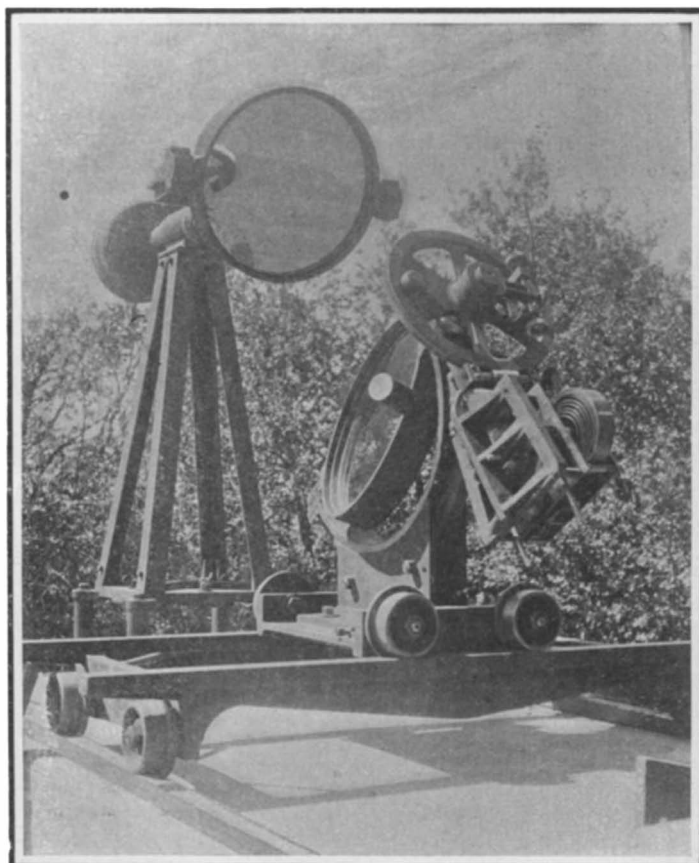

The Heliostat Reflecting the Solar Rays to the Bolometer.

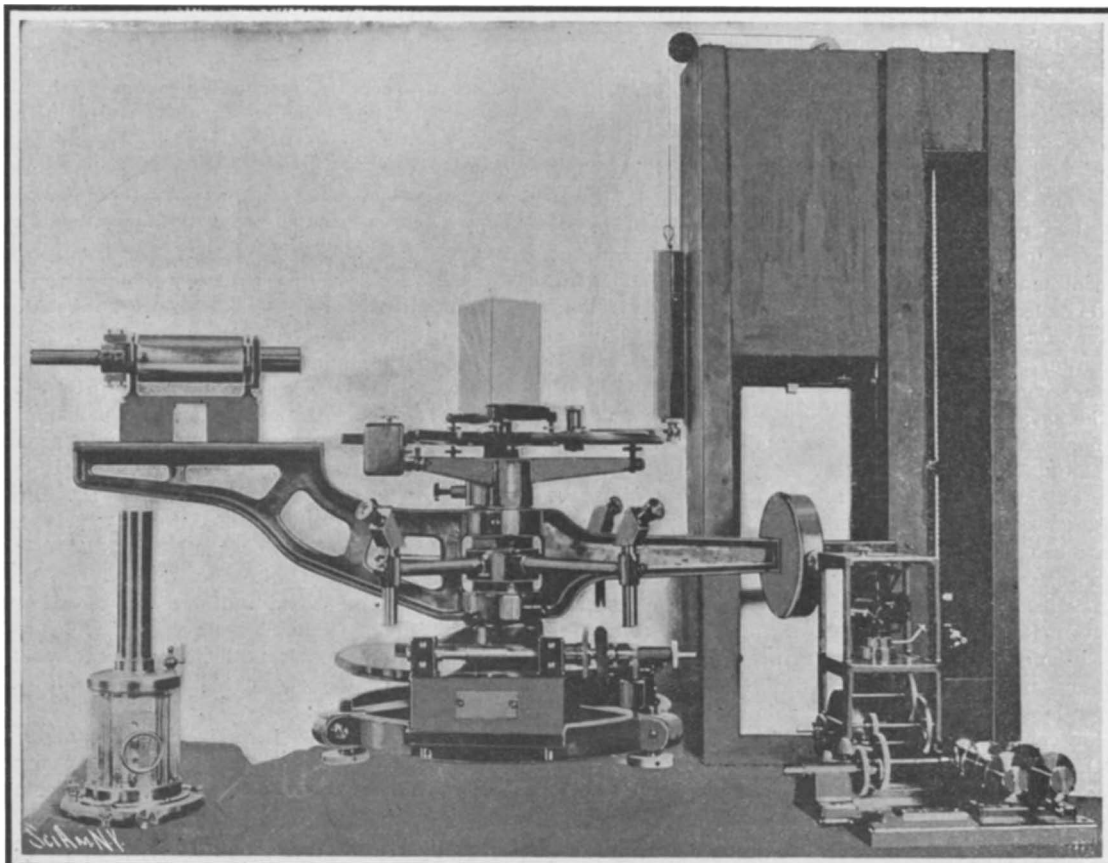

The Spectrolometer, an Instrument that Measures the Energy in Various Parts of the Solar Spectrum.

sphere near the earth's surface. Now the bolometer is simply a most delicate form of thermometer adapted to measuring the energy heat in the various parts of the spectrum, not only in the visible portion, but wave lengths extending considerably beyond into the ultra-violet at the short end or to wave length 0.37μ , and to 2.5μ in the infra-red part of the spectrum where the long or heat waves proper are found. It consists of a fine wire of blackened platinum on which the radiation falls after passing through a prism to be separated into its component rays. The rays are received from the sun by a cœlost, consisting of two adjustable plane mirrors, one of which is so mounted and operated by clockwork that it follows the motion of the sun and reflects its rays to the second or fixed mirror, from which they pass to the slit of the spectroscopy after being reflected from a concave cylindrical collimating mirror, which renders the rays parallel before they are passed through a flint glass prism for dispersion. After reflection from two plane mirrors the rays pass to the bolometer, and any variation in the resistance of the platinum wire which serves one arm of a Wheatstone bridge is indicated by a reflecting galvanometer. The galvanometer used for this work is a 16-coil reflecting galvanometer, modified from the familiar Thomson type, and with it is employed the usual beam of light and a photographic dry plate moved by clockwork on which the movements of the galvanometer needle are recorded. When in operation the prism is rotated by clockwork so as to bring successively the radiation peculiar to the different parts of the spectrum on the platinum wires of the bolometer, whose resistance naturally varies with the intensity of the radiation received, causing the movements of the needle to make a record in the form of an irregular curve on the sensitized plate. The bolometer does not determine the total amount of radiation received in terms of an absolute or known and invariable scale of energy, but by studying and standardizing its relative measurements, results are obtained which can be used to determine either the absolute magnitude or the changes of the solar radiation outside the atmosphere.

As the bolometer is used in connection with the pyrheliometer, it is necessary to understand the essential operation of this instrument. It, too, is a thermometric device, but it measures the total quantity of heat received. Various forms of pyrheliometer have been devised and tried in these experiments. Of the older types the most useful is one where the bulb of the thermometer was immersed in mercury, placed in a small hole in a blackened copper disk at the center of the copper sphere. The copper disk was exposed to the direct radiation of the sun and accordingly the thermometer received and indicated the total heat energy received. This form of instrument had various shortcomings, as did also the other pyrheliometers and actinometers tested, so that it was found necessary to devise a new and standard pyrheliometer. In this instrument the solar beam was received in a blackened chamber, around which water at a constant temperature was permitted to pass. Now it was possible to measure the increase of heat received by this water in flowing around this chamber by means of a platinum resistance thermometer with the usual arrangement of galvanometer and Wheatstone bridge. Then by heating the chamber from a platinum resistance wire, it could be ascertained how much heat must be introduced to produce the same effect. In this way the total heat energy falling on the standard pyrheliometer could be determined. This instrument was tested thoroughly by itself and with other pyrheliometers so that it was possible to determine with high precision the relative accuracy of the measurements, but there was some uncertainty amounting to a little more than one per cent of the absolute value of the measurement made with the standard instrument. Nevertheless when the pyrheliometer and the bolometer were used together, a most satisfactory determination of the heat energy received at the earth's surface could be obtained.

The mean result of 130 measurements made with such apparatus in the summer and autumn of 1905-6 on Mount Wilson, fixes the intensity of the solar radiation outside the atmosphere at mean solar distances at 2.023 calories per square centimeter per minute. The mean result of forty-one similar measurements at Washington extending over the period from 1902 to 1907 is 2.061 calories. A critical study of the measurements makes it probable that if they were conducted for a long term of years the mean value would be higher, and accordingly 2.1 calories per square centimeter is estimated as the probable mean value of the "solar constant." In other words the heat sent out to the earth from the sun in the course of the year is capable of melting an ice shell 35 meters (114 feet) thick over the whole surface of the earth.

This new value for the "solar constant" is somewhat less than that obtained by Langley from his Mt. Whitney observations, 3 calories, but the investigators in charge of the more recent work have been able to trace certain errors in Langley's conclusions and have discussed his observations in the light of further de-

velopments so that the value of the "solar constant" they obtain from his observations agrees very closely with that from their own observations. This is particularly interesting, as it enables observations made on a high mountain, Mt. Whitney, whose height is 3,500 meters (11,483 feet), to be compared with the Mount Wilson and Washington observations. It has been proved that the solar radiation is not a constant quantity but that it varies with the decrease in the solar distance and this may amount to $3\frac{1}{2}$ per cent from August to October. Other changes occur from month to month and from year to year, though the mean value represents the average condition of the sun. It is, however, also proved that the variation in the solar radiation is due to changes in the source of radiation rather than to the effects of the atmosphere or external causes.

With the assumed value of the "solar constant," 2.1 calories, it is possible to study and explain the temperature of the earth, and it was found that the actual temperature was in close agreement with that which would follow from the assumed value. The amount of reflection or the albedo of the earth for light and heat from the sun was determined at 37 per cent, and on this basis the "solar constant" could not exceed 2.33 calories, or otherwise the earth would be a perfect radiator and better than the "absolute black body" which is taken as a standard of radiation. Now the surface of the earth is covered with clouds and water vapor which interfere with terrestrial radiation, and its temperature is maintained very nearly constant by means of the water vapor layer at an elevation of four to five thousand meters. The earth as a planet reflects 37 per cent of the radiation that it receives, and of the 63 per cent absorbed, 45 per cent is absorbed either at the earth's solid and liquid surface or in the atmosphere within a mile of sea-level.

For purposes of comparison the investigators have considered the radiation that would act on a "hypothetical earth," assuming for it the same dimensions and motions as the real earth but making it hollow and like a soap-bubble in thickness of wall, making it absorb solar radiation perfectly and also radiate perfectly the long waves in addition to conducting perfectly heat along parallels of latitude and being a perfect non-conductor for meridians of longitude. For such an earth was calculated a temperature at all latitudes and at all times of year, making use of the known value of the "solar constant" and the laws of radiation of perfect radiators. The discussion of this "hypothetical earth" afforded an explanation for many meteorological phenomena, and a comparison extending over thirty years of the temperatures at 47 stations at different points on the land surface of the globe seems to indicate that changes of solar radiation often do produce well-marked and recognizable changes of temperature with considerable certainty. In the course of these rather elaborate investigations many incidental observations of great value were made. For example, by measuring the distribution of brightness over the sun's disk, considering especially the difference between the center and the edge, it was found that changes in the solar radiation were attended by a variation in the transparency of the outer envelope of the sun and are possibly due to fluctuations in this transparency. Of course such results of observations as the transparency of the upper and lower strata of air, the reflective power of the clouds, the probable temperature of the sun and the quality of the radiation of its sunspots were all valuable incidents to this work, and the relation of the sun to climate and life on the earth is one that now stands in a fair way to be determined and understood with much greater accuracy and on a much more intelligent basis than ever previously.

The Tuberculosis Congress Proceedings.

That tuberculosis in its early stages can be cured has been announced more than once in late years. The statement was reiterated in more than one paper read before the Sixth International Tuberculosis Congress at Washington. Among those who spoke on this subject were Prof. M. A. Barber of the University of Kansas, who spoke for himself, and Dr. Gerald Buell and Dr. W. S. Williams of Colorado Springs, Prof. A. Calmette of the Pasteur Institute, Lille, France, and Dr. Edward R. Baldwin of Saranac Lake, N. Y.

Dr. Ishigami, director of the Ishigami Institute, at Osaka, Japan, declared positively that by the use of a serum tuberculosis patients can be almost without exception completely cured in from three to six months. He said:

"After continuous investigations for more than ten years I have succeeded in getting two remedies of comparatively great efficacy and free from any detrimental reaction.

"1. The one is a chemical preparation from tubercle bacilli and is applicable to incipient and feverless patients.

"2. The other is an immunization serum and is applicable chiefly to patients in an advanced stage of the disease.

"Tuberculo toxoidin, the first, is a preparation made by chemically dissolving the tubercle bacilli and transforming the toxic property, thus getting rid of the reaction which is the common detriment of all the other preparations from tubercle bacilli.

"The incipient and feverless tuberculosis patients can be, almost without exception, completely cured within from three to six months by the injection of this preparation.

"In patients in more or less advanced stage, if the nutrition is in good order, similar results can be obtained. In feverish patients a satisfactory result is often obtained by means of the injection used side by side with antipyretics. In more serious cases, beyond a certain degree, it is quite useless.

"Out of the total of 772 tuberculosis patients, each of whom has received more than fifteen injections of tuberculo toxoidin in my clinic within the last few years, there were 274 who were completely cured and 258 who were partially cured. These last two figures added together made 532, being 68.91 per cent of the total number of patients. Those who discontinued the treatment on various reasons numbered 107. Those who died numbered 29, and the remnant numbered 104.

"Satisfactory immunity to tuberculosis has only been obtained experimentally by the use of living bacilli. Any successful method of producing freedom from tuberculosis must be sought through the use of the living germ.

"The idea was first carried out by mice and anthrax germs. Encouraged by results, guinea pigs, animals very easily rendered victims of tuberculosis, were inoculated with the germ of tuberculosis. About forty guinea pigs have received inoculations, beginning with one live tubercle bacillus and increasing up to thousands; so far none, as proved by post-mortem examinations, have become victims of tuberculosis."

Benjamin C. Marsh, executive secretary of the committee on congestion of population in New York city, read a paper on "Town Planning in Relation to the Anti-Tuberculosis Campaign." He said in part:

"Town planning involves the determination by the city of the lines of its development. It means that the city sets a standard for density of population which, while recognizing the values which the inner sections have acquired through the unrestricted and hence too intensive use of land, grades the use to which land may be put to secure as near as possible to the city center a requisite standard of living and work for its population.

"Fresh air, rest and good food is the standard emphasized over and over again in this tuberculosis exhibit, and they are essential to the prevention of tuberculosis. It is difficult to inject fresh air into tenement house blocks with a density of 500 to the acre. New York has many blocks with a density of 1,000, which cover from 65 to 75 per cent of the site.

"No effective warfare can be waged against tuberculosis without a systematic plan for the development of every city and could adopt a standard of the number of cubic feet of air space and admit that natural light should be provided for all workers in factories, stores and offices."

Washington, despite its beauty, was branded as a disgrace; and Paris is even worse.

Mr. Jacob H. Schiff made a strong plea for the compulsory treatment of advanced consumption by the State or municipality. Mr. Schiff summarized his conclusions as follows:

"That the private hospital and sanatoria exclude from admission advanced and incurable consumptive patients.

"That the State make ample and adequate provision for the proper care of sufferers from advanced and incurable consumption, and that the isolation of phthisis sufferers in advanced stage be made compulsory by law, though in a manner which shall accomplish this with the greatest possible consideration for the sensibility of the patient.

"That ample provision be made in sanatoria and otherwise for the scientific treatment of the consumptive in the early and curable stage of the disease, both through private philanthropy and by the State.

"That a thorough system be organized through which can be disclosed the existence of cases of weakened constitutions and anæmic conditions in children and young persons, especially in families afflicted with consumption."

It is interesting to note that the slide rule, which but lately has become universally used for calculations, was invented nearly 300 years ago. An article in *Zeitschrift für Vermessungswesen* calls attention to the fact that Gunter, shortly after his bringing out the trigonometric logarithmic tables in 1620, placed logarithmic scales on wooden rules, and used a pair of dividers to add or subtract the logarithms. In 1627 these logarithmic scales were drawn by Wingate on two separate wooden rules, sliding against each other, so as to render the use of dividers unnecessary, and in 1657, or over 250 years ago, Partridge brought out the slide rule in its present form.

Correspondence.

Some Myths Exploded.

To the Editor of the SCIENTIFIC AMERICAN:

In your issue of September 26, page 203, one of your contributors says:

"That the sun and planets revolved round the earth was once a common belief. Giordano Bruno knew otherwise, and for so saying was (about 1600) burned at the stake. . . . Today his theory is an accepted fact."

There are at least two misstatements here:

1. Bruno was not put to death for saying that the earth revolves around the sun, nor was anyone else ever put to death for saying so.

2. It was not "his" theory, unless in the sense that it is the theory of every schoolboy who hears it and accepts it. It was the theory of Pythagoras. It may be called the theory of Nicolas de Cusa, since he revived it; he was born in 1401, and was made Cardinal by Pope Eugenius IV. in 1448. It was the theory of Copernicus; from him it gets its name. He put more clearly than anyone who ever lived before him, all the arguments that could then be given in its favor, and made the theory appear more probable than ever before. He was born in 1473. A disciple of his, Widmanstadt, expounded his theory before Pope Clement VII. in 1533. Copernicus dedicated his great work on the revolutions of the heavenly orbs to the reigning Pope, Paul III., in 1543, five years before Bruno was born.

Bruno discovered no new arguments in support of the Copernican theory, and he was incapable of putting the old ones more clearly than others. He may be called a rhetorician, but hardly a scientist. The chief characteristic of his writings is fog.

Barbieri ("Neapolitan Mathematicians and Philosophers," page 119) says: "His powerful imagination veiled his intelligence, and he reasoned like a person in hysterics."

Bailey ("History of Modern Astronomy," vol. v., page 531, Parma, 1794) says: "Bruno knew only enough astronomy to explain the sphere."

Poughkeepsie, N. Y. J. F. SHEAHAN.

To the Editor of the SCIENTIFIC AMERICAN:

Will you please allow me to object against an unscientific remark made in the SCIENTIFIC AMERICAN of September 26, page 203, in the article entitled "A Few Suggestions for Inventors of Safety Devices," by Edwin Phillips. The remark reads as follows: "That the sun and planets revolved round the earth was once a common belief. Giordano Bruno knew otherwise, and for saying so was (about 1600) burned at the stake and his ashes cast to the winds." The first sentence is historically correct; the second historically incorrect, and consequently unscientific.

In your own Encyclopedia Americana, art. "Bruno Giordano," you have the words: "After an imprisonment of two years [ought to be six years], that he might have opportunity to retract his doctrines, he was burned for apostasy, heresy, and violation of his monastic vows." The only other remark made in the Americana in the same article on the system of Copernicus says: "But his inference that the world is infinite and immeasurable and his doctrine of the plurality of worlds at the moment when the new system of Copernicus was attacked from all quarters, could not but be looked upon as a crime."

In the Catholic Encyclopedia, William Turner, B.A., S.T.D., Professor of Logic and of the History of Philosophy at the Catholic University of America, Washington, D. C., in the article "Bruno, Giordano," positively asserts: "Bruno was not condemned for his defense of the Copernican system of astronomy, nor for his doctrine of the plurality of inhabited worlds, but for his theological errors, among which were the following: That Christ was not God, but merely an unusually skillful magician, that the Holy Ghost is the soul of the world, that the devil will be saved," etc.

The Kirchenlexicon, Herder, Freiburg vol. II, page 1,369, art. "Bruno, Giordano," goes still farther and gives the twelve indictments lodged against Bruno, January 14, 1599, by the Roman Congregation. The indictments as given condensed by Schoppius read as follows:

"1, There are innumerable worlds; 2, the soul migrates from body to body, in fact also some to other worlds, and one soul can inform two bodies; 3, magic (witchcraft) is a good thing and licit; 4, the Holy Ghost is the soul of the world; 5, and this is what Moses meant to say when he writes: 'The spirit of God hovered over the waters'; 6, the world is eternal; 7, Moses worked his miracles by witchcraft; 8, Moses invented his laws; 9, the Scriptures are the property of everybody; 10, the Jews alone derive their origin from Adam and Eve, the rest of mankind from two others, whom God created the day before; 11, the devil will be saved; 12, Christ is not God but a skillful magician."

I fail to see where Mr. Phillips got his information,

and consequently cannot allow his remark to go unchallenged.

Rev. VICTOR STEPKA.

St. Paul, Mo., September 28, 1908.

[The above correspondents are correct in their criticism. The principal charge against Bruno was that he had broken his monastic vows and taught a pantheistic doctrine.—Ed.]

THE PAPER INDUSTRY AS RELATED TO FORESTS AND EDUCATION.

The great German chemist, Liebig, once said that the degree of a nation's civilization might be gaged by the amount of soap which that nation consumed. A similar epigram would truthfully hold good for paper consumption. The amount of paper used is a very good indicator of the educational development of a nation. The diffusion of newspapers, magazines, and books is one of the principal means for the dissemination of learning. For the purposes of comparison we have assumed that all news paper, book paper, writing paper, etc., has been run from the machines in a continuous web of paper adapted for a newspaper press of heroic size.

In the case of the United States this annual shaft of paper would be 830 feet high, 377 feet in diameter, and it would weigh 2,730,000 tons of 2,000 pounds. Germany, a great book and reading nation, comes next with a 937,000-ton roll 588 feet high and 267 feet in diameter. England follows with a roll 495 feet high, 225 feet in diameter, and weighing 573,000 tons, certainly a considerable quantity for an insular kingdom. France comes next with a 419,000-ton roll 445 feet high, 202 feet in diameter. Austria makes a good showing with her 346,000 tons, the roll being 418 feet high and 190 feet in diameter. Last of all the six great paper-producing countries stands Italy, whose annual production of paper amounts to 265,000 tons, the roll being 379 feet high and 172 feet in diameter. The aggregate amount of capital invested in all six countries is little short of a billion dollars. The analysis of materials and product is always interesting. In 1905 the raw materials consumed in this industry in the United States were as follows:

	Cords.	Value.
Pulp wood	3,050,717	\$20,800,871
	Tons.	
Rags	294,552	8,864,607
Old or waste paper	588,543	7,430,335
Manila stock	107,029	2,502,332
Straw	304,585	1,502,886
Sulphur	130,400	3,221,834
Other chemicals		5,111,546
Pyrites	2,036	31,925
Clay	201,218	2,096,570
Sizing	52,171	1,838,035
Fuel		13,178,567
Mill supplies		2,526,950
All other materials		11,034,537

Adding other elements of expense we have a grand total of \$111,251,478.

This large expense bill is offset by a valuable product which may be classified as follows:

	Tons.	Value.
News in rolls	840,802	\$32,763,308
News in sheets	72,020	3,143,152
Book paper	434,500	31,156,728
Cover paper	22,150	2,023,986
Plate, litho, etc.	19,837	1,458,343
Cardboard, tickets, etc.	39,060	2,764,444
Writing paper	131,934	19,321,045
Miscellaneous fine paper	14,898	2,928,125
Wrapping paper	644,291	30,435,592
Tissue paper	43,925	5,056,438
Blotting paper	8,702	1,046,790

Other forms of paper, such as boards, building paper, hanging paper, etc., bring up the total in round numbers to 2,730,000 tons. This figure, which is derived from statistics compiled exclusively for the SCIENTIFIC AMERICAN, differs somewhat from the census figures of 1905. The total value of the products of all kinds in 1905 was \$188,715,189; the total expenses were \$165,807,763, leaving a profit of \$22,907,426, or 8 1/3 per cent on the investment. This is certainly a small enough return on the capital invested.

We now come to another interesting phase of the subject, that is the destruction of the forests. We hear a great deal about our forests being rudely grabbed by the insatiable pulp maker. Now, as a matter of fact, less than 3 per cent of the timber cut ever enters the pulp mill. This figure is more than conservative, and is vouched for by expert foresters. The possibility of a dearth of wood has caused some of the largest and most conservative mills to lay aside large tracts of land for reforestation and for every cord of wood consumed now a forestry charge is sometimes added, as follows, to pay for growing and protecting timber for later consumption:

Year.	Cost per Cord.	Forestry Charges.	Total.
1900	\$4.92	..	\$4.92
1901	5.04	..	5.04
1902	4.83	\$0.55	5.38

1903	\$5.42	\$0.55	\$5.97
1904	5.93	.55	6.48
1905	6.10	.55	6.65
1906	5.95	.55	6.50
1907	6.39	.55	6.94

The whole question is admirably summed up in a letter, from which we quote the substance, to an official in the Forest Service, United States Department of Agriculture. This letter was written by the general manager of a group of mills. He says:

"We own one tract of land containing about 300,000 cords of growing wood, which cost us about \$225,000; we have taken practically no wood from this tract; the annual interest charges amount in round numbers to \$11,000, and to this amount must be added taxes, expenses of the Forestry Department for work spent on the tract, cost of keeping out fires, etc. All these expenses are charged to the tract at the end of the year, but if no wood is cut from the tract no charge can be made against manufacturing. The longer we hold the tract the greater the cost per cord, unless the growth is sufficient to take care of the carrying and Forestry Department charges, which accumulate at a very rapid rate; therefore, inasmuch as we have many tracts containing large amounts of growing wood from which we are cutting very little wood at this time, the ultimate charge against manufacturing will be heavy. It is almost impossible to estimate what this charge will amount to until we have had years of experience, and can compute our costs on the same basis that enables the life insurance companies to fix their premiums on policies. The same principle is involved. If we were not looking ahead to protect our mills, we could temporarily realize considerable profit by skinning our land, as is done in the lumber and other industries, but the situation with us is quite different from what it is with them. We have millions of dollars invested in works and machinery, and unless we conserve our wood supply our investment in plant is worth only what it will sell for as scrap. On the other hand, a lumberman owning a \$1,000,000 lumber tract can cut all the wood off in a \$20,000 sawmill, and when he has skinned his land he can either move his sawmill to another location or abandon it; his mill investment is small, and his loss amounts to little. You will, therefore, appreciate the fact that we must preserve our wood supply, and we are willing to go to any practical extent to create a perpetual supply of wood for our mills. This is the policy we have followed for some time past, and we shall continue to follow it so long as we can afford to do so.

"I have endeavored to bring the above facts before the Pulp and Paper Investigation Committee at Washington. There is no tariff on pulp wood from Canada, but there is a tariff on pulp and paper. Now, if this tariff on pulp and paper should be taken off, it would bring us into competition with Canadian and foreign mills where wood, or labor and other materials, can be secured at low prices, especially in Canada, where there is such an abundant wood supply as to make reforestry unnecessary for many years to come. This would result in forcing prices to a point where there would be but one course open to us, namely, to realize on our wood by skinning our land and then go out of business. I claim that any industry which must subsist on wood and which is reproducing the wood it consumes, thereby not reducing the forest area but maintaining it, should be encouraged and protected."

This certainly shows a very sane realization of the duties of society in conserving our natural resources. Nearly all mills owning large tracts of land have expert foresters who determine what timber shall be cut. The timber reservations are in constant danger from fire. At the time of writing, on one forest for eventual paper pulp consumption 300 men are employed in fighting fires and making timber-denuded zones to arrest the progress of the elements.

Drought is also a foe to the paper maker, as an abundance of water is required to wash the pulp. One mill with fourteen large paper machines is running with only two machines at the present time. The continued droughts of September have resulted in a serious curtailment of production. This taken in connection with labor difficulties has resulted in an extraordinary condition which is that the visible supply of paper for the newspapers of the country is only sufficient to last thirty days. Paper is being consumed for this purpose at the rate of 2,400 tons a day and the outlook is far from promising.

The paper industry is very interesting in all its phases and we have attempted to draw the attention of the reader to some peculiar facts concerning the same.

Engineering News describes a two-stage vacuum pump, capable of producing a vacuum within 0.02 inch of the barometric height, which is being used by makers of incandescent lamps. The pump is of the reciprocating piston and cylinder type with two cylinders of 12-inch diameter and 12-inch stroke. The valves are operated mechanically from eccentrics on the main shaft. The machine may be driven by belt or gearing, or is built with steam cylinders attached.

THE MULTIPLE AIR PROPELLER. ITS AERONAUTIC POSSIBILITIES FOR DIRIGIBLE AIRSHIPS, AEROPLANES, AND HELICOPTERS.

An air propeller is merely a plane surface moving through the air in a spiral path. According to a well-known law, the resistance offered by the air to such a surface increases as the square of the velocity. If a propeller of one square foot area, traveling at a speed of 20 miles per hour, meets with two pounds resistance, when driven at 40 miles per hour the resistance will be eight pounds. This law holds good for all practical speeds, although the recent experiments of M. Eiffel, the builder of the Eiffel Tower, tend to show that at extremely high speeds there is a slight variation. In the case of an air propeller, the resistance or pressure of the air against its blades constitutes the thrust of the propeller, and this thrust increases with the square of the velocity.

But in order to double the speed of the propeller, eight times the horse-power is required, since the horse-power needed to drive such a propeller increases as the cube of the propeller's speed. The accompanying curve shows this. Up to a certain point, such as A, the thrust is fairly efficient, but beyond this point the gain in thrust obtained per unit of horse-power is out of all proportion to the energy expended.

In order to overcome this difficulty, two inventors on opposite sides of the Atlantic have independently conceived substantially the same idea of using, instead of a single large propeller, a number of small propellers of relatively low speed and consequently developing the maximum thrust per unit of horse-power. One of these inventors, Mr. E. V. Hammond, of London, England, has constructed such a multiple propeller and has conducted a series of valuable experiments. The other inventor, Mr. Wilbur R. Kimball, has constructed a helicopter, the lifting propeller of which is constructed on the multiple principle. Mr. Hammond's experiments seem to show that by increasing the number of propellers, the thrust can be increased directly as the horse-power. Consequently, a large thrust can be obtained with much less horse-power than would be required were one or two large propellers used.

A single propeller of very large area running at a very slow speed would give the same results as the system of small multiple propellers; but such a propeller would be so heavy and cumbersome as to be practically out of the question when a large horse-power is to be used. Moreover, every part of the single propeller's effective area is revolving at a speed different from that of every other part, thus considerably diminishing its efficiency. On the other hand,

with small multiple propellers of light construction, the pressure is practically the same over the entire blade area, and besides this there is a great saving in weight.

In order to show how much increase of thrust is obtained per unit of horse-power by the multiple propeller arrangement, the following concrete examples may be given: A two-bladed propeller having an

radii of gyration, the same thrust will be obtained with an absorption of only 0.63 horse-power ($0.105 \times 6 = 0.63$). If the metal propeller is made stronger and its speed is increased to 75 miles an hour, a thrust of 28 pounds is obtained with an absorption of 5.5 horse-power, while fourteen of the small propellers revolving at 20-mile speed will give the same thrust with a total absorption of 1.47 horse-power.

These figures give the power absorbed by the propeller blades in both instances. On account of their small weight, the additional horse-power required by the multiple propellers for their extra bearings is so small that it may be neglected in the comparison.

Mr. Kimball has not approached the subject in the same way as Mr. Hammond, but has empirically worked on the theory that better results can be obtained from a large number of small propellers, arranged in the same plane and

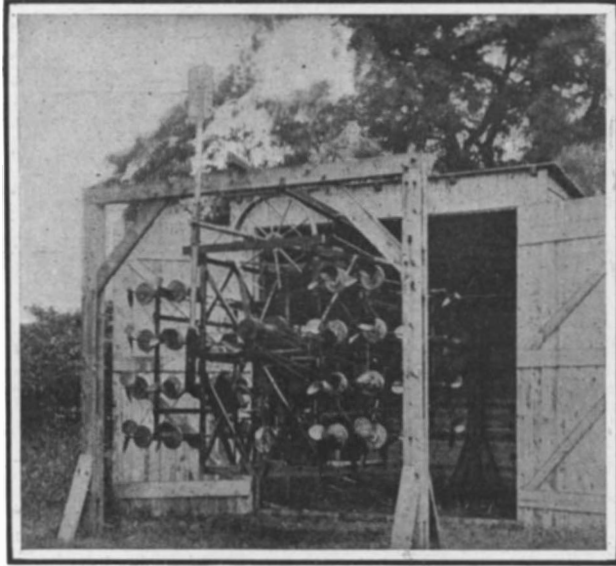

The small propellers which collectively take the place of the single 9-foot large propeller are mounted on 1/4-inch shafts, three on a shaft, with eight shafts on each side of the framework of the car. All eight shafts are driven by round leather belting and pulleys from the central countershaft. The aggregate area of the small propellers is 19 square feet. That of the single big propeller is 2 square feet.

Three-quarter View of the Hammond Multiple Air Propeller.

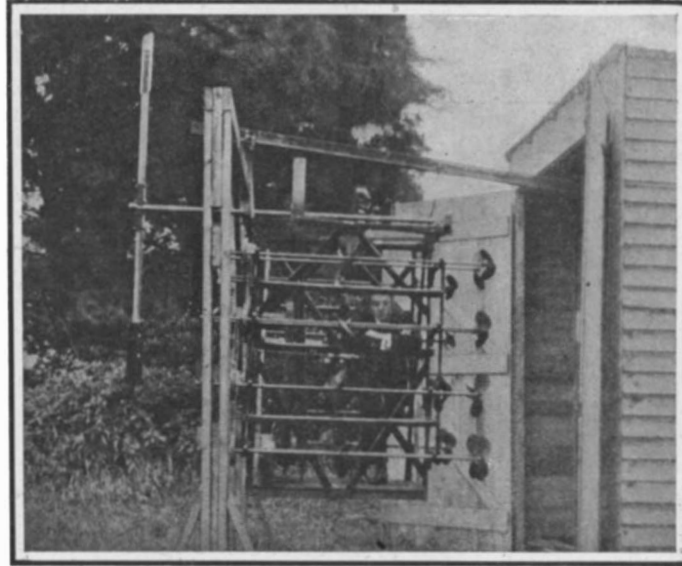

The framework of the car is 7 feet high and 5 feet square. It carries at its front end a large two-bladed propeller having an effective blade area of 2 square feet and driven by a belt at a speed of 60 miles an hour at the radius of gyration of the blades. The total weight of the propeller, its shaft, and pulley is 180 pounds. The total weight of the multiple propeller system taking its place is only 150 pounds.

Side View of Hammond's Multiple Air Propeller.

effective area of one square foot, and the blades of which are set at an angle of 45 deg., if run at a speed of 20 miles an hour at its radius of gyration will exert 2 pounds thrust with an absorption of 0.105 horse-power. Because of its low speed and small thrust, this propeller can be made very light. It can, for instance, be constructed of goldbeater's skin stretched on a light aluminium frame. A single large propeller, designed to exert the same thrust as a given number of such small, lightly constructed propellers,

revolving at a fairly high speed. As can be seen from the accompanying photographs showing his theory embodied in a helicopter, his propellers are arranged in a light framework 26 feet wide and 17 feet long from the front to the rear. There are twenty four-bladed wooden propellers, 4 feet in diameter and having a 2-foot pitch. This low pitch makes it possible to drive them frictionally at over 1,000 R. P. M. by means of a small 1/8-inch wire rope in contact with half of a 19-inch grooved pulley on each propeller. The frame which carries the propellers is set at an angle of 20 deg. with the horizontal. This angle is sufficient to give fairly rapid forward motion to the helicopter as soon as it rises off the ground. Theoretically, with an angle of 15 deg., a forward thrust equal to 25 per cent of the lifting power is obtainable, while the reduction of lift over what would be possible with the propellers placed horizontally is only 3 per cent. It is possible for the aviator to vary the inclination of the propellers with the horizontal by shifting his position slightly, or by moving the horizontal rudder placed along the rear edge at the highest part of the machine. At first Mr. Kimball expects to have this rudder stationary, as shown in the photographs, and he believes that it will maintain the fore-and-aft equilibrium automatically to a considerable degree. There are also a number of vertical rudders at the rear for the purpose of steering.

The helicopter is driven by a new type of four-cylinder, two-cycle motor, which is said to develop 50 brake-horse-power at 2,000 R. P. M.

The total weight of the helicopter, without the aviator, is about 500 pounds, so that, including the weight of a man (150 pounds), it is required to lift only 13 pounds to the horse-power in order to ascend.

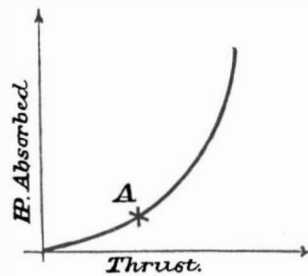

The Thrust of a Propeller Does Not Increase Commensurately with Increased Horse-Power.

would necessarily be made of metal, because it could not otherwise withstand disruption by centrifugal force.

Let us suppose that we desire to obtain a thrust of 12 1/2 pounds. In order to obtain this, it would be necessary to run the large propeller at a speed of 50 miles per hour at its radius of gyration. The horse-power required to drive it at this speed will be 1.64. If, in place of the large propeller, six small propellers be used, running at 20 miles per hour speed at their

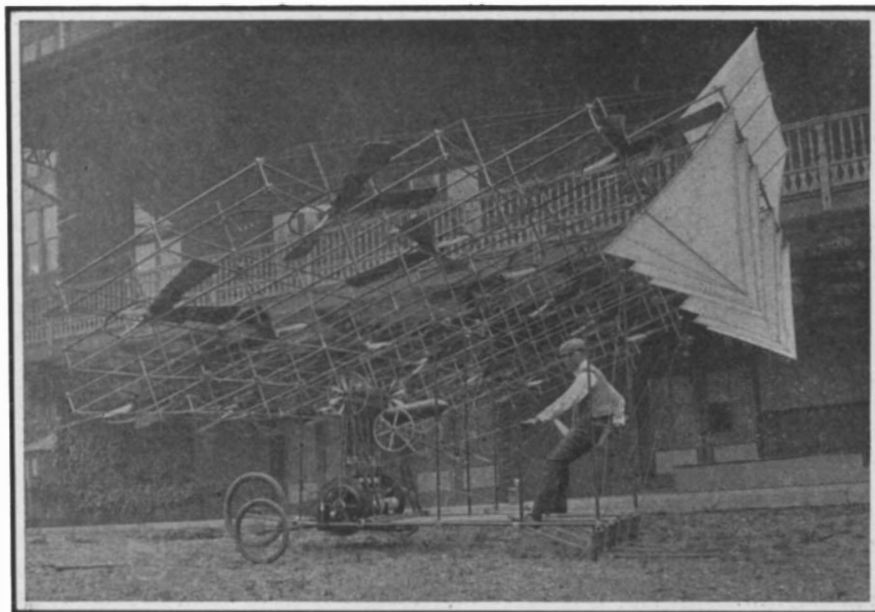

The machine is carried on bicycle wheels at its forward end and on skids at the rear end. On a control board in front of the aviator are a number of levers by means of which he can cut out any or all cylinders.

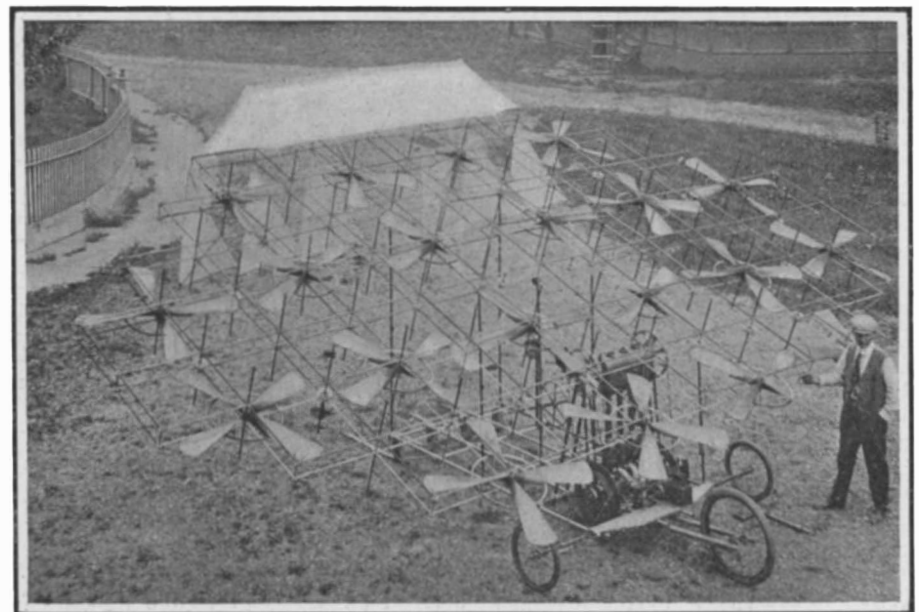

All the moving parts run in ball bearings. The friction is so slight that the pressure of a finger on the starting crank of the engine turns all the propellers.

THE KIMBALL HELICOPTER IN WHICH THE LIFTING SCREWS CONSIST OF A NUMBER OF SMALL PROPELLERS.

THE NAVAL STORES INDUSTRY.

BY DAY ALLEN WILLEY.

The Naval Stores industry is one of the most recent in the United States. It is only during the last decade that turpentine and rosin have been produced in considerable quantities. In 1890 Florida, one of the leading States in the industry, produced less than \$200,000

It is needless to say that the site of this industry is confined to a very small portion of the United States, a great majority of the stills being located in Georgia and Florida adjacent to the forests of yellow and loblolly pine which yield most of these products. While South Carolina contributed a large proportion of the product during the first few years of the industry, its

being made much deeper than actually necessary. In the effort to improve this process, the Bureau of Forestry has introduced what is known as the "cup and gutter" system, by which more sap is saved and the tree less mutilated. Readers of the SCIENTIFIC AMERICAN are familiar with the efforts which have been made in this direction. The Bureau is also making a



A Turpentine Forest.



Turpentine and Rosin Ready for Railway Transportation.



Scene at a Turpentine Distillery.

of spirits and rosin. The latest statistics show the total value of naval stores sent to market in the United States to be about \$25,000,000, which will give an idea of the rapid expansion of the industry since its inception. At the present time about 30,000,000 gallons of spirits of turpentine are being distilled annually, and 3,500,000 barrels of rosin are sent to domestic and foreign markets. While the production of rosin has largely increased, the production of turpentine spirits has been decreasing steadily since the year 1900, when the total output was 38,500,000 gallons, showing an annual falling off of 22 per cent.

quota has been rapidly decreasing. The decline in South Carolina is principally due to the extensive lumbering operations which have stripped the State of the trees especially utilized in turpentine production.

The processes for securing turpentine have been so crude and wasteful that they also form one reason for the large decrease in the quantity of spirits distilled. The method employed in obtaining the turpentine is to make incisions in the trunk of the tree, gathering the sap in the same manner as the sap of the maple is secured. The incisions are frequently so long and deep that the vitality of the tree is greatly affected,

series of elaborate experiments in Florida with the view of ascertaining the effects of various kinds of incisions. These experiments, which were begun in 1905, are being made upon different forests, and already much valuable information has been obtained as to the kinds of incisions which are least injurious and at the same time will permit the maximum quantity of sap to be secured. A certain number of trees under inspection have been cut on one side of the trunk, another series on another side, while incisions have also been made of varying length and depth. As a result of these tests, it has been demonstrated that

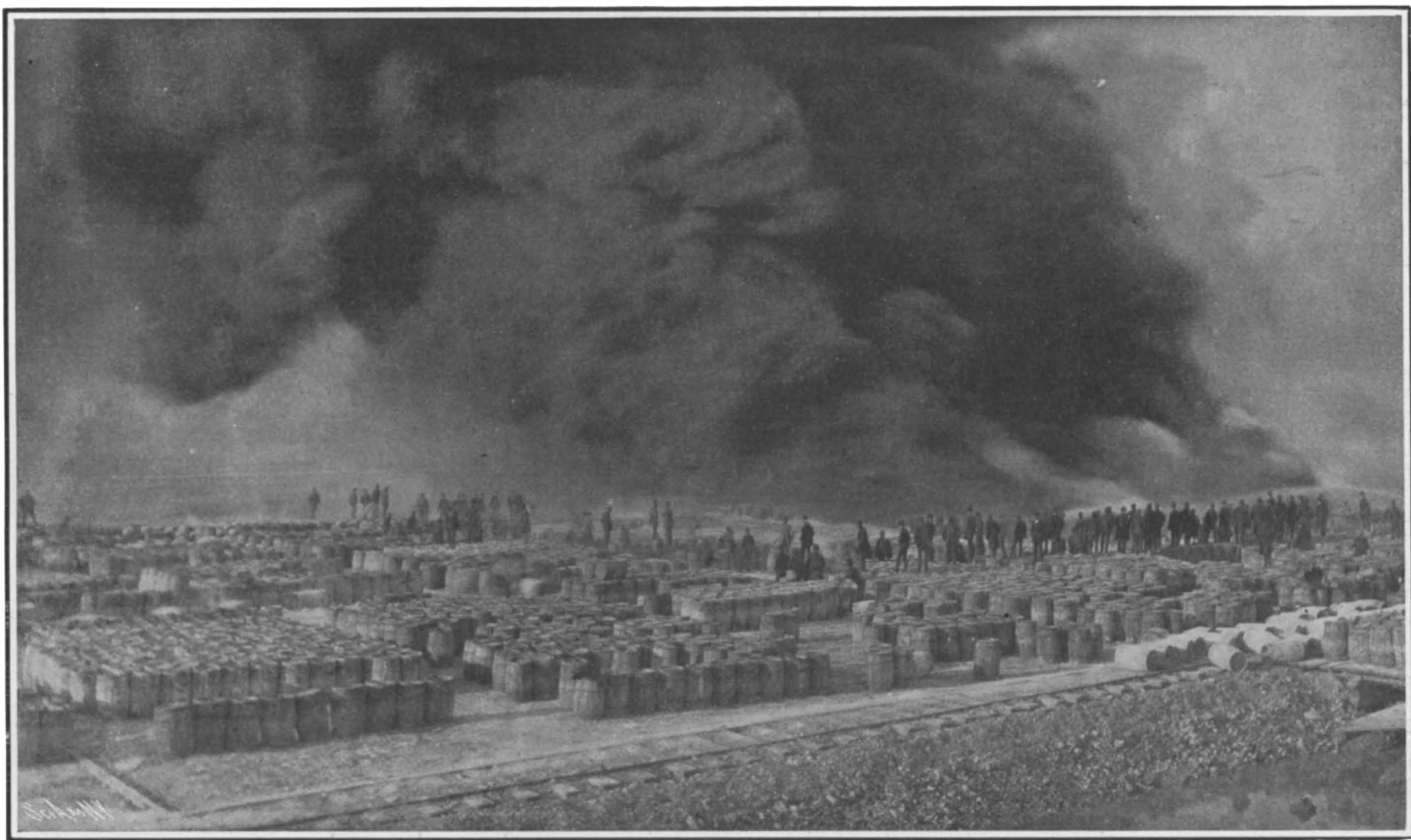

A Turpentine Conflagration in the Shipping Yard.
THE NAVAL STORES INDUSTRY.

usually the incisions are much longer and deeper than necessary to obtain the desired flow. Owners of turpentine forests, especially in Florida, have been closely observing the work referred to and already many of them have adopted the government process, while the cup and gutter system is being substituted on a large scale for the former methods.

The many beneficial properties of the sap of the yellow and other species of pine have greatly extended its use in recent years. At the present time about seventeen million gallons are utilized in varnishes and other compounds for covering material. Only in recent years has it been utilized extensively for soap, but now a number of the principal varieties of toilet soap are composed largely of some form of turpentine, while it may be called one of the necessary ingredients of some of the most popular patent medicines.

The advance in the price of pine lumber caused by the great demand for this material for building and other purposes has checked the turpentine industry to a certain extent. Up to ten years ago the comparatively low price obtained for the lumber induced the turpentine farmers to operate very extensively. Since the extraction of the sap from the tree not only hinders its growth, but injures it in other ways, much of the turpentine secured at present comes from the poorer grades of pine, such as the loblolly, and care is taken to save the larger trees of yellow pine from being tapped.

It is interesting to note that in this connection a process has apparently been discovered by which a large quantity of the waste material of pine sawmills can be utilized for the production of turpentine. If the experiments now under progress are successful, the industry may be revolutionized and the direct extraction of sap from trees abandoned. A lumbering company in Florida claims to have secured spirits of turpentine from sawdust and other waste at a maximum cost of thirty cents per gallon. The process of securing the liquid is as follows: First, the small pieces of pine are run through what the lumbermen call a "hog," which grinds the material so that it becomes practically sawdust. With the dust from the other machinery, this material is carried by means of an endless conveyor through the upper part of a still and dropped automatically into the series of retorts. As fast as each retort is filled, steam is applied in such quantities that the turpentine in the form of crude spirits is secured after an hour's treatment. The liquid then passes into a tank with condensed steam, the oil rising to the top. Conveyed to a second still, it then passes through a cooling worm to prevent it from evaporating, and is finally purified in vats especially designed for the purpose.

It is claimed that the quality of the turpentine is such that it can be utilized for practically all purposes for which the spirits obtained in the ordinary way are employed. Apparently the experiment is successful, for at this plant about 4,000 gallons are now produced monthly. Calculations which have been made of the quantity of material required for a gallon of turpentine show that the waste of 500 feet board measure of lumber is sufficient for this quantity. The manufacturers estimate that a cord of low grade pine sawmill dust will yield from five to ten gallons. Trials that have been made with fat light wood show that a cord of this material produced from fifteen to twenty gallons, while yellow pine stumps yield from twenty to thirty gallons to the cord. These figures are of more than passing interest, since they show very clearly that a large amount of stumpage which has been left in the pine forests as practically valueless can be utilized by the process we have described. While the present cost of manufacture is thirty cents a gallon, in all probability this expense can be considerably reduced by the introduction of more improved apparatus.

By far the most significant feature, however, is the fact that such an enormous quantity of waste material instead of being thrown away may become an exceedingly valuable asset and that every sawmill in the yellow pine district of the southern States of this country can have its auxiliary plant if it so chooses for manufacturing turpentine, just as so many cotton gins now have cotton seed oil and fertilizer mills in connection with them for treating what was also a few years ago considered a waste product.

More About the \$25,000 Mathematical Prize.

Some months ago we published a brief article in which we called attention to the prize of 100,000 marks (\$25,000) offered by the late Dr. Paul Wolfskehl of Darmstadt for a solution of the Fermat theorem. The prize is to be awarded by the Koenigliche Gesellschaft der Wissenschaften, of Goettingen, Germany. Since many readers of the SCIENTIFIC AMERICAN have expressed a desire to compete for the prize, we publish the following additional and more exhaustive information: Dr. Wolfskehl stated in his will that Fermat (see "Œuvres de Fermat," Paris, 1891, t. I, p. 291, observ. II) had formulated the law that the equation $x^{\lambda} + y^{\lambda} = z^{\lambda}$ cannot be solved for whole numbers for all exponents λ which are odd prime numbers. This theorem of Fermat's is to be proved either in the general way intended by Fermat or as an extension of Kummer's studies (Crelles Journal, 40, p. 130ff; Abh. der Akad. d. Wis. zu Berlin, 1857) for all possible exponents λ . Additional references are the following: Hilbert's "Theorie der algebraischen Zahlkoerper, Jahresbericht der deutschen Mathematiker-Vereinigung IV (1894-95), § 172-173, and Encyclopædie der mathematischen Wissenschaften, Bd. I, teil 2, "Arithmetik und Algebra" (1900-1904), I C 4b, p. 713.

The prize is to be awarded solely by the Koenigliche Gesellschaft der Wissenschaften of Goettingen. Manuscripts will not be accepted. The solutions must be printed either as monographs in periodicals or in pamphlet or book form, so that they can be purchased by any competitor. The Koenigliche Gesellschaft must be provided by the author with at least five such printed solutions. No solution will be considered which is printed in a language unfamiliar to the judges. Translations will be accepted for consideration. The rules do not state that the solutions must necessarily be written in German, and since most scientists are familiar with English we presume that printed Eng-

lish dissertations will be considered. Should the successful solution be the work of several collaborators or inspired by the work of several mathematicians, the Gesellschaft will divide the prize as it may deem advisable.

Coal Mining in China.

Interesting information about Chinese coal mines is contained in a report by the commercial *attaché* of the British embassy at Peking.

Little is known concerning the operation of the Manchurian mines granted by Japan to the South Manchurian railway company. The fact that no coal from these mines reaches Newchang indicates that their entire product is taken by the railway and local consumers. This coal is of excellent quality. A great deal of coal is mined by the Chinese in the province of Shansi. Coke made at one of these mines is used in the mint at Tientsin.

The three mines of the Chinese Engineering and Mining Company, northeast of Tientsin, produced nearly one million tons in 1906. These mines supply the Northern Railway and steamers and local consumers throughout northern China and part of Manchuria.

In 1905 a mine in Honan, in which a vein thirteen feet thick had been opened, was flooded so badly that it was necessary to send to England for additional pumping machinery. The coal of this vein proved too friable for use, but a vein of good quality ten feet thick was found at a lower level. In 1906, the Shantung Mining Company extracted 163,000 tons of coal from its Fang-tzu collieries. This company operates a briquette factory and one of the few coal washers in the Far East, with a capacity of 150 tons per hour.

In Kiangsi are hundreds of coal mines operated by the most primitive methods. Near the Hunan frontier, however, are mines operated under the direction of German mining engineers and connected with the Siang River by a railway 200 miles long. These mines were opened in 1908 for the purpose of supplying the forges and steel works of Hangang, which had been greatly developed under German management. Their output, which can be increased to 3,000 tons per day, is now 1,000 tons, most of which is converted into coke. The main shaft is 13 feet in diameter and 375 feet deep. Two veins are being worked, at depths of 160 and 320 feet. The main gallery is 3,000 feet long and the hauling is done by electric locomotives. It is estimated that this district of Ping-siang contains 300 million tons, of which the greater part can be extracted through

galleries and the remainder can be reached by a shaft 650 feet deep. Attached to these mines are 174 coke ovens, a briquette factory, a fire-brick factory, a foundry, coal washers, etc. From the railway terminus at Chuchoy the coal and coke are conveyed to Hangang in towboats and junks. The Ping-siang Coal Mining Company has achieved a brilliant success in the face of enormous difficulties, and it deserves great credit for the introduction of European methods into a primitive land.

The following table of the annual production of coal in China is condensed from a table compiled in 1906 by Prof. Drake, of the Imperial University of Tien-tsin.

Province.	Annual Prod. in tons.		Total.
	Mines owned by Europeans.	Mines owned by Chinese.	
Chili	1,200,000	1,000,000	2,200,000
Shansi	—	3,000,000	3,000,000
Shantung	300,000	500,000	800,000
Honan	100,000	700,000	800,000
Other Prov.	230,000	1,860,000	2,090,000
Total	1,830,000	7,060,000	8,890,000

Lower Postal Rates to England.

October first witnessed a heavy increase in mail for Great Britain and Ireland, the rate changing from 5 cents to 2 cents an ounce at midnight. It is too early as yet to tell what the volume of increase will be, as there are always large accumulations of mail matter held back when there is any change in a postal rate. A big annual saving will be effected in thousands of concerns who do a large foreign business. It is hoped that other countries will fall in line, and make similar arrangements.



Turpentine on the Wharf Ready for Shipment.

THE NAVAL STORES INDUSTRY.

lish dissertations will be considered. Should the successful solution be the work of several collaborators or inspired by the work of several mathematicians, the Gesellschaft will divide the prize as it may deem advisable.

The prize will be awarded not sooner than two years after the publication of the successful solution by the Gesellschaft. This period of two years is stipulated in order that the mathematicians of the world may have an opportunity of verifying the correctness of the solution which has won the prize.

If the prize is not awarded by September 13, 2007, no further claim will be considered.

Since the solutions must be submitted in pamphlet or periodical form, the Editor of the SCIENTIFIC AMERICAN SUPPLEMENT has decided to open his columns to those contestants whose solutions have not already been printed and who may wish to submit copies of the SUPPLEMENT containing their solutions to the Gesellschaft. His space is so limited, however, that he cannot promise to publish all solutions sent to him.

Sugar as a Disinfectant.

In many parts of Europe it is customary among the people to burn sugar in sick rooms, a practice which is considered by physicians as an innocent superstition, neither beneficial nor harmful. Prof. Trilbert, of the Pasteur Institute at Paris, has, however, demonstrated recently that burning sugar develops formic acetylene-hydrogen, one of the most powerful anti-septic gases known. Five grammes of sugar (77.16 grains) were burned under a glass bell holding 10 quarts. After the vapor had cooled bacilli of typhus, tuberculosis, cholera, smallpox, etc., were placed in the bell in open glass tubes and within half an hour all the microbes were dead. If sugar is burnt in a closed vessel containing putrified meat or the contents of



The Editor of Handy Man's Workshop will be glad to receive any hints for this department and pay for them if available.

THE EVOLUTION OF THE DOVETAILED BOX.
BY CHARLES CHRISTADORO.

The accompanying engraving illustrates a self-locking double dovetail which cannot be pulled off in either

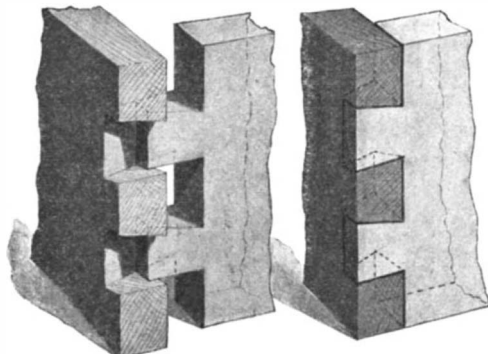

THE SELF-LOCKING DOVETAIL JOINT.

direction. On one of the pieces the tenons are chamfered at the inside while the grooves on the other piece are formed with a correspondingly chamfered inner wall. The corners are joined not by forcing one side piece at right angles to the other, but by placing the side pieces within the ends of the end pieces and then bringing the corner joints into place by moving the side pieces diagonally outward. A box thus constructed cannot pull apart without first crushing in the sides, as this is the only direction in which the tenons of the side pieces may be moved out of engagement with those of the end pieces.

CUTTING WOOD WITH PAPER.

A tall candle bullet can be fired through a board. A straw driven by a cyclone will penetrate a tree. A stream of water, under high pressure, will tear the skin off a man's hand. A copper disk rotating slowly can be cut by a steel cutting tool; but if rotated at high speed it will turn about and cut the tool. These facts suggested the following experiment on the cutting ability of paper. Everyone knows that the hand can be badly cut with paper; but the experiment was undertaken to discover whether hard substances, such as wood, could be cut with paper.

A page of the SCIENTIFIC AMERICAN was trimmed to the form of a disk, 10 or 11 inches in diameter, and a wooden spool was glued to the paper at its center. An electric fan was dismantled of its fan and guard and the spool was bored out to fit snugly on the armature shaft. A wood screw with its point blunted was threaded through the spool and against the shaft to fix the disk securely thereon. Then the current was turned on and a pencil was held lightly against the edge of the spinning paper. Although the paper bit into the wood the centrifugal force was not sufficient to hold the paper rigid, and instead of making a clean cut it scratched the wood as if by a file. The fan was making about 2,000 revolutions per minute, but the speed should have been doubled for so thin a paper. Better results were obtained by pasting the paper on a disk of cardboard of smaller diameter, so that the edge of the paper projected half an inch over the periphery of the cardboard. With this a clean cut was made into the wood of the pencil.

But the best cutter was made out of a sheet of three-ply Bristol board, the kind on which drawings for the Patent Office are commonly prepared. With this stiff paper the pencil was cut into very quickly, and the cut was exceedingly fine and clean. When the lead of the pencil was reached, the progress of the cutter was much slower because the graphite act-



CUTTING A PENCIL WITH A DISK OF BRISTOL BOARD.

ed as a lubricant. Neither the paper nor the Bristol board showed any material wear with use. The photograph shows the Bristol-board cutter making a cut, while in the foreground is a pencil which has been cut in two by the paper.

A UNIVERSAL JOINT OF SIMPLE DESIGN.

Most universal joints on the market have at least a dozen different parts. One which has a big sale at present has no fewer than seventeen distinct parts, not including the shafts or feather keys for adjustment.

The universal joint illustrated in Fig. 1, which was designed on account of the high price asked by some of the standard makers, and which has given every satisfaction for the rough purpose for which it was intended, has but two jaws, two pins, and one washer

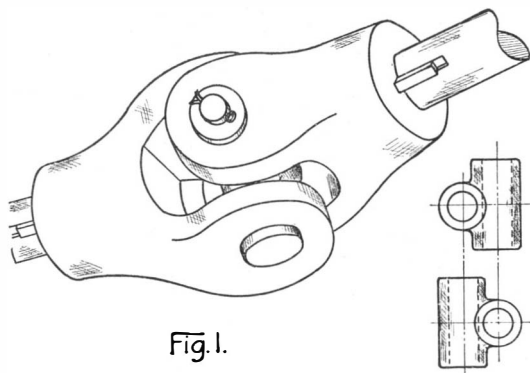

Fig. 1.

A TWO-PIN UNIVERSAL JOINT.

or distance piece, shown in plan and elevation on the right.

It will be noticed, however, that this design is imperfect, in that the two pins, which cross each other at right angles, are not in the same plane. To improve upon this, and also to reduce still more the number of parts, the writer designed a joint as shown in Fig. 2. A model was made and so far it seemed successful.

The model was shown to a well-known engineer, who, while commending the idea of reducing the number

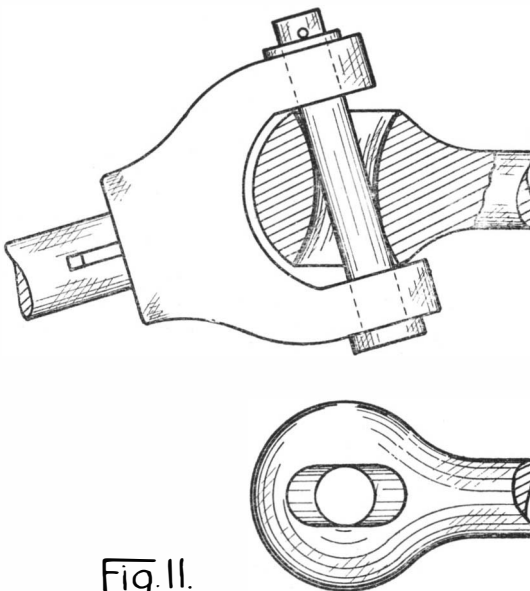

Fig. 11.

UNIVERSAL JOINT WITH ROUND PIN AND SLOT.

of parts, pointed out the bad features of the design, in having a round pin wearing on a flat surface.

The writer tried to rectify this by having a square slotted hole instead of a round one, and a square shaft or pin with a round hole through, for the main pin. This he found would require so much fitting that the cost would bring it up to the standard price.

In Fig. 3 a design is shown which has not been put to a practical test, but is open to criticism. The slotted

round hole shown in design, Fig. 2, has been changed to a slotted square hole.

One end of the pin in diameter is the same as the diagonal of the square body. The other end of the pin is the same in diameter as the side of the square.

There is no reason, however, why the square body of the pin could not be continued to the end, and fitted into a collar or bushing, the inside hole of which being

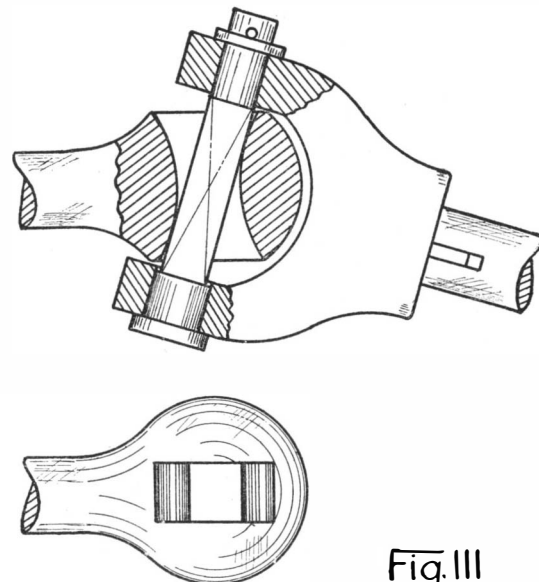

Fig. III

THE SQUARE PIN UNIVERSAL JOINT.

a square tight fit, and the outside a loose round fit, to enable it to revolve, as the other end of the pin.

HOW TO OBTAIN FRESH WATER FROM SEA WATER.

A common method of getting salt from sea water is to place the liquid in shallow vats, and expose it to the sun until the water is evaporated. Someone has suggested that the same process of separation be used to get fresh water out of the sea water. Cover the vat with a pane of glass which is tilted slightly. The radiant heat of the sun passing through the glass will evaporate the water, and the vapor condensing on the under side of the glass will run down the inclined surface and drip into a trough. A receptacle at one side will catch the fresh water that flows from the trough.

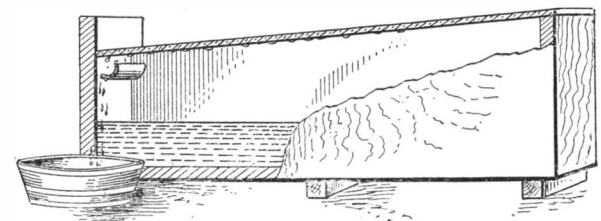

A SIMPLE APPARATUS FOR DISTILLING FRESH WATER FROM SEA WATER.

The condensation may be expedited by pouring water over the glass. The glass will thus be chilled without interfering with the passage of the sun's rays into the vat.

Waterproof Matches.

BY JAMES BAILEY.

Perhaps some of your readers would be interested to know that I have found a simple, inexpensive way to waterproof matches. Into some melted paraffine (care being taken that it was as cool as possible) I dipped a few ordinary parlor matches. After withdrawing them and allowing them to cool it was found that they scratched almost as easily as before being coated with the wax. Several were held under water for six or seven hours and all of them lighted as easily as before immersion. When the match is scratched the paraffine is first rubbed off and the match lights in the usual way.

Matches treated as above would be very useful on camping or canoeing trips, as they do not absorb moisture. Since more rubbing is required to light them than the ordinary match, it would be practically impossible to set them on fire by accidentally dropping.

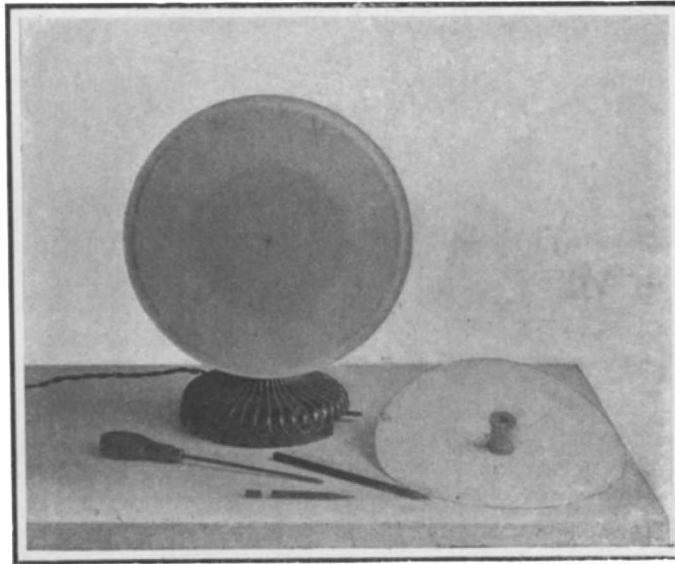

THE SCIENTIFIC AMERICAN AS A CUTTING TOOL.

RECENTLY PATENTED INVENTIONS. The inventions described in this Department were Patented through the Scientific American Patent Agency.

Of Interest to Farmers.

WEED BURNER.—A. ITEN, Mountainview, Hawaii Ty. The apparatus is adapted to be used between rows of growing crops to destroy weeds by burning without injuring the crops. A number of liquid fuel burners are used whose flames are directed downwardly to burn the weeds together with any insects thereon, and to destroy any obnoxious animal or vegetable life among the crops.

Of General Interest.

MOUNTING FOR PRECIOUS STONES.—W. R. ELLIOTT, New York, N. Y. The invention consists in so constructing a finger ring or scarf pin that it will be in two hinged sections which are locked together by the act of applying the stone in the mount, thus enabling the ring to be fitted to the finger at a point below the knuckle over which it could not otherwise be passed.

MANUFACTURE OF SULPHURIC ACID AND SODIUM SULPHATE.—U. F. BENKER, 129 Rue Martre, Clichy, Seine, France. This is a process of making free sulphuric acid and neutral sulphate of soda by the decomposition of bisulphate of soda, consisting in heating a mixture of bisulphate of soda and of silica in substantially equal proportions, thus preventing the fusion of the bisulphate.

GLASS HOLDER.—J. W. BRICKER, Wilmerding, Pa. This holder is adapted particularly for use in dispensing soda water. Its principal advantage lies in the fact that it has substantially no corners or crevices for the collection of dirt so that it may easily be cleaned and kept in a sanitary condition.

BUILT-UP POST.—C. F. STEIBER, New York, N. Y. The object of the invention is to produce a post which is built up of a number of pieces set together, and it relates especially to the construction of the base, the capital, and the collar which connects the upper part of the post with the lower section. The form of these parts is such as to facilitate their being stamped from sheet metal.

FRAME.—L. SBORIGI, New York, N. Y. The frame is made up of sheet metal members which are bent upon themselves to form side walls and bent further upon themselves to form inner walls parallel with the side walls and separated therefrom by slots. The side members are connected at the corners by angle members which are fitted in the said slots of the adjacent side members.

Hardware.

WRENCH.—A. L. SHAW, Corinne, Utah. The invention provides a simple wrench by means of which vehicle wheels may be removed easily and expeditiously and which will prevent marring or other injury of the wheel. The device is provided with two pairs of jaws of which one pair may be clamped upon the axle nut, and the other pair on the vehicle wheel hub.

DOOR FASTENER.—F. E. RICHARDSON, Manchester, Iowa. The fastener is arranged to act automatically when the door is closed, to hold the same resiliently in closed position. A further object of the invention is to provide a fastener consisting of a catch and a retainer for the catch, the latter resiliently engaging the retainer and being adjustable so that its resistance to disengagement from the retainer can be regulated.

Pertaining to Recreation.

CAR FOR OBSERVATION WHEELS.—A. F. BIAVATI, Freeport, N. Y. The cars are self-balancing so that they will remain in an upright position as the observation wheel revolves. This is accomplished by making the cars in the form of drums with heavy weights at the lower ends and mounting them on rollers in annular tracks in the wheel.

Pertaining to Vehicles.

VEHICLE WHEEL.—I. C. SCUDDER, New York, N. Y. This construction is arranged to permit a tire to be attached to or detached from a wheel while inflated. A detachable rim is provided which carries the inflated tire and this rim may be quickly and easily attached without requiring the use of special tools.

Designs.

DESIGN FOR A FRONT MEMBER FOR RACKS OR DRAWERS.—D'A. B. PLUNKETT, New York, N. Y. The design is in the form of a panel, provided with a handle at the center and a series of bosses are formed on the panel with projecting cubes marked with stars.

DESIGN FOR A SUPPORTING BRACKET.—J. KISER, Katalla, Dist. of Alaska. The bracket has the general form of an inverted A and a figure standing on the cross bar of the A holds a slanting bar which extends upward and supports the outer end of the upper cross bar of the bracket.

NOTE.—Copies of any of these patents will be furnished by Munn & Co. for ten cents each. Please state the name of the patentee, title of the invention, and date of this paper.

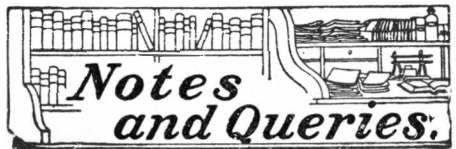

Full hints to correspondents were printed at the head of this column in the issue of August 5th, or will be sent by mail on request.

(10883) E. E. B. writes: Under your heading, p. 139, I read that the "Lusitania" beats all records. Do I understand that she has won her record back from the "Indomitable," which you spoke of in your paper a few weeks ago? A. The "Lusitania" holds the Atlantic record for any type of ship with an average speed of 25.05 knots.

(10884) A. P. McK. says: In your issue of September 12th you call the attention of the public to the fact that there is a growing demand for a noiseless rail joint. Will you kindly answer in your Notes and Queries column if it is a fact that when trains are traveling, say all in east or west direction, that the rails have a tendency to creep in opposite direction to which the train is moving, or do they creep in the same direction that the train is moving, or do they creep at all, for any other reason than contraction or expansion? A. Rails tend to creep in the direction of the traffic. The amount of movement depends upon certain local conditions which are not as yet well understood.

(10885) F. H. says: Please advise me if the word *cheeses* is correct; also state in what way it would be used if correct. Give several different ways. A. The plural of cheese is cheeses. The Century Dictionary has this: "Soft cheeses, such as cream cheese, bath, and Yorkshire cheese, do not keep long." If we should buy five we should not say five cheese but five cheeses. This usage satisfies us.

(10886) A. H. W. says: It is stated that the first suspension bridge ever in existence was in the city of Budapest, and that the Brooklyn bridge was modeled after same. That Budapest had the first subway, and the same was used as a model for the New York Subway. That Budapest has a telegraphic newspaper, viz., that telegraphic messages are at once connected by the instrument with the one bringing the message, printed in newspaper form. A. It would be difficult to determine which was the first suspension bridge; for it is a fact that from time immemorial, in some parts of Asia, suspension bridges have been formed of rope fiber. Those bridges are across comparatively short streams and are very crude, it is true, but they contain the principle. The Brooklyn bridge is by no means the first metal suspension bridge. Early in the nineteenth century a chain suspension bridge was constructed across the Menai Straits in England, which had a span of 580 feet; and the bridge over the river Avon at Clifton, England, also a chain bridge which originally spanned the Thames, are probably as old. Budapest had the first subway, and many of its good points are embodied in our present New York Subway, particularly the kiosks at the top of the stations. For a long time Budapest has had a telegraphic newspaper and also telephonic concerts. The inhabitants of Budapest are very advanced.

(10887) B. F. M. asks for information concerning sunstroke. A. Sunstroke is caused by excessive heat, and especially if the weather is muggy. It is more apt to occur on the second, third, or fourth of a series of hot days than on the first. Loss of sleep, worry, excitement, close sleeping rooms, debility, abuse of stimulants, predispose to it. It is more apt to attack those working in the sun, and especially between the hours of eleven o'clock in the morning and four o'clock in the afternoon. On hot days wear thin clothing. Have as cool sleeping rooms as possible. Avoid loss of sleep and all unnecessary fatigue. If working indoors and where there is artificial heat (laundries, etc.), see that the room is well ventilated. If working in the sun, wear a straw light hat (not black, as it absorbs the heat), etc., and put inside of it, on the head, a wet cloth or a large green leaf; frequently lift the hat from the head and see that the cloth is wet. Do not check perspiration; but drink what water you need to keep it up, as perspiration prevents the body from being overheated. Have, whenever possible, an additional shade, as a thin umbrella when walking, a canvas or board cover when working in the sun. If a feeling of fatigue, dizziness, headache, or exhaustion occurs, cease work immediately, lie down in a shady and cool place, apply cold cloths to and pour cold water over head and neck. If any one is overcome by the heat, send immediately for the nearest good physician. While waiting for the physician, give the person cool drinks of water or cold black tea, or cold coffee, if able to swallow. If the skin is hot and dry, sponge with or pour cold water over the body and limbs, and apply to the head pounded ice wrapped in a towel or other cloth. If there is no ice at hand, keep a cold cloth on the head and pour cold water on it, as well as on the body. If the person is pale, very faint, and pulse feeble, let him inhale ammonia for a few seconds, or give him a teaspoonful of aromatic spirits of ammonia in two tablespoonfuls of water with a little sugar.

NEW BOOKS, ETC.

THE AIR AND VENTILATION OF SUBWAYS. By George A. Soper, Ph.D. New York: John Wiley & Sons, 1908. 12mo.; pp. 244. Price, \$2.50.

This volume is the outcome of studies carried on for two and one-half years for the Board of Rapid Transit Railroad Commissioners for the city of New York and, after that Board went out of existence, for the Interborough Rapid Transit Company, to whom the first New York subway is leased. The work was begun in the summer of 1905 and concluded in 1907. The original data covering about 2,000 pages have never been published, although reports summarizing many of the facts have appeared in the official transactions of the Rapid Transit Commissioners. It has seemed desirable to preface the description of the investigation by a few facts concerning the scientific groundwork upon which the solution of problems of ventilation should be based, and to this end the composition of good and bad air, some mechanical principles of the atmosphere and other matters have been included. The object throughout has been to make available in convenient form an account of the essential features of the investigation, in the hope that the information may be of service to persons not necessarily trained in sanitary science, but interested in knowing what good and bad air consists in and how to deal with it in subways and other inclosed spaces.

CYCLOPEDIA OF CIVIL ENGINEERING. Editor-in-Chief Prof. F. E. Turneaure, C.E., Dr. Eng., Dean of the College of Engineering, University of Wisconsin. Eight volumes. Chicago: American School of Correspondence, 1908. 8vo.; pp. 3200, 3,000 illustrations. Price, \$24.

This is a general reference work, and the first of its kind covering the entire field of modern engineering practice. It is particularly suited for the civil, structural, railroad, sanitary, irrigation, hydraulic, and hydro-electric engineer. The different departments have been prepared by a staff of practical experts of the highest professional standing in their particular lines of work. For this reason, the matter is up-to-date and representative of the best engineering methods, and should be of great value to the practical engineer, although primarily intended for the use of students. The work is prepared in the characteristic style of the American School of Correspondence, the subjects being taken up in very simple and clear language, so that they can be thoroughly understood by the student who is studying at home and hence is unable to clear up difficult points by directly questioning his instructor. For this reason abstruse formulæ are avoided, and the text is very fully illustrated with diagrams and half-tone engravings. Among the staff who have assisted Prof. Turneaure in the preparation of this work are such men as Prof. A. E. Phillips of the Armour Institute of Technology, author of "Plane Surveying and Irrigation Engineering," and joint author of "Highway Construction"; Walter Loring Webb, author of "Masonry and Reinforced Concrete," "Railroad Engineering," and "Plotting and Topography"; H. P. Gillette, joint author of "Cost-Analysis Engineering"; E. A. Tucker, author of "Steel Construction"; Prof. F. O. Dufour of the University of Illinois, author of "Bridge Engineering and Roof Trusses"; Prof. A. Black of Columbia University, author of "Water-Power Development"; Prof. C. E. Morrison of Columbia University, author of "River and Harbor Improvement"; Prof. A. Marston of Iowa State College, author of "Sewers and Drains"; and Charles B. Ball, chief sanitary inspector of the city of Chicago, joint author of "Plumbing and House Sanitation." Other important sections are those on Statics, Strength of Materials, Mechanical Drawing, and Practical Problems in Construction in Steel and Concrete.

POLK'S LUMBER DIRECTORY OF THE UNITED STATES FOR 1907-8. Detroit, Mich.: R. L. Polk & Co., 1907. 8vo.; pp. 1614. Price, \$10.

This immensely valuable trade directory is very comprehensive, much more so than its title would lead one to suppose. It comprises lists of manufacturers of agricultural implements, boat builders, box manufacturers, car builders, carriage and wagon builders, chair manufacturers, cooperage stock, furniture manufacturers, hub and spoke manufacturers, logging railroads, lumber and lumber-mill machinery of all descriptions, piano and organ manufacturers, planing mills, saw mills, ties, posts and poles, veneer manufacturers, woodenware manufacturers, and a host of other allied interests together with laws affecting the lumber interests. This is the third revised edition. We have used the book, and have found it to be reliable.

THE FUNDAMENTAL CONCEPTIONS OF CHEMISTRY. By Dr. S. M. Jørgensen, Professor of Chemistry at the University of Copenhagen. Translated by M. P. Appleby, B.A. London: Society for Promoting Christian Knowledge; Brighton. New York: E. S. Gorman, 1908. 32mo.; cloth; 175 pages; illustrated.

Prof. Jørgensen's book belongs to a series of manuals of Elementary Science, and it discusses the more important of the theories forming the basis of modern chemistry. In its divisions into the weight and volume relations of chemi-

cal compounds, the atmosphere, acids, brass, salts, aqueous solutions, oxidation, and reduction and chemical action, the advance and collapse of theories of chemistry are treated in a scientific, historic and biographical manner. The work is intended to accustom a student to the methods of chemical thinking, and in the process he is given the aid of the necessary figures and experiments.

INDEX OF INVENTIONS

For which Letters Patent of the United States were Issued for the Week Ending

September 29, 1908,

AND EACH BEARING THAT DATE

[See note at end of list about copies of these patents.]

Table listing various inventions and their patent numbers, including items like 'Adding machine, H. L. Fisher', 'Bag closing mechanism, J. Rogers', 'Belt and belt fastener, K. Mastale', etc.

Table of classified advertisements with columns for advertiser name and price. Includes items like Crupper, L. S. Ellis, Cultivating implement, F. H. Weaver, etc.

Classified Advertisements

Advertising in this column is 75 cents a line. No less than four nor more than ten lines accepted. Count seven words to the line. All orders must be accompanied by a remittance. Further information sent on request.

READ THIS COLUMN CAREFULLY.—You will find inquiries for certain classes of articles numbered in consecutive order. If you manufacture these goods write us at once and we will send you the name and address of the party desiring the information. There is no charge for this service. In every case it is necessary to give the number of the inquiry. Where manufacturers do not respond promptly the inquiry may be repeated.

MUNN & CO.

BUSINESS OPPORTUNITIES.

A CORPORATION of highest standing having large well equipped factory and selling organization and ample capital desires to manufacture and market mechanical inventions of unquestioned merit. Correspondence solicited. Address K. A., Box 773, N. Y. City.

Inquiry No. 8611.—Wanted to buy springs for light power purposes. \$100 FIRST MORTGAGE 6 Per Cent. Gold Bonds. \$90 cash or \$91.50 in ten monthly payments. Lewis N. Rosenbaum Co., Inc., Investment Bonds, Capital and Surplus \$138,468.03. Washington Bldg., Seattle, Wash.

Inquiry No. 8650.—Wanted to buy file cutting machinery. BUSINESS BOOK FREE. Tells how you can secure the actual working plans, the money-making systems, schemes and short cuts of 112 great, big business men—to increase your salary—to boost your profits. Book is free. System, Dept. 177, 151-153 Wabash Ave., Chicago.

PATENTS FOR SALE.

FOR SALE.—A carousal, patent No. 894,386, issued July 28, 1908. Owner was killed in accident few days after it was allowed. Will sell reasonable. Address James Petracek, Oberlin, Kans.

Inquiry No. 8667.—Wanted to buy needle, pin and pen machinery. A MONEY MAKING PATENT FOR SALE.—Portable coal bin for kitchen and parlor. For full information address A. H. Koch, 228 W. 11st St., New York.

Inquiry No. 8685.—Wanted to buy 1 1/2 to 2-inch No. 13 to 18 tempered spring steel. FOR SALE OR MANUFACTURE.—Patent No. 896,515, issued August 18, 1908, for artificial bearing for cars, automobiles, heavy wagons, machinery. Address A. B. Chapman, 607 Marion St., Tampa, Florida.

Inquiry No. 8687.—Wanted to buy motor plows. FOREIGN PATENTS for meritorious and valuable inventions (especially British) negotiated upon a contingent basis. Absolutely no fees accepted. Refer ences given and required. L. Henry, 141 Broadway, New York.

Inquiry No. 8699.—Wanted to buy two-stranded soldered wire for heddles. FOR SALE.—Safest, best and easiest draft manure spreader. Works without an apron. Address A. A. Poken, Raymond, South Dakota.

Inquiry No. 8701.—Wanted to buy sol engines. FOR SALE.—Patent 887,125 for apparatus for instantaneous killing, with safety, all the rats in a burrow, including sucklings, at nominal cost. Demand must be unlimited. Address Henry Reese, 1522 Madison Ave., Baltimore, Md.

Inquiry No. 8721.—Wanted unwelded tubing that is used for structural work. PATENT No. 884,167.—A new one. Nothing like it patented. Worth investigating. Address R. L. Kennon, Jr., Box 887, Birmingham, Ala.

Inquiry No. 8735.—For parties making a still for the purpose of extracting alcohol from saw-dust. FOR SALE.—Patent No. 895,551 "Vehicle Cleaning Device." All tools for manufacture, trade quite well established. Address E. P. Gaylord, Rochester, N. Y.

Inquiry No. 8736.—For manufacturers of machinery for making matches, also machinery for making purses and hand bags.

HELP WANTED.

WANTED.—Competent foreman for modern shot-making plant having capacity of 15,000 to 20,000 tons a year. In writing, state experience and give references. Winchester Repeating Arms Co., New Haven, Conn.

Inquiry No. 8737.—For manufacturers of machinery for making tooth-brushes, shaving brushes, galvanized water buckets, locks, nibs and holders.

AGENTS WANTED.

REINHOLD ALUMINUM SOLDER sells at sight. Absolutely new article. Splendid seller. Send 50 cents for sample and instructions. Easy to get busy with this. E. M. & R. Co., Sunday Call, Newark, N. J.

Inquiry No. 8742.—For manufacturers of water still, also of thermometer tubing.

SITUATIONS WANTED.

WANTED.—Situation with some honorable structural engineers, by honest young man with ingenious ability. Address James Ashmead, Tiocondroga, N. Y.

Inquiry No. 8746.—For dealers in paper and cardboard making machines.

AUTOMOBILES.

HOW ABOUT YOUR GASOLINE MOTOR? Does it run smoothly? Send for 36-page text-book "Carburetors and Engine Troubles." Breeze Carburetors, 242 Halsey Street, Newark, N. J.

Inquiry No. 8748.—Wanted to buy polished or lacquered brass in sheets 29 gauge, quarter hard in temper.

TYPEWRITERS.

YOUR CHOICE of a machine from \$10 up and Franklyn Hammond, Remington, Oliver, Monarch, L. C. Smith, Underwood, Smith Premier, Bickenderfer, Fox. Agents wanted. Standard Typewriter Ex., 23 Park Row, N. Y.

Inquiry No. 8749.—For makers of very large springs, used for running machinery.

REAL ESTATE.

EXCELLENT LAND for factory sites for sale freehold or on lease at Stamford, Lincolnshire, England. Good railway facilities on Great Northern Railway sidings, water drainage and electric power available. Apply Burleigh Estate Office, Stamford, England.

Inquiry No. 8769.—For manufacturers of an appliance to attach to the old style razor blade to make same a safety razor.

PHOTOGRAPHY.

AMERICAN PHOTOGRAPHY.—A monthly magazine containing up-to-date information about photographic processes, formulas and new apparatus. Each number is filled with numerous illustrations of recent pictorial photographs. Valuable to the professional and beginner. 15 cents monthly, \$1.50 per year. Three specimen copies for 25 cents. Am. Photographic Publishing Co., No. 6 Beacon Street, Boston, Mass.

LISTS OF MANUFACTURERS.

COMPLETE LISTS of manufacturers in all lines supplied at short notice at moderate rates. Small and special lists compiled to order at various prices. Estimates should be obtained in advance. Address Munn & Co., List Department, Box 773, New York.

A LIST OF 1,500 mining and consulting engineers on cards. A very valuable list for circularizing, etc. Price \$15.00. Address Munn & Co., List Department, Box 773, New York.

Inquiry No. 8770.—For parties who make short link twist chains, links from 1/4 inch up.

Inquiry No. 8771.—Wanted to buy tune sheets for Criterion music boxes.

Inquiry No. 8774.—For machinery for making bags from sisal hemp.

Inquiry No. 8775.—Wanted to buy stock novelty or jewelry catalogues.

Inquiry No. 8778.—For manufacturers of reapers, binders and mowers.

Inquiry No. 8779.—For parties manufacturing gas, gasoline, steam engines and boilers; also packing and mineral wool, steam supplies, iron and lead pipe, power transmission machinery and steam fitters' tools.

Inquiry No. 8780.—For parties who make gasoline stoves.

Inquiry No. 8783.—For manufacturers of small drummer's traps as whistles, rattles, rooster crows, etc.

Inquiry No. 8784.—For manufacturers of alcohol burners for lights and stoves.

Inquiry No. 8786.—For parties to manufacture glass balls blown about 1 1/2 inch in diameter with a 1/4 inch hole through the center, should hold about 200 pounds to the square inch of steam pressure.

Inquiry No. 8787.—For parties who manufacture cat-gut.

Inquiry No. 8790.—For the manufacturer of "Brooks improved hand pump."

Inquiry No. 8792.—For a firm that manufactures glass holders made of glass.

Inquiry No. 8794.—For manufacturers of the "Ideal Dust Pan."

Inquiry No. 8795.—For a mechanical device for catching or destroying flies, mosquitos, etc.; also traps for catching snakes.

Inquiry No. 8796.—For concerns manufacturing stills adapted to the manufacture of denatured alcohol.

Inquiry No. 8797.—For manufacturers of fiber.

Inquiry No. 8798.—For manufacturers of micro lenses used in small articles such as pencils, charms, etc.

Inquiry No. 8799.—Wanted to buy new or second-hand box nailing machine for small packing cases.

Inquiry No. 8800.—Wanted complete data in regard to pegamoid.

Inquiry No. 8802.—Wanted to buy machinery for cutting and polishing oilstones, whetstones or grindstones.

Inquiry No. 8803.—For manufacturers of files, screws, druggists' supplies, hardware in general, and agricultural machinery.

Inquiry No. 8804.—For parties dealing in windmills, wood split pulleys, wheelbarrows, cutlery and picks.

Inquiry No. 8805.—Wanted to buy outfits and supplies for brazing.

Inquiry No. 8806.—For manufacturers of drawing materials.

Inquiry No. 8807.—For dealers in second-hand cotton machinery.

Inquiry No. 8810.—For makers or importers of porous water bottles or jars to cool drinking water by evaporation.

Inquiry No. 8811.—Wanted to buy electric tattooing needles, inks and stencils.

Inquiry No. 8812.—Wanted to buy outfits for manufacturing fuel briquettes from sawdust.

Inquiry No. 8813.—For manufacturer of the "Steele" mixer for mixing food products, etc.

Inquiry No. 8814.—Wanted to buy hand lever air pumps, 100 lbs. pressure.

Inquiry No. 8815.—Wanted to buy carriage and wagon hardware coal, iron and steel.

Inquiry No. 8817.—For a firm that forms small articles of wire, also a firm to make wooden rings about 3 or 4 inches in diameter.

Inquiry No. 8818.—Wanted to buy specialties in large quantities.

Inquiry No. 8819.—For manufacturers of Excelsior Welding Compound.

Inquiry No. 8820.—Wanted to buy pressed fiber boards 1 foot wide and from 1-16 to 1/4 inch thick.

Inquiry No. 8821.—Wanted to buy machinery for making a rough composition board, something like a straw board.

Inquiry No. 8822.—For manufacturers of dredging machinery to be operated by gas engine.

Inquiry No. 8823.—For manufacturers of crepe paper and paper novelties.

Inquiry No. 8824.—For a firm to design and build an automatic machine for making finger shields.

Inquiry No. 8825.—For manufacturers of a new device to split wood.

Inquiry No. 8826.—Wanted to buy small fuel compression machines both manual and engine power.

Inquiry No. 8827.—For manufacturers of annealed glass.

Inquiry No. 8828.—Wanted to buy thin, highly tempered steel for safety razors.

Inquiry No. 8829.—Wanted to buy machinery for making pins, hair pins, hooks and eyes.

Inquiry No. 8830.—Wanted to buy machinery for making brushes and baskets.

Table of classified advertisements with columns for advertiser name and price. Includes items like Kiln, Croft & Reif, Kinetoscope, G. A. Knaak, Lacing fastening, W. V. Munsell, etc.

The Highest Efficiency

combined with durability and simplicity of operation, characterizes all our Woodworking Machinery for the use of carpenters, builders, cabinet-makers and woodworkers generally.

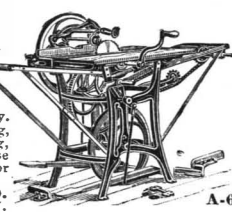

Engine and Foot Lathes

MACHINE SHOP OUTFITS, TOOLS AND SUPPLIES. BEST MATERIALS. BEST WORKMANSHIP. CATALOGUE FREE

SPECIAL TO AUTOMOBILISTS:

Bosh Magneto Plugs only \$1.25 each. Guaranteed in every respect. We sell automobile supplies cheaper than any supply house in the United States.

CONSUMERS AUTO SUPPLY CO. 1252-1254 Wabash Avenue, Chicago, Ills.

The Perfection Wrench

Newest wrench on the market. Best "all-round" tool ever made. All steel—great strength. Instantly adjusted. Easily and quickly operated.

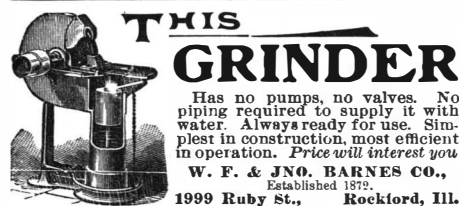

THIS GRINDER

Has no pumps, no valves. No piping required to supply it with water. Always ready for use.

AUTOMOBILES (new), high grade, can be bought from us positively cheaper than manufacturers' prices. We buy for spot cash; wonderful what ready money will do.

WELL DRILLING Machines

Over 70 sizes and styles, for drilling either deep or shallow wells in any kind of soil or rock.

Concrete, Reinforced Concrete AND Concrete Building Blocks

Scientific American Supplement 1543 contains an article on Concrete, by Brysson Cunningham. The article clearly describes the proper composition and mixture of concrete and gives results of elaborate tests.

Table listing various mechanical parts and their prices, including items like Roasting furnace, Rock drilling machines, Rolling mills, Roofing material joint, etc.

Advertisement for Stevens Rifles, Shotguns, and Pistols. Features an illustration of a man in a hat aiming a rifle. Text includes 'NEW DOUBLE BARREL SHOTGUNS' and 'fitted with Stevens Compressed Forged Steel Barrels—DEMI-BLOC SYSTEM.'

Advertisement for a Home Made Alternating Current Motor. Text includes 'A Home Made Alternating Current Motor' and 'MUNN & COMPANY, 361 Broadway, New York, N. Y.'

Large advertisement for 'The World's Work' magazine. Features a circular graphic with 'John D. Rockefeller says: "I know of nothing more despicable and pathetic than a man who devotes all the waking hours of the day to making money for money's sake."' and 'The World's Work 25 cents a copy Buy it to-day!' Below this, it lists 'The Delineator' and 'Everybody's' magazines with prices.

I. H. C. Gasoline Engines

Simple, reliable powers adapted to all classes of mechanics.

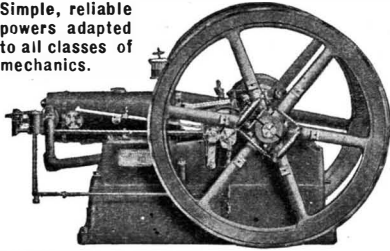

MAKE CERTAIN OF YOUR POWER
I. H. C. engines are dependable, easily controlled, economical of fuel, and require the minimum of attention.
Thorough factory tests and a guarantee from a company that cannot afford to send out engines that prove failures make you safe.
Vertical engines in 2 and 3 and 25-horse power.
Horizontal (Portable and Stationary) in 4, 6, 8, 10, 12, 15 and 20-horse power.
Call on local I. H. C. agents or write for catalog.
INTERNATIONAL HARVESTER CO. OF AMERICA
(Incorporated)
15 Harvester Bldg., Chicago, U. S. A.

SEALED PROPOSALS.

SEALED PROPOSALS will be received at the office of the Light-House Engineer, Tompkinsville, N. Y., until 1 o'clock P. M., Oct. 22, 1908, and then opened for furnishing one fourth-order lantern for Southwest Ledger Light-Station, New London Harbor, Conn., in accordance with specifications, copies of which, with blank proposals and other information, may be had upon application to the Light-House Engineer, Tompkinsville, N. Y.

LET US BE YOUR FACTORY
STAMPINGS, MODELS, EXPERT WORK
THE GLOBE MACHINE AND STAMPING CO.
970 Hamilton St., Cleveland, O.

ICE MACHINES Corliss Engines, Brewers' and Bottlers' Machinery. THE VILTER MFG. CO., 899 Clinton St., Milwaukee, Wis.

MODELS & EXPERIMENTAL WORK. Inventions developed. Special Machinery. E. V. BAILLARD, 24 Frankfort Street, New York.

RUBBER Expert Manufacturers Fine Jobbing Work
PARKER, STEARNS & CO., 228-229 South Street, New York

ELECTRIC GOODS.—Big Cat. 3 cts. Want Agents. Ohio Electric Works, Cleveland, O.

HOEFT & COMPANY
Die Makers, Machinists and Machinery Builders
120 Michigan St., Chicago, U. S. A.

DIE MODELS SPECIAL WORK TOOLS MACHINERY
If made in metal, we can make it.
NATIONAL STAMPING AND ELECTRIC WORKS.
158-159 S. Jefferson Street, Chicago, Ill.

MOORE & CO. Special Machinery, Dies, Tools, Models, Metal Specialties, Inventions perfected. Indiana and Franklin Streets, Chicago, U. S. A.

MODELS & EXPERIMENTAL WORK, Gears, Dies, Tools, Novelty manufacture. M. P. SCHELL, 1759 Union Street, San Francisco

MODELS & GEARS INVENTIONS PERFECTED UNION MODEL WORKS 193 So. CLARK ST. CHICAGO.

Telegraphy Circular free. Wonderful automatic teacher. 3 styles \$2 up. **OMNIGRAPH CO.**, Dept. 52, 89 Cortlandt St., New York.

Do Your Own Printing \$5 press prints cards, labels, etc. Circular, book, newspaper press \$18. Money saver, maker. All easy. Rules sent. Write factory for press catalog, type, paper, etc. **THE PRESS CO.**, Meriden, Conn.

"DOLLARS & SENSE" FREE. "DOLLARS & SENSE" (COL. HUNTER'S GREAT BOOK) free with ADVERTISERS MAGAZINE one year at 50 cents. Indispensable to business men who advertise. Best "Ad-School" in existence. Sample magazine free. ADVERTISERS MAGAZINE, 755 Commerce Building, Kansas City, Mo.

Chemical Analyses Industrial products examined and working formulas provided, processes improved, counsel and expert evidence. Assay of ores, alloys, water and fuels, etc., etc. Inventors assisted, instruction. Established 1882. **Monadnock Laboratory, Chicago.**

Electric Dynamos and Motors Send for Catalogue No. 45
KESTER ELECTRIC CO.
Terre Haute, Ind., U. S. A.

A Home Made Alternating Current Motor

READ SUPPLEMENT 1688 for a good, clear article by F. E. WARD, E.E., on the making of a 1/2 horse power alternating current motor. The motor can be constructed by anyone of ordinary skill in the use of tools, who has access to a screw-cutting lathe with a swing of 9 inches or more. The motor is designed to run on the 100 to 120 volt 60-cycle, single-phase alternating current circuit, now in widespread use for the lighting of dwellings. The motor will drive a 16-inch brass fan, a small lathe, or a 50-watt dynamo for generating direct current for charging storage batteries, and in fact will do almost any kind of work that can be done by one-man power. Order from your news-dealer or from
MUNN & CO., 361 Broadway, New York

Wire making machine, barb, A. L. Kitzel-mau 899,542
Wood carving machine, W. J. Egan 899,519
Wood, preserved, P. C. Reilly 899,904
Wood, vulcanizing, C. Howard 900,017
Wool washing machinery, squeeze roll for, I. F. Burnham 900,055
Woven fabric, I. E. Palmer 900,036
Wrench, I. H. Alfrey 899,707
Wrench, J. Reif, Jr. 899,805

DESIGNS.

Badge, J. Sablin 39,584
Badge or similar article, A. W. Southard 39,585
Bird cage, L. H. Johnson, Jr. 39,596
Cabinet, A. A. Low 39,593
Emblem, campaign, E. J. Pospisil 39,586
Emblem or similar article, C. B. Braunstein 39,587
Glove, C. Leppert 39,597
Hat fastener, lady's, M. E. Purdy 39,589
Implement holder, A. A. Low 39,591
Powder container cap, F. S. Hyatt 39,590
Shade holder, H. E. Watkins 39,592
Silverware border, J. E. Straker, Jr. 39,588
Stove, E. B. Colby 39,595
Trimming, W. Helbig 39,598
Vehicle seat, W. H. McIntyre 39,594

TRADE MARKS.

Agricultural machinery, Foss Manufacturing Co. 70,728
Antiseptic dusting powder, Sharp & Dohme 70,719
Antiseptic emollient, Sharp & Dohme 70,718
Antiseptic preparation, Aktiebolaget Barnangens Tekniska Fabrik 70,711
Automobiles, Oesterreichische Daimler-Motoren-Gesellschaft Gesellschaft mit beschränkter Haftung 70,779
Beverage, malt, Evansville Brewing Association 70,727
Biscuits, crackers, and bread, Hess Biscuit & Bread Co. 70,730
Risculs or crackers, J. S. Ivins' Son 70,732
Bitters, orange, G. Stiegler & Co. 70,747
Bread and crackers, dog and puppy, Potter & Wrightington 70,746
Brushes, paint, C. W. Snow & Co. 70,701
Canned fruits and vegetables, Burton & Davis Co. 70,723
Canned fruits and vegetables, J. F. Pyle & Son 70,740
Canned salmon, North Pacific Trading & Packing Co. 70,739
Catalogue, serial, Missouri Glass Co. 70,763
Chandeliers, Chas. Polacheck & Bro. Co. 70,724
Cigarettes, Ware-Kramer Tobacco Co. 70,709
Cigars, Smetzer Cigar & Tobacco Co. 70,708
Cigars, cheroots, and little cigars, H. Burger Cordials, G. Aquino 70,699
Corsets, Wright Formette Co. 70,722
Cotton dress goods, L. Hess & Co. 70,778
Disinfectants and vermin-exterminators, F. J. Herr 70,716
Engine under water exhausts, C. B. Chatfield 70,700
Feed, gluten, Corn Products Refining Co. 70,725, 70,726
Felt roofing, Barrett Manufacturing Co. 70,698
Fish hooks, O. Mustad & Son 70,704
Flour, wheat, Longmont Farmers Milling & Elevator Co. 70,733 to 70,735
Flour, wheat, Tacoma Grain Co. 70,743
Glassware, certain, Opalite Tile Co. 70,706
Headgear frames, Cream City Bonnet Frame Works 70,754
Horse blankets, Kneeder & Co. 70,745
Insulated wire, National India Rubber Co. 70,737, 70,738
Lamps, electric, R. E. Dietz Co. 70,741
Leather, tanned and dressed, H. W. Clark 70,751
Liniment, M. W. Barker 70,712
Liniment, Coffin & Schamerhorn 70,715
Liniment, oil, Dr. J. H. McLean Medicine Co. 70,753
Lock washers, Positive Lock Washer Co. 70,738
Medicated bathing fluid, G. Buckle 70,713
Medicinal preparation, certain, J. J. Vetter Milk, cream, buttermilk, butter and cheese, White Springs Farm Dairy Co. 70,744
Music, sheet, L. C. Kussner 70,761
Musical instruments, certain, Puntney & Eutsler 70,776
Painters' materials, certain, A. J. Lucas 70,703
Paper, blotting, Wrenn Paper Co. 70,710
Peanuts and peanut butter, Squirrel Brand Co. 70,760
Pipes, tobacco, Peach Pipe Co. 70,707
Plastic compound, certain, G. E. Walter Co. 70,757
Powder, tooth, Sharp & Dohme 70,717
Refrigerators, Norvell-Shapleigh Hardware Co. 70,705
Remedy and hair restorer, dandruff, D. R. Campbell 70,749
Remedy for certain diseases, Chicago Pharmaceutical Co. 70,714
Remedy for headache, O. L. Sherer 70,720
Rubber belting, hose, and machinery packing, Anchor Packing Co. 70,748
Sheetings and drillings, Exposition Cotton Mills 70,756
Sheetings, shirtings, drills, etc., China & Japan Trading Co. 70,750
Shoes, cloth, leather, and rubber, National Shoemakers 70,764
Silk fabrics, woven, Phalanx Silk Mill 70,765
Soap, Gillette Safety Razor Co. 70,758
Soap, M. E. Taylor 70,777
Soap, laundry, Procter & Gamble Co. 70,767 to 70,775
Soups, evaporated, J. W. Spence 70,742
Tobacco, granulated smoking, Rhedival Co. 70,702
Tonic beverage, F. H. Keron 70,731
Tools, certain, Collins Co. 70,752, 70,753
Umbrellas and parts thereof, Looming Wire-less Umbrella Co. 70,736
Velvetees, J. Hallworth & Son 70,759
Vinegar, malt, Grimble & Co. 70,729

LABELS.

"Daniel's P. P. P. Rod Packing," for rod packing, C. A. Daniel 14,382
"Elfenbrau," for beer, C. & J. Michel Brewing Co. 14,374
"Keystone," for condensed milk, Lackawanna Dairy Co. 14,377
"Navajo," for canned corn, McCord Mercantile Co. 14,378
"Pond Lily," for cold cream, S. M. Sargeant 14,370
"Queen Alexandrias of Judea Royal Rice Powder," for face powder, J. L. De Zeabault 14,380
"Queen Alexandrias of Judea Sweet Florentine Powder," for tooth powder, J. L. De Zeabault 14,381
"Royal Floor Wax," for wax for polishing floors, woodwork, and furniture, E. A. Bromund 14,383
"Sporting Extra," for cigarettes, H. Lakowetzky 14,376
"Table Rock Mineral Water," for natural mineral water, J. P. Porter 14,375

PRINTS.

"Aristos Red Turkey Wheat Flour," for wheat flour, Southwestern Milling Co. 2,352
"Don't Crow," for teas and coffees, James Van Dyk Co. 2,351
"Merion Butter," for butter, W. R. Lees & Bro. 2,353
"Ours is a Record of Victory with Victor Records," for disk records, G. A. Stanley 2,354

A printed copy of the specification and drawing of any patent in the foregoing list, or any patent in print issued since 1863, will be furnished from this office for 10 cents, provided the name and number of the patent desired and the date be given. Address Munn & Co., 361 Broadway, New York.

Canadian patents may now be obtained by the inventors for any of the inventions named in the foregoing list. For terms and further particulars address Munn & Co., 361 Broadway, New York.

You Have Your Organization At Your Finger Tips
with a
WESTERN ELECTRIC
Intercommunicating Telephone System.

No matter how finely a business house may be organized and systematized, it is necessary that intercourse be easy between heads of departments in order to settle the hundred and one unforeseen problems that arise daily in every business.
A Western Electric Intercommunicating Telephone System actually puts your organization at your finger tips.
Western Electric Intercommunicating Telephones are furnished in both wall and desk types. They are inexpensive to install, reliable in operation, and of low maintenance cost. They are of the high quality standard adopted by the largest operating telephone companies.
Write for Booklet No. 5002 on Intercommunicating Telephone Systems for Business and Residence Use.
WESTERN ELECTRIC COMPANY
261 S. Clinton St., Chicago 465 West St., Dept. 680, New York

American Homes and Gardens

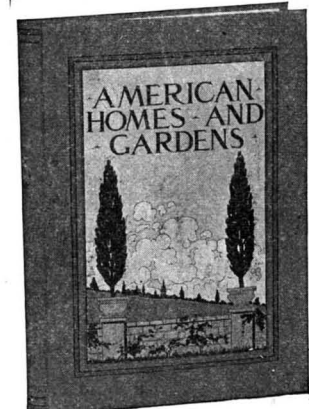

gives its readers the experience of experts in solving the most difficult HOME PROBLEMS. It is a thoroughly practical magazine having the word "Home" for its keynote.

How to Build the Home
Floor plans and details of construction of houses of moderate cost as well as more pretentious mansions are a feature of each issue.

How to Decorate the Home
The most experienced decorators in the country describe how the best and most artistic results are attained from the point of expenditure, and the more important one of satisfaction.

How to Plan and Lay Out the Garden
The frame of the House-picture is the garden, and success in its treatment means that each tree and shrub is correctly placed as well as properly grown, hence this department will be found most helpful.

Outdoor Life and Amusements, Articles on House Industries, every phase of country life is authoritatively discussed from month to month in its pages. "American Homes and Gardens" is conceded to be the handsomest magazine published in America. Its illustrations are largely reproductions of original photographs printed in duo-tone. Its beautiful cover printed in colors changes each month, and is always a work of art. **Subscription price, \$3 per year.**

If you send us an order for a year's subscription now we will send you the November and December, 1908, numbers free, entering the subscription for the full year 1909.

Attractive Club Offers:

American Homes and Gardens, -	\$3.00	} Both to the same address
Scientific American, - - - -	3.00	
American Homes and Gardens, or	} 3.00	} Our price
Scientific American, - - - -		
World's Work, - - - - -	3.00	} \$5.35
Everybody's, - - - - -	1.50	
	\$7.50	

Address **MUNN & CO., No. 361 Broadway, New York**



WE MANUFACTURE, MOULDED AND SPECIAL RUBBER GOODS OF EVERY DESCRIPTION AND CAN FURNISH ANY SPECIAL RUBBER ARTICLE TO YOUR SATISFACTION

NEW YORK BELTING & PACKING CO. LTD.
91-93 CHAMBERS STREET, NEW YORK

THE COMFORT OF A BED Lies in the Mattress used

A good pillow helps—an Ostermoor Pillow helps a lot—but the body rest is on the mattress. Our experience of over fifty years of mattress making has developed, to the point of sleeping perfection, the **Ostermoor Mattress, \$15.**

A mattress that never humps or lumps; sags or bags. That is clean and keeps clean—a sunbath its only needed renovation. Germ-proof, vermin-proof, moisture-proof.

A mattress that is guaranteed by its makers—not only that it is as represented, but that it will and must satisfy you.

Send for our 144-page Book and Samples of Ticking, Free With them we send the name of your Ostermoor dealer. When you buy, be sure that the name "Ostermoor" and our trade-mark label is sewed on end of mattress. Then, and then only, will you have a genuine mattress. If your dealer has none in stock, we will ship direct, express prepaid, same day check is received. 30 Nights' Free Trial granted, money returned if dissatisfied. Send for our free book, "The Test of Time."

OSTERMOOR & CO., 237 Elizabeth St. New York
Canada: Alaska Feather & Down Co., Ltd., Montreal

The HOLSMAN "Goes Anywhere"

High Wheels Travel All Roads Because All Roads are Made to be Traveled by High Wheels

The Holsman is the original high-wheeled automobile. It will go where no other automobile of equal horse power can go—up any hill, over rocks, ridges or stumps, through deep mud, ruts or sand. **Winner in greatest 1908 Hill Climb in America.** Cheaper than a horse. Operation under 1c a mile. Upkeep under 10c a day. Solid rubber tires. No differential gears or friction clutches. A blacksmith can make all ordinary repairs. Every machine guaranteed. Built by the oldest and largest manufacturer of high-wheeled automobiles in the world. Annual sales over \$600,000. Write for catalogue and testimonials.

HOLSMAN AUTOMOBILE CO.
215 Monadnock Block, Chicago

\$550 Up



COLD GALVANIZING. AMERICAN PROCESS. NO ROYALTIES. SAMPLES AND INFORMATION ON APPLICATION.

Established 1870.



NICKEL AND Electro-Plating Apparatus and Material

Hanson & VanWinkle Co.,
Newark, N. J.
28 & 30 S. Canal St. Chicago.



GOERZ BINOCULAR "PAGOR"

The smallest and newest PRISM GLASS made. Has not its Equal. Possesses extraordinary sharpness and clearness.

Descriptive catalogue sent on request.

C. P. GOERZ AMERICAN OPTICAL CO.
52 Union Square, E., New York

CHICAGO, ILL. 1514 Heyworth Building
SAN FRANCISCO, CAL. 703 Claus Spreckels Building

Puts the Best Cutting Edge on Any Razor

There is a quality in the smooth surface of a Torrey Strop which gives a wonderfully fine edge to a razor—our free catalogue tells you about it. Once you shave with a razor stropped on a "Torrey," you know what is meant by a "perfect edge" and you know how to get it.

TORREY STROPS

are best. To use one, just before shaving, puts a razor in such fine trim that shaving is a luxury.

Torrey Strops can be had for 50c., 75c., \$1.00, \$1.50, \$2.00 and \$2.50, in style and quality to correspond with the price. Post-paid if your dealer doesn't have them, and a new strop or money back if not satisfied.

Ask for **TORREY STROPS and RAZORS**. Torrey's Oil-Edge Dressing will keep any strop soft and pliable. Price 15c. at dealers or mailed on receipt of price. Catalogue containing valuable information free.

J. R. TORREY & CO., Dept. G, Worcester, Mass.

If You Knew

what our engine would save you in time—work—money—you'd find out now about our **big 30-day Free Trial Offer** on the **Waterloo Boy**

the 5-year guaranteed gasoline engine

Write today for free catalogue and our big special offer.

Waterloo Gasoline Engine Company
Dept. 19
Waterloo, Iowa.



LAND OPENING!

Kansas City, Mexico & Orient Railway

IRRIGABLE LANDS IN THE FAMOUS PECOS VALLEY—PECOS COUNTY, TEXAS.

No Homestead or Residence Requirements

These lands may be entered in tracts of ten acres or multiples thereof at \$40 per acre on terms of \$16 down and \$8 per month—no interest—no taxes for five years, including perpetual water-right and proportionate ownership of the immense irrigation works, now building. Filings made without leaving home.

The "Orient" road now has over 800 miles built and in operation between Kansas City and the Pacific Coast in Mexico and will soon be in operation over its entire length and through these lands which will then command \$100 to \$500 per acre.

For full information regarding these lands and the "Orient" road enclose four cents in stamps to the

BOARD OF LAND COMMISSIONERS
751 Victor Bldg. Kansas City, Mo.



THE BEST LIGHT

Brighter than electricity or acetylene—cheaper than kerosene—makes and burns its own gas.

No GREASE, DIRT, SMOKE or ODOR. A safe, powerful, white, steady light—durable and handsome. Over 100 styles—every lamp warranted.

AGENTS WANTED EVERYWHERE.

THE BEST LIGHT CO., 87 E. 5th St., Canton, O.
Owners of Original Patents.



SEXTANT POCKET SIZE

Not a toy. Gives accurate results in Surveying, Navigation, etc. Invaluable to those interested in engineering. Price \$1.00.

L. DUERDEN, Port Washington, L. I., New York, U.S.A.



The Cushman

The "MOTOR OF MERIT"

Honestly Built Honestly Sold 2, 4, 8, 14 H.P.

They are made for the man who wants the best.

Cushman Motor Co.
2026 N. St., Lincoln, Nebr., U.S.A.

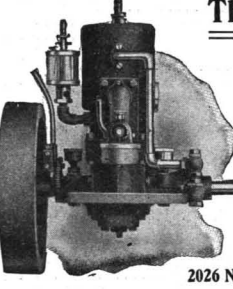

The New Automobile Supply House

Everything for the **AUTOMOBILE**

Write for our 1909 Advance Catalog Sheets

NEW GOODS, METHODS, PRICES AND LOCATION

The Automobile Supply Dept. of **THE BAUM IRON CO., 1224 Harney Street, Omaha, Nebraska**



ELECTRIC LAUNCH MOTOR.—THE design in this paper is for a motor of unusual simplicity of construction, which can easily be built by an amateur at small cost. It is intended for a boat of about 24 feet over all and 4 feet 6 inches beam, drawing 18 inches, and is capable of propelling such craft at a speed of 7 miles per hour. Illustrated with 21 cuts. See **SCIENTIFIC AMERICAN SUPPLEMENT, No. 1202**. Price 10 cents by mail, from this office and from all newsdealers

HOW TO MAKE AN ELECTRICAL Furnace for Amateur's Use.—The utilization of 110 volt electric circuits for small furnace work. By N. Monroe Hopkins. This valuable article is accompanied by detailed working drawings on a large scale, and the furnace can be made by any amateur who is versed in the use of tools. This article is contained in **SCIENTIFIC AMERICAN SUPPLEMENT, No. 1182**. Price 10 cents. For sale by **MUNN & CO., 361 Broadway, New York City** or by any bookseller or newsdealer.

HALF PRICE To Clean up Surplus Stock Semi Annual CLEARING SALE OF **Automobile Supplies and Accessories**

Send for Flyer No. 18

NEUSTADT AUTOMOBILE & SUPPLY CO.
3932 Olive Street St. Louis, Mo.

I WILL MAKE YOU PROSPEROUS

If you are honest and ambitious write me today. No matter where you live or what your occupation, I will teach you the Real Estate business by mail; appoint you Special Representative of my Company in your town; start you in a profitable business of your own, and help you make big money at once.

Unusual opportunity for men without capital to become independent for life. Valuable Book and full particulars FREE. Write today.

NATIONAL CO-OPERATIVE REALTY CO.
E. R. MARDEN President
K. B. Y. Marden Building Washington, D. C.



2HP Stationary \$29.50 Engine

Runs pumps, cream separators, churns, grist mills, corn shellers, washing machines, lathes, sawing machinery, etc. Uses alcohol, gasoline, naphtha, distillate, kerosene, etc. without change in equipment. Starts without cranking, drop-forged crank shaft, best grade rabbit bearings. Other sizes proportionate prices. Free catalog tells how to save half cost of hired help. All sizes in stock ready to ship.

Detroit Engine Works,
127 Bellevue Ave., Detroit, Mich.



Draughtsman's Protractor

This is a great tool for any draughtsman. It is instantly adjustable to any angle, and has a vernier reading to 5 minutes. It is so arranged that all parts are flush on the under side. Finished in dull nickel. Will be sent to any address, charges paid, for \$3.80.

GOODELL-PRATT CO., Greenfield, Mass.



GOES LIKE SIXTY SELLS LIKE SIXTY \$60

GILSON GASOLINE ENGINE

For Pumping, Cream Separators, Churns, Wash Machines, etc. FREE TRIAL. Ask for catalog—all sizes.

GILSON MFG. CO. 308 Park St. Port Washington, Wis.



Scissor-Pencil

Pencil-holder, point-protector and scissors combined. 4 1/2 ins. long. Scissors of high-grade steel; holder of brass heavily nickel-plated. Good quality pencil. Folds to take same space as ordinary pencil. Handy as cigar cutter. Impossible to tear pocket.

Opened in a second. A necessity to all. 50 cents postpaid. Sterling silver \$1.50. An ideal gift. Money back if not satisfied.

C. Schroedel, Manager, Scissor-Pencil Co., Rochester, N. Y.



Be Sure of Your Current

It means something to the owner of an auto, motor boat, or gas engine to feel his ignition current is strong, sure and reliable.

The **Huhler-Dayton Storage Battery** is indestructible, compact, simple, sure. Made in the factory that produces the famous Apple Battery Charger, the only satisfactory ignition dynamo. For complete information about either device, write

THE DAYTON ELECTRICAL MFG. CO.
98 St. Clair St., Dayton, Ohio



LUFKIN TAPES AND RULES ARE THE BEST.

For sale everywhere. Send for Catalog No. 16.

LUFKIN RULE CO.
Saginaw, Mich., U. S. A.
New York and London.



What Do You Want To Buy?

We can tell you where to buy anything you want. Write us for the addresses of manufacturers in ANY line of business. Novelties, Special Tools, Machinery, Equipments. New Patent LABOR-SAVING DEVICES.

MUNN & CO., Publishers of Scientific American
361 Broadway, New York, U. S. A.

UNCLE SAM is an Ideal Employer. Pays big salaries. Never cuts wages nor discharges help in hard times. Gives a full month's vacation with pay. Rewards efficiency by promotion. Only common school education needed to get one of these desirable life positions. Examination in every state soon. Our **"THE EASY BOSS,"** free booklet, gives full information regarding positions in all departments of the Government and how to obtain them. No tuition fee until appointed. **COMMERCIAL CORRESPONDENCE SCHOOLS,** 390 J Commercial Building, Rochester, N. Y.

ELECTRO MOTOR. SIMPLE, HOW TO make.—By G. M. Hopkins. Description of a small electric motor devised and constructed with a view to assisting amateurs to make a motor which might be driven with advantage by a current derived from a battery, and which would have sufficient power to operate a foot lathe or any machine requiring not over one man power. With 11 figures. Contained in **SCIENTIFIC AMERICAN SUPPLEMENT, No. 641**. Price 10 cents. To be had at this office and from all newsdealers.

Tools! Tools! Tools!

We keep all kinds. Send your name on a postal and get our 88-page Booklet

Montgomery & Co., 109 Fulton St., New York City

Engineering News (ILLUSTRATED)

The Leading Engineering Paper of the World. For Civil, Mechanical, Mining and Electrical Engineers. 100 to 125 pages, 9" x 13", weekly. Send ten cents for sample copy.

THE ENGINEERING NEWS PUBLISHING CO., 214 Broadway, New York

ALL THE NEWS OF MOTION PICTURES

Lecture and song slides every week in the leading journal of the trade.

Best Medium for Advertisers 10c per copy, \$2 per year.

MOVING PICTURE WORLD
125 E. 23d St., New York City



HELMETOIL LUBRICATES SEND FOR ANYTHING FREE

15-21 S. CLINTON ST. CHICAGO, ILL. U.S.A.

