

# SCIENTIFIC AMERICAN

Entered at the Post Office of New York, N. Y., as Second Class Matter. Copyright, 1907, by Munn & Co.

Vol. XCVII.—No. 18.  
ESTABLISHED 1845.

NEW YORK, NOVEMBER 2, 1907.

[ 10 CENTS A COPY  
\$3.00 A YEAR.]

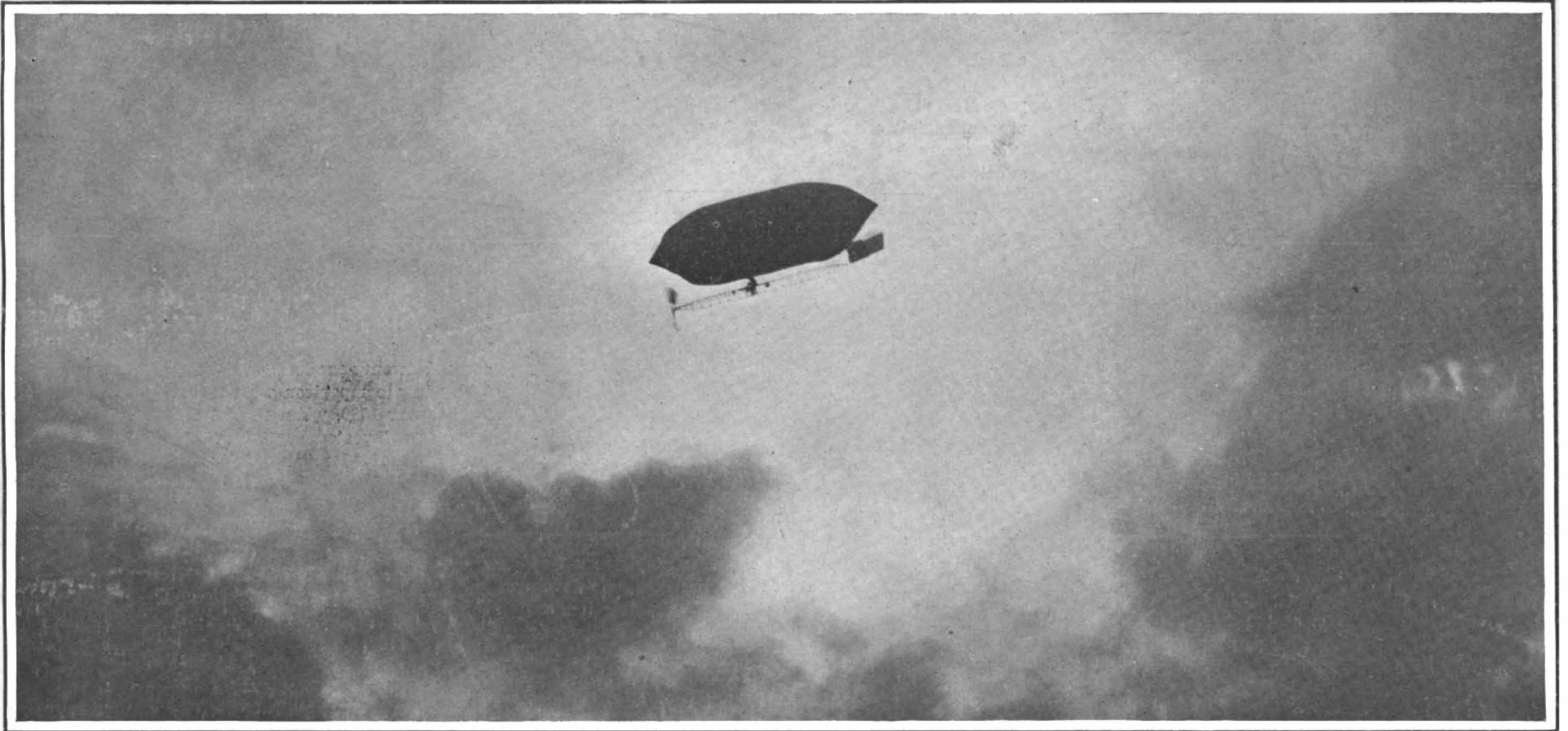

Cromwell Wilson's Skycycle Among the Clouds.

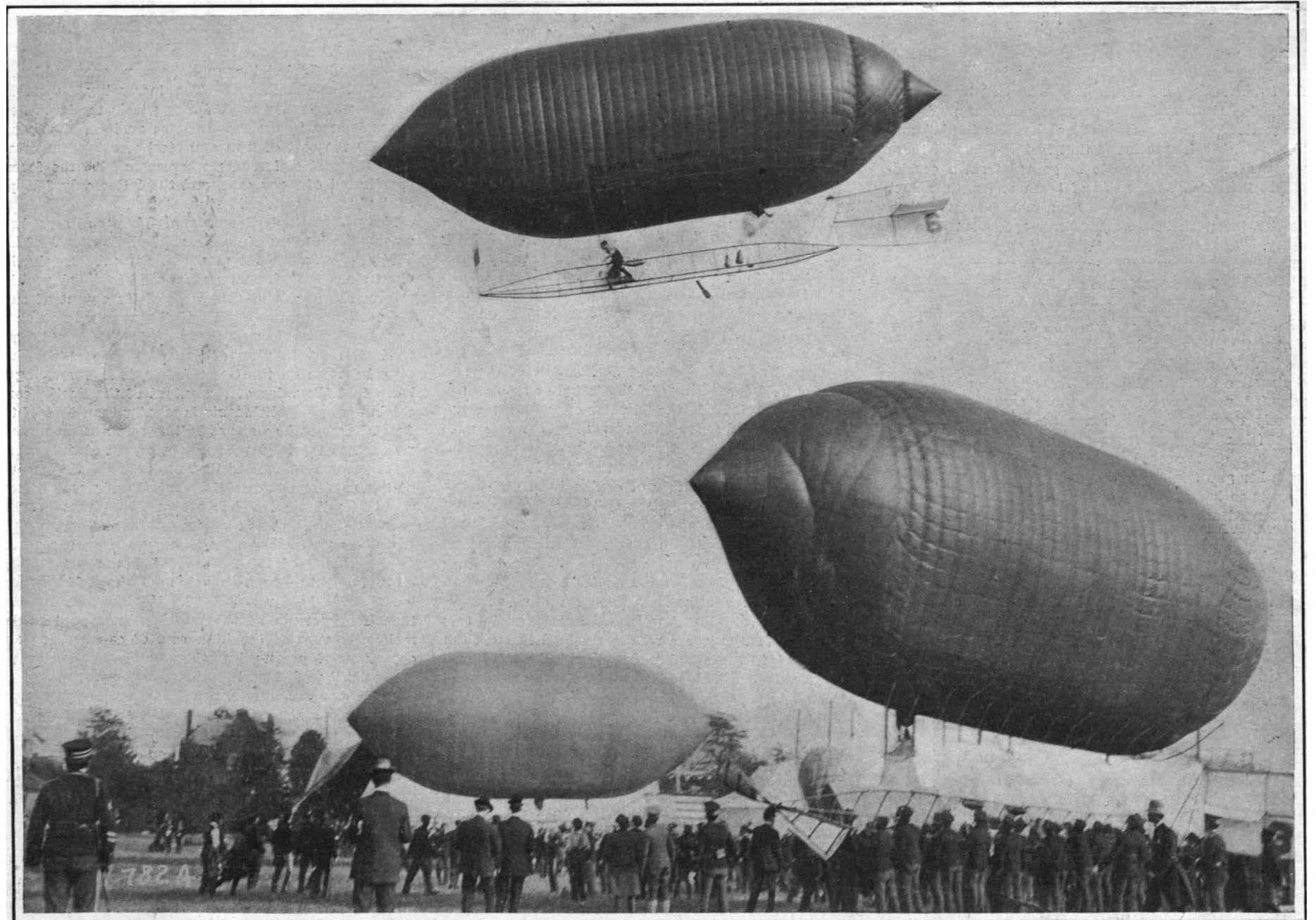

Beachey, the Winner, Descending in His Airship.  
THE LONG-DISTANCE BALLOON AND AIRSHIP RACES.—[See page 808.]

## SCIENTIFIC AMERICAN

ESTABLISHED 1845

MUNN &amp; CO. - - - Editors and Proprietors

Published Weekly at

No. 361 Broadway, New York

CHARLES ALLEN MUNN, *President*  
361 Broadway, New YorkFREDERICK CONVERSE BEACH, *Sec'y and Treas.*  
361 Broadway, New York

## TERMS TO SUBSCRIBERS

One copy, one year for the United States or Mexico. . . . . \$3.00  
 One copy, one year, for Canada. . . . . 3.75  
 One copy, one year, to any foreign country, postage prepaid, £018s. 6d. 4.50

## THE SCIENTIFIC AMERICAN PUBLICATIONS

Scientific American (Established 1845). . . . . \$3.00 a year  
 Scientific American Supplement (Established 1876). . . . . 5.00  
 American Homes and Gardens . . . . . 3.00  
 Scientific American Export Edition (Established 1878). . . . . 3.00  
 The combined subscription rates and rates to foreign countries, including Canada, will be furnished upon application.  
 Remit by postal or express money order, or by bank draft or check.  
 MUNN & CO., 361 Broadway, New York.

NEW YORK, SATURDAY, NOVEMBER 2, 1907.

The Editor is always glad to receive for examination illustrated articles on subjects of timely interest. If the photographs are sharp, the articles short, and the facts authentic, the contributions will receive special attention. Accepted articles will be paid for at regular space rates.

## PANAMA CANAL LOCKS TO BE WIDENED.

The advent to this port of a Cunard liner with a beam of 88 feet, and the recent placing of an order by the Hamburg-American Company for a transatlantic liner to have a beam of 90 feet, to say nothing of the fact that we have two battleships building whose beam is to be over 85 feet, have naturally directed the attention of the government once more to the question of the proper width to be given to the locks of the Panama Canal. It is the locks that determine the capacity of the canal; and seeing that the width at present decided upon is only 100 feet, the canal engineers have decided that a reasonable regard for the developments of the future makes it necessary to increase the width at least to 125 feet. Col. Siebert, one of the engineer officers attached to the Isthmian Canal Commission, and Civil Engineer Rousseau, the naval member of the Commission, have recently returned to the Isthmus after consultation upon this subject with the authorities at Washington. Although a width of 125 feet has not been finally decided upon, it is considered probable that the locks will not be built with dimensions less than this.

The desirability of giving ample width to provide for the needs of the future is emphasized by the fact that, in the towing-tank investigations made in connection with the design for the "Lusitania" and "Mauretania," it was found that in large vessels there was a decided advantage to be gained from a considerable increase of the ratio of beam to length, a fact which was also established at about the same time during independent investigations conducted in Germany.

## HOIST WITH ITS OWN PETARD.

In the development of war material it has more than once happened that weapons of destruction have shown that they can be quite as harmful to friend as to foe. A notable instance of this is found in the destructive effects which the larger pieces of artillery mounted upon warships sometimes exercise upon the vessels themselves. It is not an uncommon experience (though not so frequent of late years as it was a decade or two ago) for a new warship to return from her gun trials with a large proportion of her gun mounts so badly racked and loosened up by the recoil as to need a thorough readjustment, if not the design of new mountings and attachments. Equally, if not even more destructive has been the effect of the blast at the muzzle, where the impact of the expanding gases has proved sufficient to wreck superstructures, and bodily force down a large area of the deck of the ship. A recent instance of these destructive effects is recorded in *Cosmos* as having occurred in the Italian navy upon the old battleship "Morosini," now designated as a coast-defense vessel. The "Morosini" is one of the early battleships, upon which were mounted the huge 17 $\frac{3}{4}$ -inch 100-ton guns, manufactured by Armstrong, which created such a furor over two decades ago. According to our contemporary, the question had arisen as to what would be the effect upon the ship and crew of the simultaneous discharge of these four huge pieces; and it was resolved to put the matter to a thorough test. The "Morosini" carries her four guns in two turrets arranged *en echelon*, or diagonally, on the main deck amidships. Each one was loaded with a charge of about 770 pounds of powder, and at a given signal the four guns were discharged simultaneously, and the effects of the explosion of over 3,000 pounds of powder noted. The results as given by our contemporary must, we think, have been somewhat exaggerated, or else the guns had never be-

fore been fired with full charges. It is stated that there was considerable dislocation of the armor, rivets being started as by the pressure of an interior explosion, and that parts of the machinery were rendered inoperative. We think it is more than likely that this damage must have referred to that portion of the deck located below the muzzles of those guns which were trained across the deck. In this connection it is interesting to bear in mind that the three large cruisers of the "Invincible" type, which are being completed for the British navy, have four of their guns arranged to train across the deck. We understand that in reintroducing this system, special attention is being given to the strengthening of the deck and such portions of the ship as will be exposed to the impact of the gases. The Armstrong guns, referred to above, were built in the days of the old quick-burning powder, which gave a high breech pressure but low muzzle pressure. In these days of smokeless powder, where the muzzle pressures are high, the racking effects of "blast" are proportionately more severe, and call for special structural strength in the parts of the ship that may be affected.

## THE HUMANITARIAN SIDE OF VIVISECTION.

If the cure of disease and the prolongation and saving of life are worthy of the efforts of philanthropy, the founding of institutions for medical research by the aid of vivisection is a humanitarian act that cannot be too highly commended. The opposition of the Anti-Vivisection Society to the project of the Rockefeller Institution for establishing a farm in New Jersey, on which to raise animals for vivisection, is prompted, no doubt, by the best of motives; but it is an opposition which is founded upon ignorance and prejudice. The attitude of the anti-vivisectionists is due largely to an ungenerous, but too widely prevalent, conception of the spirit in which medical science pursues its investigations, particularly when they are directed to the field of research in which vivisection is practised. We have even heard it stated that the men who devote themselves to research by the aid of vivisection are prompted by motives of curiosity and an undue propensity for the use of a knife. We believe that, as a matter of fact, in the whole range of scientific investigation, it would be difficult to find a body of men who bring to their work a more sincere desire for the amelioration of the human race, or who follow their quest with more unselfish zeal and with less prospects of those pecuniary rewards which form the stimulus of most of the activities of life.

It is a well-recognized law of nature, everywhere to be observed, that the few are frequently called upon to suffer for the great good of the many; and it is by the sanction of this law that the temporary suffering inflicted upon animal life in vivisection is recognized as being merely an incident in the accomplishment of one of the most beneficial triumphs of medicine that the world has known. Were vivisection abolished, some of the noblest results of the past fifty years of medical research would be swept away, and several of the most terrible diseases would be given free rein to inflict their scourge upon mankind.

The small animals, upon which vivisection, if such it can be called, is practised, are used in the laboratories to test the anti-toxins, and also in the preparation of the Pasteur vaccines for the prevention of hydrophobia. Thus, at the Research Laboratory of the Department of Health of New York, most of the animals are used for testing diphtheria toxin; and according to Dr. W. H. Park, the Director of the Laboratory, there is absolutely no other way in which this anti-toxin can be tested. As the result of past experimental work on these animals and the use that is now being made of them, the number of deaths from diphtheria has been reduced to about twenty-five per cent of what it was twelve years ago. The guinea pigs are used also in the treatment of tetanus, or lockjaw; and as the result of experiments carried on with these little creatures, lockjaw has been practically wiped out in New York city. Formerly, some twenty-five or more persons died from lockjaw in a single year in this city. Now, thanks to the results obtained through the practice of this much-abused and utterly misunderstood vivisection, not one of the patients who were subjected last year to the anti-toxin treatment died, and the Director pertinently asks: "Are not the lives of twenty-five or more persons well worth the sacrifice of the lives of a few guinea pigs?" So also in the treatment of hydrophobia, the vaccine for its prevention can be prepared in only one way, usually by the use of rabbits; and frequently the only method of determining whether a dog has rabies is to inoculate a guinea pig with the virus from a dog's brain. This is done in the comparatively rare cases where the microscope fails to give the necessary information. The results in this particular case speak for themselves; for, whereas in untreated cases the death rate is twenty per cent, in New York city out of one thousand cases treated the death rate has been but one per cent. The government, moreover, sets its sanction

upon the use of animal tests by requiring that its vaccines, before they are placed upon the market, shall be tested by this method to insure their freedom from the virus of tetanus.

## SHIPBUILDING IN THE UNITED STATES.

In spite of the fact that the greater part of our trade with other countries is carried in foreign bottoms, the shipping industry of the United States, thanks to our ever-increasing coastwise and river and lake traffic, continues to make satisfactory progress. The statistics recently published by the Bureau of the Census on shipbuilding, covering the year 1904-5, show that 1,097 establishments, outside of those conducted by the government, were engaged in iron and steel or wooden shipbuilding. These establishments represented a total capitalization of over 121 million dollars; they employed over 50,000 wage earners, to whom was paid over 29 million dollars in wages; the materials cost over 37 million dollars; while the finished products were valued at 83 million dollars.

In any estimate of the progress of shipbuilding in the United States, it is customary to go back to the period immediately preceding the civil war, when this country led the world in the extent and quality of its shipping. In the present case a comparison of the above figures with those of the census of 1850 shows that the industry, in spite of our relative backwardness in the carrying of over-sea commerce, has made remarkable progress; for the capital invested has increased twenty-one-fold, and the product nearly four-fold. In a comparison with the status of shipbuilding in the year 1880, when the 2,188 establishments represented an invested capital of 21 million dollars, and an output of 37 million dollars, shipbuilding twenty-five years later represented nearly six times the amount of capital, invested in about one-half the number of establishments, and its output had increased to 83 million dollars.

The figures showing the decrease of wooden and increase of iron and steel construction are interesting; for we find that whereas in 1900, of the entire shipbuilding of the country 77.4 per cent was invested in iron and steel construction, in 1905 the proportion had risen to 83.5 per cent. That the majority of the establishments engaged in iron and steel construction require costly and expensive equipment, while most of those engaged in wooden construction are small yards which perform minor repairs on small vessels, and turn out wooden vessels of comparatively light tonnage, is proved by the fact that of the total number of 1,097 private establishments reported in 1905, 1,043 were engaged in wooden construction work, and 83.5 per cent of the total shipbuilding capital was represented by the other 54 establishments. The increasing importance of iron and steel in shipbuilding within the last fifteen years is seen in the fact that, as an item of expense, in 1890 the cost of iron and steel was less important than the cost of lumber; whereas in 1905 the former constituted 41.2 per cent, and the latter only 17.9 per cent of the amount paid for material.

New York and Pennsylvania have always been among the leading States in shipbuilding; and of late Virginia has made the most striking progress, having risen since 1880 from twenty-second to third position among the States in the value of its output of shipping. Nearly three-fourths of the aggregate value of completed ships is now produced in the Atlantic and Gulf district. In view of the magnitude of the shipping interests on the Great Lakes, it is surprising to learn that the value of the output of the Pacific coast shipbuilding establishments is greater than that of the Great Lakes. The work of building up a great navy is reflected in the total value of the output of the government yards, and we find that the value of the product of the government establishments has increased from about 11 millions in 1900 to over 17 millions in 1905, or 56.6 per cent. The increase in size and cost of merchant vessels is shown by the fact that, whereas the average value of the 2,415 vessels launched in 1880 was \$7,961, the average value of the 2,248 vessels launched in 1905 was \$32,683. It cannot be disputed that the interests of the merchant marine languish mainly because of the high cost of construction and operation of ocean-going ships, and the consequent impossibility of American built and manned vessels competing successfully against those of foreign nations without the assistance of some form of subsidy; and, indeed, it is chiefly the fact that vessels for the coastwise, lake, and river service are required by law to be American-built that has made it possible for shipbuilding to maintain as firm a footing as it has in this country.

The French airship "Patrie," in a two hours' flight on July 21, carried out a number of evolutions in connection with the use of guide ropes and coming to earth at a given spot in the shortest time possible. The airship once came down to within 3 feet of the earth, and then rose rapidly to 300 feet. It was brought to earth from that height within fifteen minutes.

THE HEAVENS IN NOVEMBER.

BY HENRY NORRIS RUSSELL, PH.D.

The most interesting astronomical event of this month is undoubtedly the transit of Mercury, which takes place on the morning of the 14th. At this time the planet comes directly between us and the sun, so that it appears as a small round black spot upon his disk, which moves across it to the westward. If it went across the middle of the sun's disk, it would take nearly six hours to make the journey; but in the present case it passes far to the north of the center, and its line of motion cuts off a little slice of the northern limb, whose width is only about one-tenth of the sun's diameter. In consequence the duration of the transit is much reduced, and it lasts absolutely less than three hours and a half.

We are not very well placed to view the proceedings, for the sun does not rise at Washington until the transit is nearly half over. Its later stages, and especially the egress of the planet, which occurs at about 8:48 A. M. (Eastern standard time), should, however, be easily seen, weather permitting.

The apparent diameter of the planet is so small—less than ten seconds of arc—that it will be invisible without a telescope, but with instrumental aid and suitable shade glasses it should be visible as a small dot, only about 1/200 of the sun's diameter. It takes about 2 minutes and 40 seconds to pass over the edge of the sun—which it approaches very obliquely—and this will be the most interesting part of the affair to watch, provided one has a telescope of sufficient power.

Transits of Mercury, while by no means as rare as those of Venus, are unusual enough to be somewhat of a rarity to the amateur astronomer. If the orbits of Mercury and the earth were in the same plane, the planet would transit over the sun at every inferior conjunction, that is, three times a year. But his orbit is actually more inclined than any other among the principal planets, and in consequence he usually appears to pass north or south of the sun at conjunction rather than directly in front of him, and transits can only occur when the conjunction takes place near the nodes of his orbit, which the earth reaches on May 7 and November 9. At the May transits the planet is much nearer us than in November, and he has consequently to pass much closer (in miles) to the line joining the earth and the sun's center, in order to appear projected on the latter's disk. It follows that the May transits are much less frequent than the November ones. For example, there were four of the former and nine of the latter during the nineteenth century.

After thirteen years the earth and Mercury come around into nearly the same positions they occupied at first, and after forty-six years they do so almost exactly. The transits, therefore, are often repeated after thirteen years, and almost always after forty-six.

THE HEAVENS.

Looking at our map, we see that the Milky Way forms a great arch across the sky from east to west, passing north of the zenith. Right in its center, high up in the west, is the great cross of Cygnus the Swan. Below this is the bright star Vega in Lyra, and on the right is Altair in the Eagle. Hercules is setting in the northwest, and Capricornus the Sea Goat is low in the southwest. The brilliant red object in this region is the planet Mars.

Aquarius the Water Bearer is to the right, and below him is the Southern Fish, with the isolated bright star Fomalhaut. Above, and nearly overhead, is the great square of Pegasus. Saturn, which is in Aquarius, about midway between Fomalhaut and  $\gamma$  Pegasi, is brighter than any star for a long way around.

In the southeastern sky is Cetus the Whale. The star  $\tau$  in this constellation is one of our nearest neighbors in space, its distance being about nine light

years, and the star  $\sigma$  is the famous variable Mira. A maximum of this star is due this month, and it will be interesting to compare its brightness with that of last December, when for a week or two it was the brightest star in the constellation. In the meantime it has been as faint as the ninth magnitude; that is, less than one-twentieth as bright as the faintest stars visible to the naked eye.

Eridanus, now rising in the east, is not yet well seen; and the Phoenix and the Crane, though conspicuous southern constellations, are so low that we never see them at any advantage.

Orion is just rising, due east, and so is Gemini, farther to the north. Taurus the Bull is above the former, and Auriga the Charioteer above the latter. Still higher are Perseus in the Milky Way and Aries the Ram south of it. Andromeda is right overhead, and the Great Nebula is almost exactly in the zenith. Of the circumpolar constellations, Cepheus and Cassiopeia are above the pole, Ursa Minor and Draco to the left of it, and the Great Bear below it on the horizon.

THE PLANETS.

Mercury is evening star until his transit on the 14th, and afterward morning star. At the end of the month he is easily visible in the morning sky, rising

by Mellish at Madison, Wis., on the morning of October 14. It was at that time in R. A. 8h. 31m. Declination, 9 deg. 24 min., south, and moving slowly northwestward. It rises before 2 A. M., and may be observed in the morning hours. It cannot yet be told whether, like Daniel's comet, it will become conspicuous, or whether, like the majority of comets, it will remain faint.

Princeton University Observatory.

ARTIFICIAL HONEY.

Prof. Herzfeld, of Germany, recently brought out some interesting points regarding the manufacture of artificial honey in Europe. It is noticed that when we bring about the inversion of refined sugar in an almost complete manner and under well-determined conditions, this sugar solidifies in the same way as natural honey after standing for a long time, and it can be easily redissolved by heating. Owing to the increased production of artificial honey, the bee cultivators have been agitating the question so as to protect themselves, and it is proposed to secure legislation to this effect, one point being to oblige the manufacturers to add some kind of product which will indicate the artificial product. On the other hand, it is found that the addition of inverted sugar to natural

honey tends to improve its quality and especially to render it more easily digested. Seeing that sugar is about the only alimentary matter which is produced in an absolutely pure state, its addition to honey cannot be strictly considered as an adulteration. Bees often take products from flowers which have a bad taste; and the chemist Keller found that honey coming from the chestnut tree sometimes has a disagreeable flavor. From wheat flowers we find a honey which has a taste resembling bitter almonds, and honey from a sparagus flowers is most unpalatable. Honey taken from the colza plant is of an oily nature, and that taken from onions has the taste of the latter. In such cases, the honey is much improved by the addition of inverted sugar. Prof. Herzfeld gives a practical method for preparing this form of sugar. We take 1 kilogramme (2.2 pounds) of high-quality refined sugar in a clean enamel-ware vessel, and add 300 cubic centimeters (10 fluid ounces) of water and 1.1 grammes (17 grains) tartaric acid. This is heated at 110 deg. C. over an open fire, stirring all the while, and is kept at this heat until the liquid takes on a fine golden yellow color, such operation lasting for about three-quarters of an hour. By this very simple process we can easily produce artificial honey. Numerous extracts are now on the market for giving the aroma of honey, but none of them will replace the natural honey. However, if we take the artificial product made as above and add to it a natural honey having a strong aroma, such as that which is produced from heath, we can obtain an excellent semi-honey.

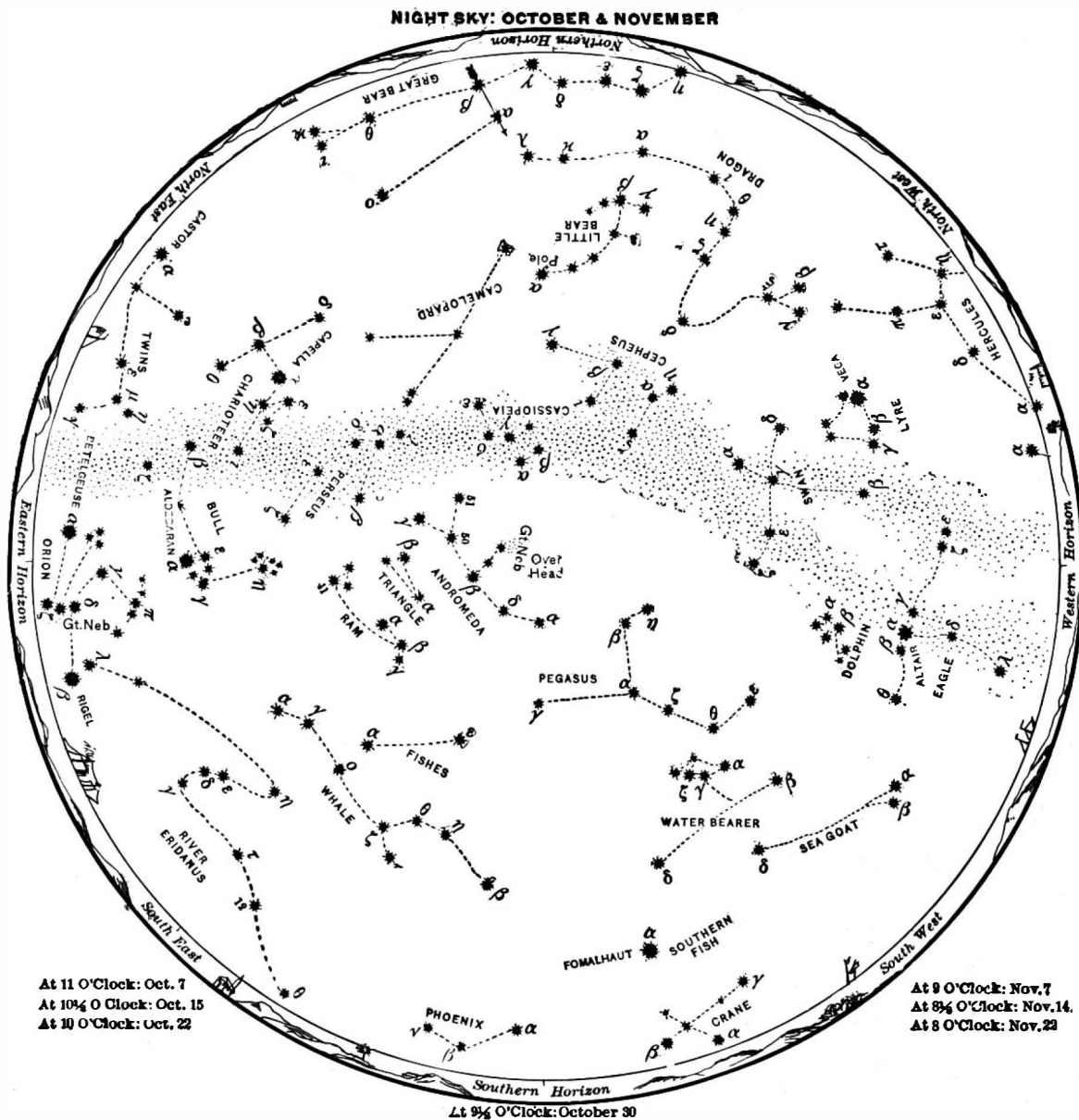

In the map, stars of the first magnitude are eight-pointed; second magnitude, six-pointed; third magnitude, five-pointed; fourth magnitude (a few), four-pointed; fifth magnitude (very few), three-pointed, counting the points only as shown in the solid outline, without the intermediate lines signifying star rays.

about 6 A. M. Venus is evening star, but is still so near the sun and so far south as to be seen with difficulty.

Mars is in Capricornus, and is conspicuous in the southwestern sky early in the evening. On the 11th he is in quadrature with the sun, and comes to the meridian at 6 P. M.

Jupiter is also in quadrature during the month, on the 5th, but being west of the sun, he souths at 6 A. M. and is to be seen only after 11 P. M.

Saturn is in Aquarius, and is due south about 8 P. M. in the middle of the month.

Uranus is in Sagittarius, too near the sun to be well observed. Neptune is in Gemini, and comes to the meridian about 3:30 A. M. in the middle of the month.

THE MOON.

New moon occurs at 6 P. M. on the 5th, first quarter at noon on the 12th, full moon at 7 P. M. on the 19th, and last quarter at 11 P. M. on the 27th. The moon is nearest us on the 9th and farthest off on the 25th. She is in conjunction with Venus and Mercury on the 6th, Uranus on the 9th, Mars on the 12th, Saturn on the 14th, Neptune on the 23d, and Jupiter on the 26th.

A comet, visible in an opera glass, was discovered

THE SCIENTIFIC AMERICAN TROPHY AND MEDAL.

The SCIENTIFIC AMERICAN Trophy for airships heavier than air was placed on exhibition at the Grand Central Palace on October 24 at the exhibition of the Aero Club of America. The trophy is attracting much attention, and illustrations of it have appeared in all the principal papers in this country and abroad. It is conceded that it is the most beautiful aeronautical trophy ever offered.

The SCIENTIFIC AMERICAN gold medal for devices for saving life and limb was formally turned over to the American Institute of Social Service at a meeting of the Advisory Council held in the new Museum of Safety Devices in the 39th Street building, New York, on October 25. Interesting details of the rules governing exhibits and of the competition will be published later.

**THE CROCCO AND RICALDONI HYDROPLANE BOAT.**

Through the courtesy of Capt. Mario Ricaldoni we are enabled to present the accompanying illustrations of the Crocco-Ricaldoni hydroplane. Built in the yard of M. Baglietto, at Varazze, on the Gulf of Genoa, the craft has been run on the Lake of Bracciano, near Rome.

The length of the boat is 8 meters (26 feet 3 inches). She is fitted with a Clément-Bayard 80 to 100 horse-power motor, having cylinders 180 millimeters by 180 millimeters (7.09 inches by 7.09 inches), and working at a speed of 1,200 revolutions per minute. The boat is provided with hydroplanes only at the bow and stern. The planes at the bow are arranged in the manner of a V, while those aft, though similarly disposed, do not join at the inverted apex. These planes, and the principal members of the frames supporting them, are made of steel plating, the remaining parts of the carrier frames being of aluminium. One of our views shows an end-on view of the vessel and depicts the low V-shaped plane. The aerial propellers are of doubled aluminium plating, and weigh each about 12 kilogrammes (26.4 pounds). Their pitch can be altered while running, and they can be reversed. The propellers are mounted on frames of aluminium sheeting, which, together with the shafts, gear, transmission, and controlling devices, etc., weigh 300 kilogrammes (660 pounds). The weight of the motor is also 300 kilogrammes (660 pounds). Including all machinery, fuel, etc., and two men on board, the vessel weighs 1,500 kilogrammes (3,300 pounds). When running, the boat rises, so that the hull is clear of the water, and at the speed of 70 kilometers per hour (43.5 miles per hour) which has been obtained with this novel form of vessel, the hull is about 18 inches out of the water. The view of the boat under way shows her at full speed, supported solely by the V-shaped planes, the hull being clear of the water as described. We

are informed by the inventors of this boat that on commencing a run, when a speed of about 10 kilometers (6.2 miles) per hour is attained, the bows begin to lift in the water, and the fore fins slowly emerge as the speed increases. At a speed of 25 kilometers (15.5 miles) per hour the hull is wholly out of the water, only the flat portion near the stern skimming on the surface. At from 30 to 35 kilometers (18.6 to 21.7 miles) the boat is supported solely by

"The Papal Car." It was originally built and furnished to be used by the Pope on his journeys—at a time when His Holiness did not choose to remain a voluntary prisoner in the Vatican; and it is not impossible that Pius IX. may have used it before 1870, on some of his not very numerous nor very extensive journeys. Like the papal horse-drawn carriages, it is distinguished from the generally very lightly-built Italian railway carriages by its extreme size and weight. It was done up in sky blue, with the figure of an angel at each corner; and was both richly and gorgeously fitted up. Provision was made for all needs and comforts of the Pope; there was even a private altar, in case His Holiness should want to read Mass when under way.

This car has disappeared as thoroughly as mysteriously; and no one knows—or will say—where it is. At the Milan Exhibition of 1906 there was a retrospective exhibit of transportation of the nineteenth century, and it was intended to show the papal car; but during the negotiations to this effect the Italian private railways passed into the possession of the State, which latter refused permission to have

the car exhibited. Since that time the Italian government and the Florentine general railway direction have discussed the renovation of the papal car. Sketches, plans, and other designs have been prepared, and the railway has already had samples of upholstering materials sent to it, for approval, in order to put "the holy car," as it was officially known, in proper condition for Papal use. What the purpose of this renovation is, no one knows except some of the higher Papal and governmental authorities; but it might reasonably be assumed that there is a possibility that the present Pope intends to emerge from his present self-imposed imprisonment and revisit his beloved Venice.

The scheme for cutting a canal between New York and Boston is stated soon to be taken in hand.

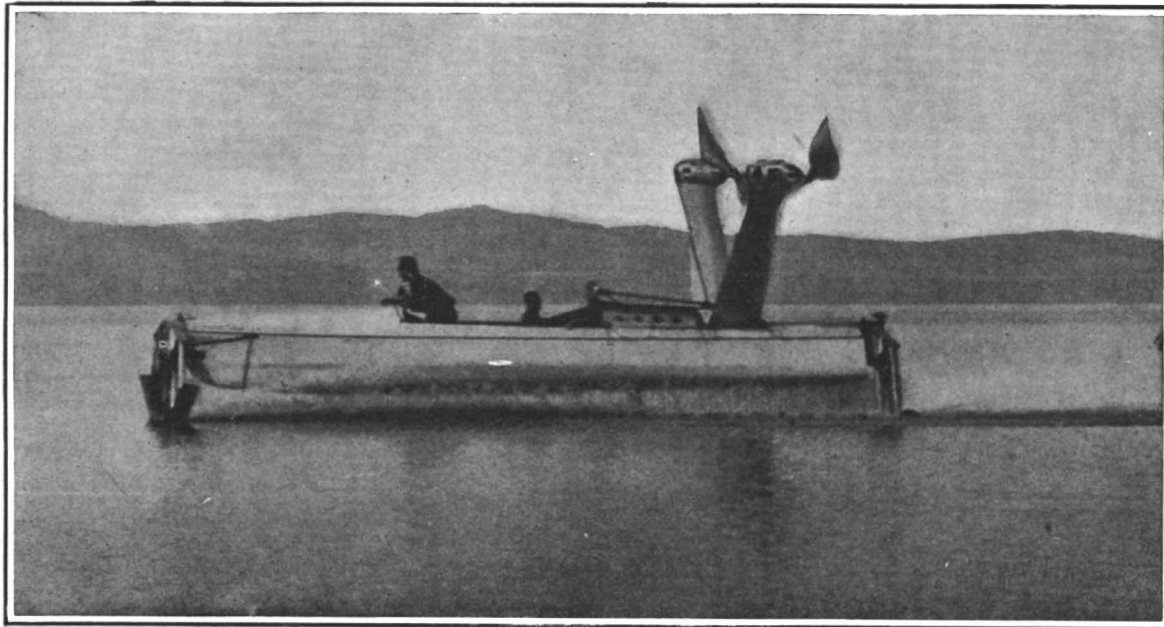

An 80-Horse-Power Hydroplane Boat Driven by Air Propellers.

the V-shaped planes; and at the highest speeds yet attained the hull is, as we have already stated, 18 inches out of the water. It has been found that waves of a height of 20 centimeters (7.87 inches) do not affect the vessel, as at the high speeds the hull stands quite clear of the tops of waves of this size. Trials of a length of 6 kilometers (3.73 miles) have been run, and sharp turns have been taken while running. After a certain amount of further experimental work, the inventors propose to put the boat through still more exhaustive trials, under as varied conditions as possible.

**The Pope's Private Railway Car.**

For many years there stood in the yard of the Florentine railways a saloon car, which bore the name of

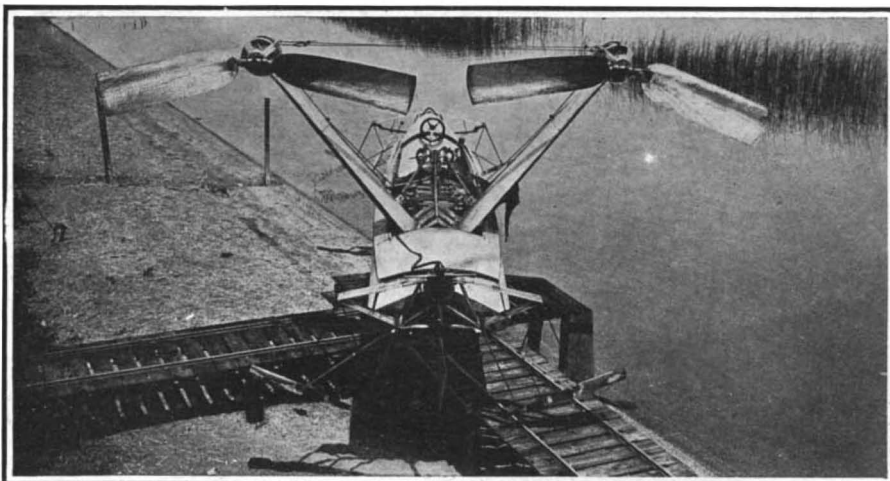

The Propellers Are Mounted on Aluminium Sheeting, and, together with the Shafts, Gear, Transmission, and Controlling Device, Weigh 660 Pounds.

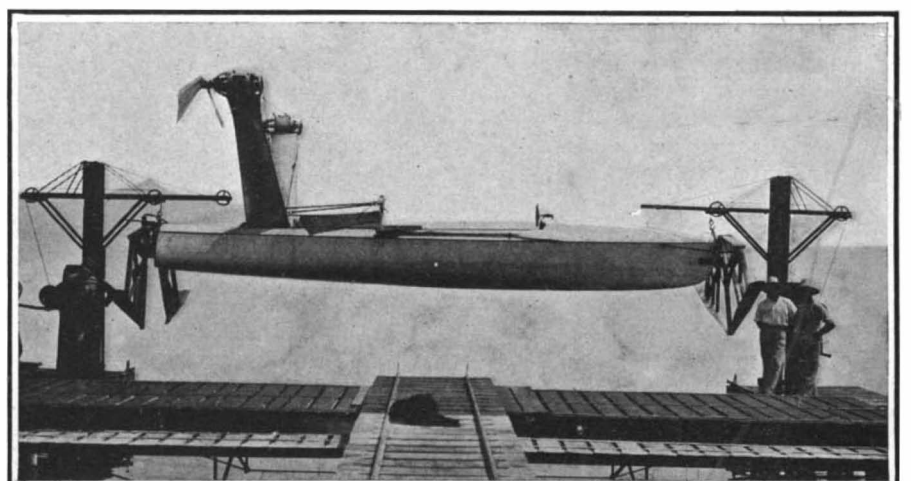

The Planes at the Bow Are Arranged in the Shape of a V; those Aft, Although Similarly Disposed, Do Not Join at the Inverted Apex.

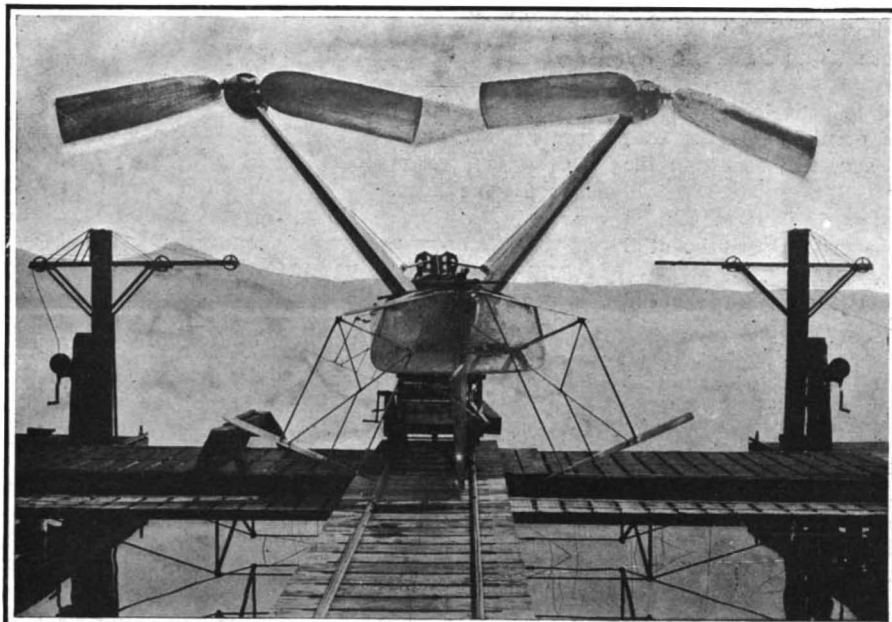

The Stern Planes, Inclined to Each Other, do not Meet as in the Case of the Bow Planes.

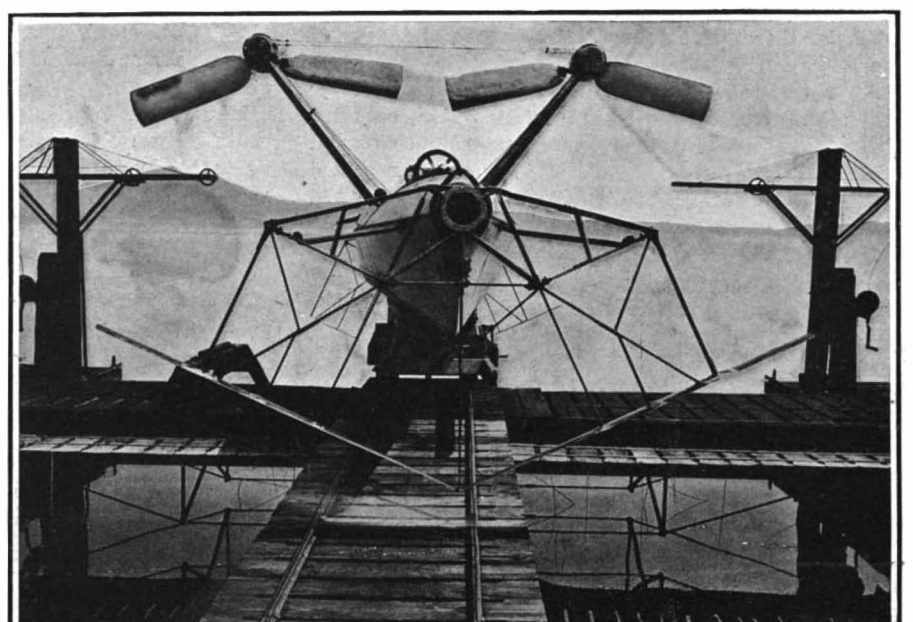

The V-Shaped Planes on Which the Boat is Supported When Running at Full Speed.

**THE CROCCO AND RICALDONI HYDROPLANE BOAT.**

**COMBINED DAM AND POWER PLANT.**

On the Patapsco River there has recently been completed for the Patapsco Electric and Manufacturing Company, of Ellicott City, Md., a combined concrete dam and power house, which is certainly unique among hydraulic-electric plants. The novelty consists in the fact that the power house is built within the dam itself, and lies entirely below the water, which flows above the plant. It is located on the Patapsco River, about 17 miles below Baltimore, on a branch of the Baltimore & Ohio Railroad. The advantages of the arrangement are many, the whole system being very compact, and by virtue of the disposition of its parts, it is conducive to the highest efficiency.

The dam, a cross section of which is shown in one of our engravings, is 220 feet long, 40 feet wide at the base, and its height, from the average level of the water in the tail race to the crest, is 26½ feet. As a protection from floods and to provide suitable entrances to the power house, the buttresses at each end of the dam are carried to a height of 10 feet above the spillway, which is 168 feet in length between the buttresses, and is provided with suitable connections, to which flash boards may be attached, should it at any time be desirable to increase the head of water. The dam consists of a framework of nineteen buttresses, arranged transversely to the axis of the dam, each of which is 24 inches thick at the bottom and 16 inches thick at the top. These buttresses are spaced 12 feet apart center to center. The whole dam is constructed of reinforced concrete, the reinforcing steel being freely used along the edges of the buttresses and of the openings and at the outer faces of the shell. Because of this reinforcement, it was possible to make the outer shell of the dam very light, its thickness varying from 18 inches at the bottom to 10 inches at the top. The apron, on the downstream side of the dam, extends about half way down from the crest, the remaining portion of the structure being left open, exposing the downstream edges of the bulkheads. Between the bulkheads windows are inserted, and these serve for the lighting of the interior power house. The windows are set back a few feet from the lip of the apron, so that the overflow water falls entirely clear of them.

The hollow interior of the dam is provided with a false ceiling of concrete, which is hung some 5 feet from the inner face of the dam, its purpose being to protect the plant from any water which may seep through the outer shell. Such water as finds its way through is carried away by a drain provided for that purpose. The waste water which passes over the dam flows over the apron, until it is within 16 feet of the water passing out through the tail race, and ordinarily the water strikes the bed of the river at a point 20 feet from the downstream side of the dam. At present only about 108 feet of the structure is utilized by the power plant. The chamber in which the apparatus is

control both of the wheels when the generators are being operated in parallel. Each turbine is direct-connected to a three-phase 60-cycle alternator, and each alternator is provided with a 120-volt exciter belted to the shaft. The water is discharged by draft tubes into a well, sunk three feet below the bed of the river, from which it flows out of the dam through a channel constructed in the river bed.

Canada has during the past twelve months built 1,514 miles of new railroads; and in addition has

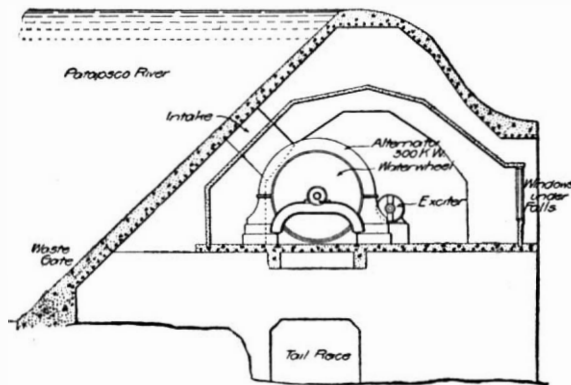

**Cross-Section Through the Dam, Showing the Interior Power House.**

3,011 miles in various stages of construction. The most important undertaking is the building of the Grand Trunk Pacific, the eastern division of which is being built by the government, and the western division by the Grand Trunk itself. The government's division extends from Moncton, N. B., to Winnipeg, a distance of 1,834 miles. Of this mileage 864 are now under construction, but no work has so far been done on the remaining 970 miles. The Canadian government is giving out contracts for the work on this line is working from centers from which access can most readily be had to the

entirely undeveloped country through which much of the new transcontinental line will pass.

The Grand Trunk plans to have about 550 miles of the line west of Winnipeg finished this year, and to complete the entire prairie division running from Winnipeg to Edmonton, a distance of 790 miles, within another year.

One of the most interesting features of the new line lies in the fact that a very low-grade line has been found through the mountains west of Edmonton, Alberta. Describing this part of the line, the London Times, after pointing out that several passes through the mountains were carefully surveyed, says:

"The Yellowhead was eventually chosen, and in November, 1906, the government approved the decision. In this pass the company has obtained a maximum gradient through the mountains, against eastbound traffic, of four-tenths of 1 per cent, or a total rise of 21 feet to the mile for the entire distance. The maximum gradient against westbound traffic, for the entire distance from Edmonton to Prince Rupert, is almost equally favorable with that in the opposite direction. It is no greater than five-tenths of 1 per cent, or a total rise of 26 feet to the mile. In crossing the mountains only one summit is encountered, and the maximum altitude of this is only 3,712 feet. Without going into detail, it is worthy of mention that against this one summit of 3,712 feet encountered by the Grand Trunk Pacific in its passage through the coast mountains there is no other road in America which does not encounter from two to six summits, some of which exceed 8,000 feet in height; and no road has hitherto succeeded in finding a route without encountering a summit of upward of 5,000 feet. The total aggregate ascent overcome against eastbound

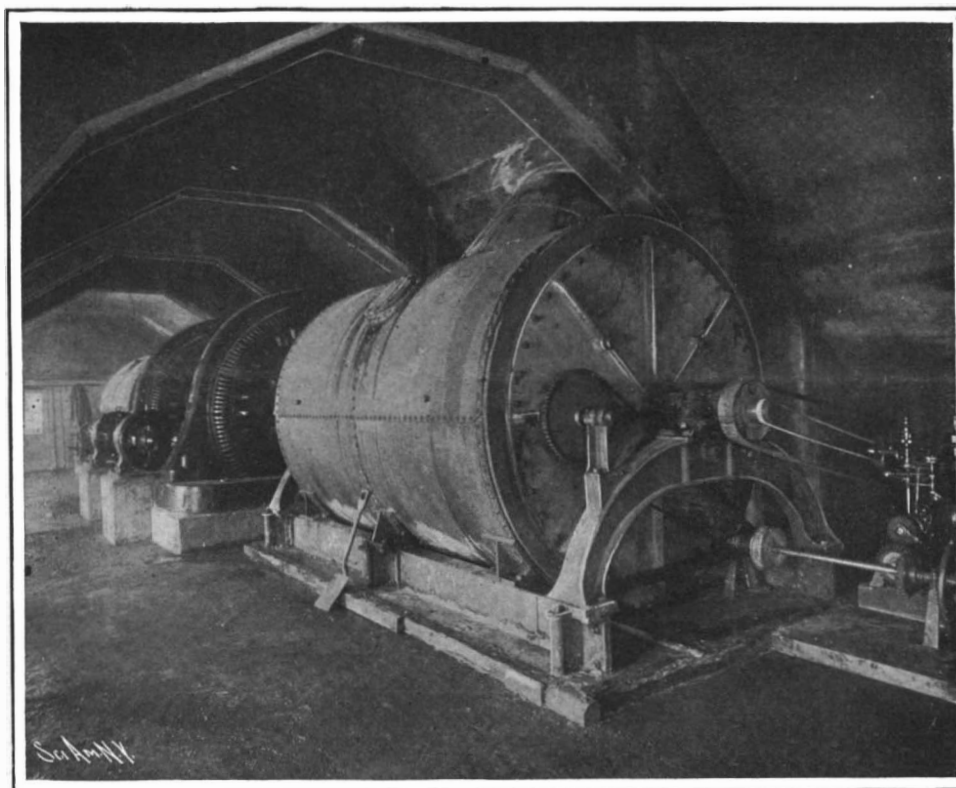

**View in Power Chamber, Showing the Two Waterwheels and Generators.**



**Downstream View of Dam, Showing Windows for Lighting the Power Chamber.**

housed is 10 feet in height and 27 feet in width, except where the buttresses occur, where the width is about 18 feet. The machinery is carried upon a concrete-steel floor, and its arrangement is clearly shown in the accompanying engraving of the interior.

The water is led to two 34-inch horizontal Leffel waterwheels by steel intake tubes, which pass through the upstream face of the dam at the point indicated by our engraving. As the intake is 5½ feet below the crest of the spillway, the racks are kept entirely clear of driftwood and other wreckage. Each waterwheel is fitted with a Woodward governor in such a way that either governor may

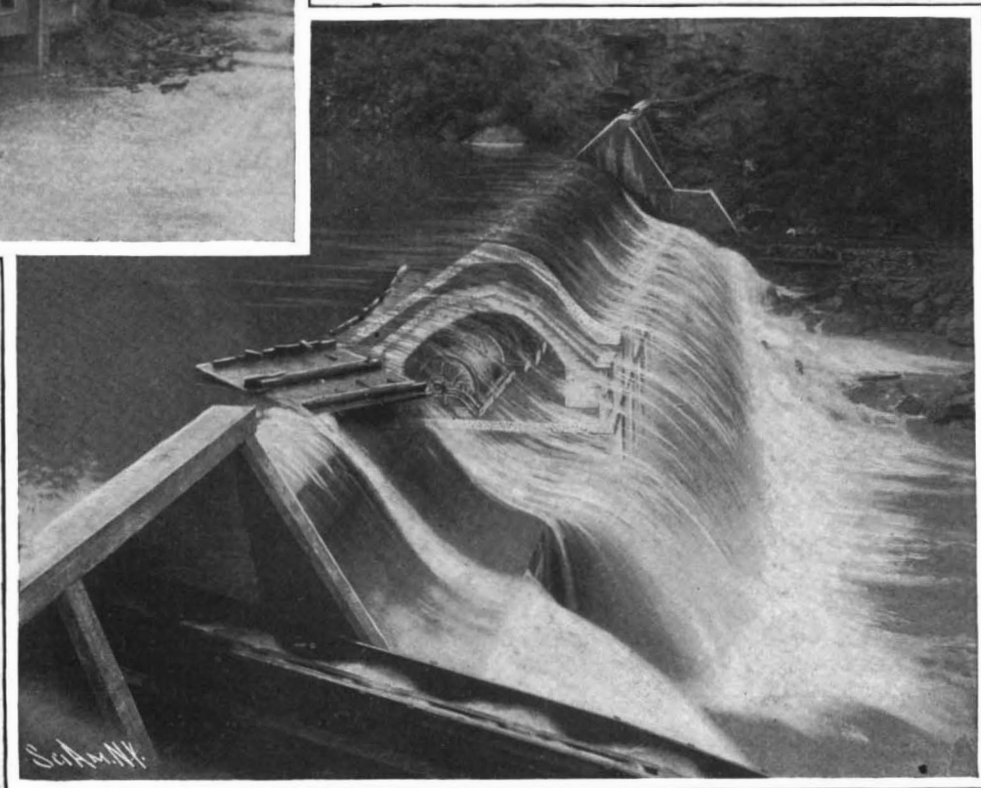

**View Looking Along Axis of Dam, with Portion of Apron Broken Away to Show Position of Waterwheels Within the Dam.**

traffic by the Grand Trunk Pacific is 6,990 feet, that against westbound traffic being 6,890 feet. Other roads have from 15,987 feet to 34,003 feet, and from 15,305 feet to 34,506 feet, respectively. As against the maximum gradients of 21 feet against eastbound traffic and 26 feet against westbound on the Grand Trunk Pacific are gradients of from 106 feet to 237 feet and 105 feet to 185 feet, respectively, on other roads."

For rolling over uneven ground, a land roller is now made in two or more sections, with a flexible connection which yields to the inequality of the ground, a feature which is very desirable for some classes of work. This implement will roll a dead furrow and a back furrow as well as level ground. Another feature is that it has a seat which is adjustable, so that it can be placed behind the rollers, to prevent serious accident in case the driver should be thrown from his seat. The innovation is a welcome one where it is desired to utilize the services of a boy.

**A COMBINED DAM AND POWER PLANT.**

**Scientific Uses of Incense.**

The burning of incense, a practice dating from the remotest antiquity to the present day, is without doubt one of the most remarkable, interesting, and universal customs of mankind.

The popular occidental supposition as to the usage of incense is a most erroneous one. For instance, in the Catholic Church it is considered by many as forming merely a part of the religious ceremony; again, that the Oriental burns incense for no other purpose than to elaborate his idolatrous symbolism.

The origin of this mistaken impression is obvious. According to the anthropomorphism of the devout Oriental, what is good and pleasing to man is likewise good and pleasing to the gods. Therefore, he burned incense to the Deity. The sinuous ascent of the smoke slowly heavenward soon suggested to his poetically florid imagination a visible symbol of the essence of prayer arising to the gods in purification of his soul. This signification finally overshadowed the original purpose—purification of the air and prevention of disease.

On this supposition that the burning of incense was merely an idolatrous practice, the Christian Church was adverse to the custom. Later, upon learning of its real purpose, its use was incorporated into the service. It was thus used in the churches as a deodorant in the time of Charlemagne, if we may believe the quotation from the "Benediction of Incense" given by Martene: "May the Lord bless this incense to the extinction of every noxious smell."

The mention of incense in the records of the ancients is interesting. In the Old Testament we find its use made a part of Mosaic legislation. Aaron burned it when he offered a sacrifice for the sins of the people. (Num. xvii, 11-12.) A formula for incense is given in Ex. xxx, 34-38, naming four ingredients. Tradition adds seven more, and Josephus states that it contained thirteen; one a secret herb that caused the smoke to rise in the form of a date palm, and known only to the family of Ablinas.

In the remote year of 2500 B. C., Pharaoh Sankhara sent Hannu, an Egyptian nobleman, at the head of a naval expedition to the holy land of Punt to obtain the odoriferous gums used in the preparation of incense. "Punt," now authentically identified with modern Somali, Africa, still produces these precious ingredients. Incense was used by both the Greeks and Romans from their earliest times for the purpose of deodorization in their temples and places of public congregation. Representation of the censer and its ornamental tripod with the graceful, curling smoke of the incense gained a place in their art. Mention is made of incense in the ancient and sacred Zend Avesta of the Zoroastrians and in the cuneiform of Nineveh and Babylon. To-day it is used throughout India in the form of "ud-butā" (benzoin light) and it is authoritatively stated that incense was anciently introduced into China and Japan by the Brahmans.

In consideration of the fact that incense, as a deodorant and preventive of disease, has been used successfully in the Orient for thousands of years, it would seem strange that it has received so little attention in the West, where science has made the general public fully aware of the dangers of infection. True, modern chemistry has produced many powerful, efficacious disinfectants, but all have the objection of offensive smells that render them unsuited for use in the home. The burning of incense containing sandalwood and frankincense releases volatile oils that act as mild but perfect disinfectants and deodorants for the home, yet at the same time permeating the air with a delightfully soothing perfume.

Apart from its religious signification, incense is now universally used in the Orient as a deodorant and purificant of the air in temples, public buildings, and residences. The cleanly Japanese, who removes his shoes before entering the home to prevent the introduction of infection, has grown remarkably proficient in the preparation and use of incense. It would, therefore, seem that the Occidental who does not even take this precaution should at least avail himself of the pleasant preventive as used by the cleanly Jap.

Arctic exploration is as fascinating to-day as in the days of Frobisher or Hudson. The Pole itself still preserves its secret, and the lure of fame tempts many men to endeavor to solve it. Several of the suggested methods of progression show the wide change of plan since the days when whaling ships endeavored to force their blunt bows through the ice. An expedition is projected in which dog-sleds will be superseded by an amphibious automobile boat, designed to travel either on land or water. Mr. Wellman still expects to achieve success through his balloon; and Capt. Amundsen proposes to utilize a team of polar bears. In addition to these, Dr. Cook, at Etah, is awaiting a favorable moment for a dash northward. Robert E. Peary and E. V. Baldwin both expect to start again; and similar word comes from Capt. Joseph E. Bernier of the Canadian exploring expedition, who is at present returning from a journey in the far North.

**The British Patent Act Amendment.**

In 1902 the British Patent Act was amended to provide for a limited examination concerning the novelty of the subject matter of patent applications, to make provision for the grant of compulsory licenses when patentees failed to commence the manufacture of the patented invention in Great Britain, and, in certain cases, to revoke patents because of non-manufacture when the grant of licenses would not satisfy the demands of the British trade. These amendments have now been the law of Great Britain for five years, during which time they have been carefully construed, with the result that further amendments have been suggested to carry into effect the changes which Parliament had in mind when the previous amendatory act was passed, and to introduce new features in the British Patent Act, the need of which has been impressed on practitioners in the prosecution of patent applications under the amendment of 1902.

As it is possible in Great Britain to file a provisional patent application before the details of the complete device have been worked out, inventors often proceed in that way, and, within six months, complete the case by filing papers in which the invention is precisely defined and claimed. When, in his experiments, the inventor finds that such material changes are advisable as to enlarge the inventive act, it is necessary for him to file a second application, as he would endanger the validity of his patent by attempting to include the newly-invented features when the first application is completed. This limitation has suggested three of the amendatory provisions which will be found in the new law. It is provided that where two or more provisional applications are filed on inventions which are cognate or modifications one of the other, the applicant may, with the consent of the Comptroller, file one complete application embodying the features of the several provisional cases. The applicant may also file papers completing a provisional application, with the assurance that if the Comptroller should decide that new inventive matter is included which is not mentioned in the provisional papers, he may post-date his application as of the date of the filing of his complete papers, or he may file a divisional application on the new features bearing the date of the filing of the complete papers, and permit his first application to proceed with the features which are common to the provisional and complete papers. Should it be held that the Comptroller has erred in permitting an applicant to include in his complete application features which are not mentioned in the provisional papers, under the amendment, the validity of the patent cannot be attacked on that ground. Provision is also made for the grant of patents of addition, which are exempt from the payment of taxes, carrying out the policy indicated in reference to completing provisional applications.

The Comptroller is authorized to refuse to grant a patent when the invention claimed is wholly and specifically claimed in any specification to which the examination has extended.

Among the other important sections in the amendment are found provisions which authorize the Comptroller to restore patents which have become void because of the non-payment of prescribed fees, and which authorize the sealing of patents after the expiration of the period prescribed in the principal act.

To the previous amendments, in reference to the manufacture of the patented invention in Great Britain, has been added a section authorizing the Comptroller, after the fourth year of the term of a patent, to revoke patents where it is shown that the manufacture is carried on exclusively or mainly outside of the United Kingdom; but from the wording of the law it is evident that this remedy for the non-manufacture in Great Britain is only to be relied on in extreme cases. The decision of the Comptroller is subject to review by the court.

On the whole, the amendment is in the interest of inventors, and it should encourage them to take advantage of the opportunity to protect their inventions in that great industrial and social field embraced within the limits of Great Britain. The new act will go into effect on January 1, 1908.

**Copyrights.**

During the twelve months ending June 30, 1907, 123,829 entries for copyright were made at Washington. These included not only books and magazines, but photographs, newspaper articles, musical and dramatic compositions, and other items. More than 31,000 musical compositions were entered; rather more than a quarter of the sum total. Of books, 16,651 were entered, and 16,672 photographs. The office received \$84,685 in fees. According to law, two copies of a copyrighted article are delivered to the Registrar of Copyrights, to be filed in the Library of Congress.

On October 15 two aeronauts ascended from Bordeaux in France, and no trace of men or balloon has been found. It is supposed the balloon drifted out to sea. A short time ago a British military balloon was similarly lost.

**Aeronautical Notes.**

That the United States has not overlooked the possibilities of military ballooning is evidenced by the fact that one was in use in the Spanish-American war. For some time the authorities have been content to watch the experiments of other powers, but it is probable that soon an appropriation will be made for constructing a large dirigible balloon. An aerostatic corps has recently been organized by the army signal service corps, under the command of Capt. Charles De F. Chandler. It is proposed to locate army balloon headquarters at Fort Omaha, and a contract has been placed for a plant there to supply hydrogen for the army balloons. This will be shipped compressed in cylinders to various points, where balloon drills will be held. It is probable that a second station will be built, on or near the Atlantic coast, and a third one near San Francisco.

A report that Count Zeppelin's airship has been sold to the German government is denied by the Count himself. He states, however, that the balloon shed has been sold to the government, to be used as a harbor for military airships. Other harbors will be constructed at Kiel and Strasburg, and it is reported that the German government has commissioned Count Zeppelin to build an airship capable of carrying 18 passengers and having motors of 285 horse-power.

Dr. Alexander Graham Bell, who is experimenting in aviation at his country home in Nova Scotia, has completed a machine built on the plan of a kite, and expects to test it in a few days. He says: "We are nearly ready to put a large machine into the air, and it is possible that within the next week or so we may fly the machine as a kite, with a sandbag the weight of a man. If the experiment is successful we shall place a man in the machine without a motor and allow him to glide down to the water from an elevation. I think it wiser to begin by raising him into the air in the machine blown as a kite and towed by motor."

On the 25th ult., after witnessing some maneuvers of Gross and Parseval airships, Kaiser Wilhelm is said to have remarked that he was very hopeful of the future in aerial navigation and that he has a firm belief that there will be further successes in this line. The Germans have advanced to the stage where they now have special field guns for shooting directly upward at balloons or airships.

The German Emperor's optimistic view of aeronautical matters augurs well for the success of the Wright brothers in disposing of their aeroplane to the German government. Our own government should take steps immediately to forestall any foreign nation getting this invention. Now that the usefulness of airships and aeroplanes is coming to be realized by our military authorities, they should make every effort to secure for our government the only aeroplane that is known to have made a long-distance flight anywhere throughout the world.

Cable reports from Paris record the fact that on the 25th ult. Mr. Henry Farman made more than fifteen flights across the military parade ground at Issy les Moulinaux. These flights ranged from 100 to 300 meters (328 to 984 feet) in length, and it is estimated that the machine rose to a height of from 10 to 12 meters (32 to 40 feet). The machine rose readily and seemed to be under good control. It also alighted without shock and without any damage being done to it.

**Japanese Vegetable Milk.**

In a recent number of a Japanese journal a Mr. T. Kalajama described a process for the manufacture of a vegetable milk, the properties of which would render it highly suitable for use in tropical countries. The preparation is obtained from a well-known member of the leguminous family of plants (namely, the Soja bean), which is a very popular article of food among the Chinese. The beans are first of all softened by soaking, and are then pressed and boiled in water. The resultant liquid is exactly similar to cows' milk in appearance, but it is entirely different in its composition. This Soja bean-milk contains 92.5 per cent water, 3.02 per cent proteine, 2.13 per cent fat, 0.03 per cent fiber, 1.88 per cent non-nitrogenous substances, and 0.41 per cent ash. Kalajama added some sugar and a little phosphate of potassium (in order to prevent the elimination of the albumen) and then boiled the mixture down, till a substance like condensed milk was obtained; this "condensed vegetable milk" is of a yellowish color and has a very pleasant taste, hardly to be distinguished from that of real cows' milk. However, it still retains the aroma of the Soja bean. It is recommended as a cheap and good substitute for condensed cows' milk.

It is stated that a company has been formed to develop the rich asbestos deposits of the Minoussinsky district in Siberia. The deposits, it is said, are easy to operate, and are situated in an inhabited region, and only about eight miles from the Yenissei River. This will be the first exploitation of asbestos in Siberia.

**Correspondence.**

**Evolution of the Barbed-Wire Fence.**

To the Editor of the SCIENTIFIC AMERICAN:

In regard to the evolution of barbed-wire fence, I would state in the year 1861, while a boy of ten summers, I was riding in a new section with my father; and noticing a new kind of fence to me, asked my father why the fence was made that way, with one board at the top and one board at the bottom, leaving a space about two feet wide, with two wires stretched at equal distance in the space, from post to post. My father said that the snow drifted very hard along there, and thus the wires would let the wind blow through, and not leave an eddy for the snow to drift. I said: "Father, let's build such a fence in front of our place, so you will not have so much snow to shovel." Father said: "All right." After a while, father drove the posts and put on most of the boards. I drove some nails and put on the wire; the wire was put on tight, so it would stay in place. All was well until the next spring, when every wire was broken. Needing counsel again, I asked father why the wires broke. He explained expansion and contraction. Having more of the same kind of wire, I doubled the wires and twisted them, and put them on again, and was ready for another winter. Meanwhile there were neighbors who let their hogs run in the highway. The hogs got a notion of jumping through, between the lower board and wire, and destroying our garden. Being determined to keep the hogs out, I proceeded with my wire pliers and pieces of wire; inserted the pieces between the twisted wires, and wound the pieces around one of the long wires, putting the pieces or barbs in about six inches apart, and cutting the ends off, leaving them as sharp as I could, with the pliers. The hogs got through a few times after the barbs were put in. However, the barbs had the desired effect, as the owner saw his hogs were getting terribly marked, and kept them at home. The above-described fence stood beside a public highway for about fifteen years, and did good service.

ADRIAN C. LATTA.

Friendship, N. Y.

**Telegraph vs. Telephone for Train Dispatching.**

To the Editor of the SCIENTIFIC AMERICAN:

Referring to the article by E. J. Burke, president of the Blake Signal and Manufacturing Company, on Telephone vs. Telegraph Train Orders, in your issue of October 12, I wish to state I do not agree with the method he advances for the dispatching of trains by the use of the telephone. Telephony as it is to-day is impractical as a means for dispatching trains.

It is plain to one who has had experience in rail-roading and railroad telegraphy, that the telephone has no advantages over the telegraph, and the disadvantages are more in evidence. Among which are the following:

The telephone is a slower method of transmitting an order or message than the telegraph, notwithstanding Mr. Burke's statement to the contrary. It is true that the dispatcher or operator could speak an order or message faster into a telephone transmitter than he could send it by telegraph; but as it is necessary that this be copied at the receiving end, it would be useless to talk at a faster rate than the recipient could copy; besides, it requires a good penman to write thirty words a minute and at the same time make an intelligible copy, such as is necessary.

Owing to the inability of the telephone at times to transmit sounds perfectly, many words which sound similar could be easily misunderstood, and even when spelled out could also be misunderstood because of the likeness in sounds of letters, such as *a, j, k* and *d, e, b*, etc. With these disadvantages alone, it would be impossible to copy correctly at this rate.

It has been advanced that the telegraph operator is as liable to mistakes as the telephone operator, but we should remember that the former has spent years qualifying himself in the art of distinguishing sounds, while the conductor has not.

Atmospheric disturbances and general line interferences are other disadvantages which would also be encountered.

We must not lose sight of the fact that the telegraph operator is of necessity a more rapid and better copier than the conductor, owing to the nature of the work of the latter, and hence this would result in adding to the loss of time.

We have yet to consider the impracticability of the telephone method for double-track work, in that it would be impossible for trains "on the run" to receive orders or messages. This stopping of trains to allow the conductor to receive telephonic instructions, would cause unnecessary congestion of traffic.

Another objection is the difficulty sometimes encountered in starting trains owing to certain weather and grade conditions, which result in further delay.

If we substitute the telephone for the telegraph, we would find it almost impossible for station agents, operators, or others, whose duties require them to be

well posted on the movements of all trains, to furnish information regarding same to those requiring it.

With the telegraph, when one operator reports to the dispatcher the "arrival," "departing," or "by" time of a train at his station or tower, all other operators may be cognizant of the fact; while with the telephone it would be practically impossible unless the operators kept the telephone receivers or "lugs" constantly to their ears. This would, of course, be out of the question.

As thirty words a minute is only an average working speed of a telegraph line, while with the telephone it has been shown that it is impossible for that number of words to be correctly copied, therefore for this reason, and others presented, I can plainly see that the telegraph is a much quicker and safer medium or method of dispatching trains than the telephone.

R. H. SAWLER, Principal,  
Boston Telegraph Institute.

Boston, Mass., October 17, 1907.

**A Quadruple Meteor.**

To the Editor of the SCIENTIFIC AMERICAN:

The accompanying illustration shows very accurately a strange meteor which fell near Angelica, October 1, 1907. The balls of fire traveled rapidly in an oblique course, and when near the ground turned red and



A QUADRUPLE METEOR.

then disappeared. Since these remained a uniform distance apart, they seem to have been connected.

Niagara Falls, N. Y.

JOHN W. HOGUE.

**Telephone vs. Telegraph Transmission of Train Orders.**

To the Editor of the SCIENTIFIC AMERICAN:

I have read with much interest the articles written by F. H. Sidney and E. J. Burke as to the relative merits of the telephone and telegraph for the transmission of train orders. I would like to take exceptions to some of the statements made by Mr. Burke.

If the telephone is a safer, better, and quicker method of handling train orders, why have several of our leading railroads that have tried the system returned to the telegraph?

One drawback to the telephone is the ease with which a light electrical storm can put it out of commission; while such a storm does not affect the telegraph at all.

As regards time, the plan for the conductor to go to a booth, answer a call, copy the order, repeat it to the dispatcher and get his O. K., and wait for the engineer to go through about the same performance, is impractical for two reasons:

1. It would consume entirely too much time.
2. The order given may affect one or a dozen trains, opposing the train for which the conductor in question receives the order; and according to standard rules, if his train is inferior to the opposing trains, all the conductors of opposing trains must repeat their orders before this one could get his order completed.

The time required for this would vary in proportion to the number of opposing trains, which in itself would be prohibitive; while with the telegraph, as a usual thing, the orders are always ready for the conductor's signature upon arrival of his train, and can be delivered within one minute, if it be a "31" order, after his arrival; but if it be a "19" order, it would be delivered to the engineer and conductor without stopping or even slowing down his train.

Again, when an order is given simultaneously to one or more offices, the order has to be repeated to the dispatcher, who with all offices addressed must check the order as repeated, thereby placing several checks against the possibility of an error in receipt of order, which could not be done by the telephone system.

As to the telegraph being slow, and cumbersome in the transmission of messages, it is just the reverse. Let Mr. Burke take his pencil and write from thirty to thirty-five words per minute from dictation, as this is the usual rate of transmission by dispatchers, and see if there is anything slow about it. How much faster would a conductor copy an order from a telephone?

How many conductors could copy a legible order at twenty-five or even twenty words per minute?

And I will say there are no words left out of an order that would give a better understanding of it. Now, I am an ordinary railroad telegrapher, not an expert, and still not a "ham," and my duties require me to copy a great many messages from our local 'phone. Therefore I feel competent to say that, of the two, the telegraph is much faster, more easily copied, and far less liable to error than the telephone; and anyone who has had any experience in copying from a 'phone knows how often it is almost impossible to distinguish separated letters and sometimes whole words; many times having to ask three or four times before getting it correctly, while the telegraph is ordinarily plain as print.

Of course, occasionally we find a telegrapher who does not transmit plainly, just as we find persons who do not talk or write plainly; but they are exceptions.

The simple fact that the railroads of this country are not using the telephone for train dispatching, seems to me to be conclusive proof that the telegraph is a better, safer, and quicker means of communication than the telephone.

O. C. KNIGHT, Telegrapher.

Peebles, Ohio, October 13, 1907.

**Longitudinal Sleepers.**

To the Editor of the SCIENTIFIC AMERICAN:

Kindly allow me to point out that the suggestions made by Mr. A. J. Allen in the SCIENTIFIC AMERICAN of the 21st ultimo in respect to the construction of railroads are very far from being new or original. What are known as "longitudinal sleepers" were in use on the Great Western Railway (of England) from the earliest days of its existence to the time of its conversion, some fifteen years ago, from the Brunel gage to the standard (4 feet 8½ inches) gage; in all, about fifty years.

The engineers of that line evidently had good reasons for doing away with the longitudinal sleepers and adopting instead cross-ties, or they would hardly have gone to the trouble—involving great inconvenience and expense—of taking up and relaying several hundreds of miles of railroad track. But this is what was done.

I am told that the great objection to the longitudinal sleeper is that the heavy locomotives used nowadays on passing onto a sleeper tilt it up at the opposite end, thus not only increasing the amount of resistance to be overcome and consequently lessening the relative power of the engine, but also making the upkeep of the track more expensive.

I know from experience that the old Great Western broad-gage trains running over longitudinal sleepers were far more comfortable than the narrow-gage trains running over cross-ties are; but how far this might be due to their breadth or to the sleepers, and how far it might be advisable to adopt the longitudinal sleeper on American lines, where the "overhang" of the car is greater than on English ones, I do not know.

T. C. L.  
Southport, England, October 2, 1907.

**The Current Supplement.**

The effect of burning coal gas on the air of our dwelling rooms, and the health of the occupants, is as old a subject as the use of coal gas itself. Still, Prof. Vivian B. Lewes, a well-known British gas engineer, throws a wonderful amount of new light upon the subject in an admirable article published in the current SUPPLEMENT, No. 1661. The products and the amount of the products obtained from the distillation of soft wood are enumerated. Mr. J. H. Morrison contributes two articles, the one being the tenth installment of his treatise, "The Development of Armored War Vessels," and the other discussing Robert Fulton and the sidewheel steamboat. The most important technical article of the paper is one on floating cranes, in which the more important types are illustrated and described by diagrams and photographs. C. Vickers writes on the many methods of making solid copper castings. "Iron Hands" is the title of an article which gives much curious information. Hector Macpherson writes on the distribution of the stars.

**Large Quarry Blast.**

One of the largest blasts ever fired in France was discharged recently at the quartzite quarries at Cherbourg, and is said to have displaced 120,000 tons of stone. A tunnel measuring 6 feet wide and 6 feet high was driven into the face of the cliff for a distance of 70 feet, and at its end two branch tunnels, each 20 feet long, were driven to the right and left respectively. These branches ended in chambers 40 feet apart and 70 feet from the face of the cliff, and measuring each 10 feet by 6 feet by 6 feet. The chambers were charged with 8½ tons of blasting powder and 280 pounds of dynamite, and the blast was fired electrically. The quartzite obtained from this quarry finds much favor in England as a road material.

**THE LONG DISTANCE BALLOON RACES FROM ST. LOUIS.**

In 1906 Mr. James Gordon Bennett offered a cup for international aeronautic races. The first contest started from Paris, and resulted in Lieut. Lahm's bringing the cup to this country to be held against challengers, by the Aero Club of America. This year six balloons were brought over from Europe in an endeavor to win back the trophy—three of them from Germany, two from France, and one from England; for the defense three American balloons were entered. The contest is for distance, and the rules stipulate that balloons shall not exceed 77,000 cubic feet, with an excess allowance of 5 per cent, or a gross allowance of about 80,000 feet. Eight of the nine balloons entered were near the capacity limit, ranging from 75,000 to 79,500 cubic feet. Although motor-driven balloons are allowed, none competed in the race; the competitors all depended on finding an air current to drift them.

The one great fear of balloonists is the sea. European aeronauts, who may soon drift beyond the coast from any point in France or England, highly approved the choice of St. Louis as the starting place of the great race. A general impression prevailed that southerly winds would be encountered, which would drive them toward the Great Lakes. The fact that there was a shore beyond, which might be reached by balloons crossing the lakes, and that the lakes themselves swarm with shipping, allayed any undue fear of a northerly course. As the event proved, it was the sea, after all, that proved the determining factor of the race.

In a balloon race the home aeronauts have no advantage over their visitors, beyond that of a possibly better acquaintance with the set of air currents; in this instance every help was rendered the visitors, with maps and other available information, and the nine balloons started on practically equal terms.

More than a hundred thousand persons collected in Forest Park, St. Louis, on October 21, to watch the start of the great race. The gas last from the main is the lightest, but simultaneous inflation prevented any balloon from obtaining an advantage in this respect. At a few seconds after 4 o'clock the German balloon, the "Pommern," under the command of Oscar Erbloch, ascended, followed five minutes later by Major Hersey in the balloon "United States." At 4:40 the last of the competitors cast off.

Each balloon carried two persons, the pilot and an assistant. They were all muffled against cold, and prepared to face a hard journey. Little sleep is possible on a long voyage, and intense cold may be met with, while the inflammable gas above them forbids any fire where with to warm themselves. Each balloon carried, in addition to provisions, a number of recording instruments. These equipments varied, but in general included a compass, a self-registering aneroid barometer, a statoscope which registers the rise and fall of a balloon, wet and dry thermometers, charts, and small electric flashlights for reading the instruments and charts at night. The basket-cars



Attaching the American Flag to the "United States."

were lined or hung with cork, for safety in case a balloon should fall in the water. Fortunately, no disaster of this kind occurred, nor did any aeronaut find it necessary to throw over his instruments or cut his

being seen were received from many sources; they suggested that the balloons had drifted for some distance at varying heights in search for a steady current, and had finally settled down to an easterly course. Next day the easterly course was confirmed; eight balloons were reported crossing Indiana and Ohio, apparently headed direct for the Atlantic. At nightfall on October 22 Major Hersey in the "United States" landed on the shores of Lake Ontario, 650 miles in a direct line from St. Louis. With the exception of the single English balloon competing, which soon came to the ground owing to the sickness of the assistant, this flight of Major Hersey's was the shortest one. But it is worthy of note on account of its direction. Major Hersey was the one competitor who has made a close study of air currents in this country, and he was the one man who was able to find and hold the northeasterly course which the aeronauts expected to follow. Handicapped with a leaking balloon, and with his ballast almost exhausted, he was forced to descend on seeing Lake Ontario before him. Had his equipment been sound, and had he been able to hold the current, he could have traveled hundreds of miles before reaching the Atlantic.

On the morning of October 23 the balloons began to drop, along the Atlantic coast. Early in the day the German balloon, the "Pommern," descended on the shore at Asbury Park, in New Jersey. A few hours later the French competitor, "L'Isle de France," came down close to the same spot; farther south the "Duesseldorf," another German competitor, stopped on the banks of Delaware Bay. Four other contestants halted farther south before crossing Chesapeake Bay.

When the distances came to be measured, the "Pommern," piloted by Oscar Erbloch, was adjudged the winner, having covered a distance of 876 1/4 miles. This takes the trophy to Germany, where the next race for it will be held. In addition to the trophy the successful aeronaut receives \$2,500 and half the entry fees.

The second balloon was "L'Isle de France," piloted by A. Le Blanc, which traveled 870 1/4 miles. Either of these balloons could have traveled for many hours before being exhausted, and the German owes its victory to the accident of being a mile or two farther north than its competitor, where the coast runs in an easterly direction. M. Le Blanc has some consolation, however. He was in the

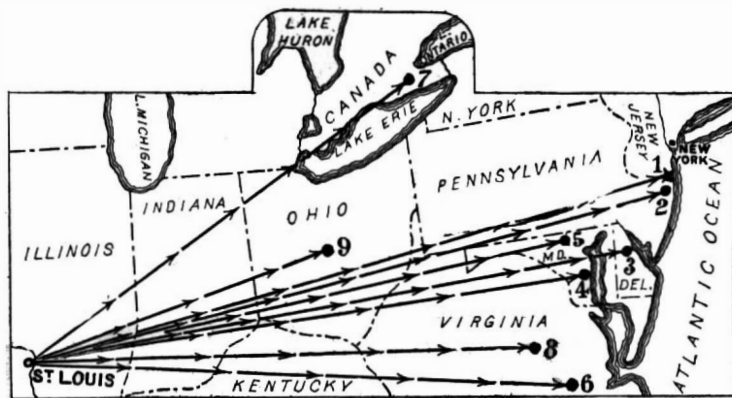

The Finish of the Race.

1. The Pommern. 2. L'Isle de France. 3. The Duesseldorf. 4. The St. Louis. 5. The America. 6. The Abercron. 7. The United States. 8. The Anjou. 9. The Lotus II.

car loose, as he was allowed to do by the rules. The gas supplied was of exceptional quality, and no balloon came down as a result of exhausted supply.

On the evening of October 21 reports of balloons

and the German owes its victory to the accident of being a mile or two farther north than its competitor, where the coast runs in an easterly direction. M. Le Blanc has some consolation, however. He was in the air for 44 hours 2 minutes, and so established a world's record for duration of flight; the previous best being 35 hours 40 minutes, made by Count de la Vaulx in his flight from France to Russia, when he made a world's record, for distance, of 1,193 miles.

The distances covered are given by the authorities of the Geological Survey, and though they will be passed on by an expert, it seems certain that Herr Erbloch will be confirmed as the winner. These measurements are made in a direct line between the starting and alighting posts. As balloons seldom travel in a straight line, they do not represent the actual mileage covered. In this connection it is interesting to note that a long-established

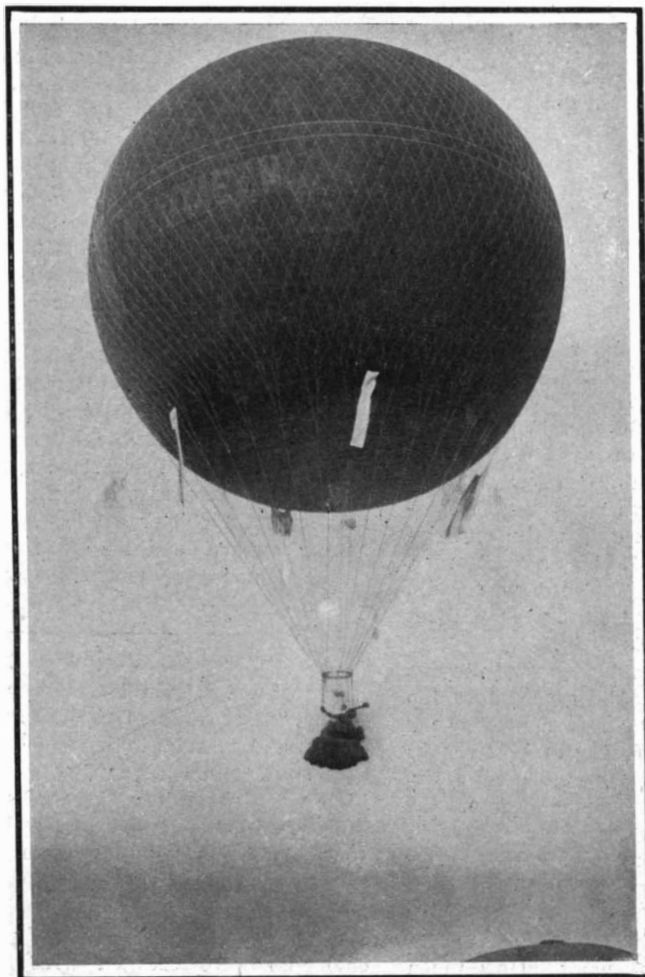

The "Pommern"; the Winner of the Gordon Bennett Cup.

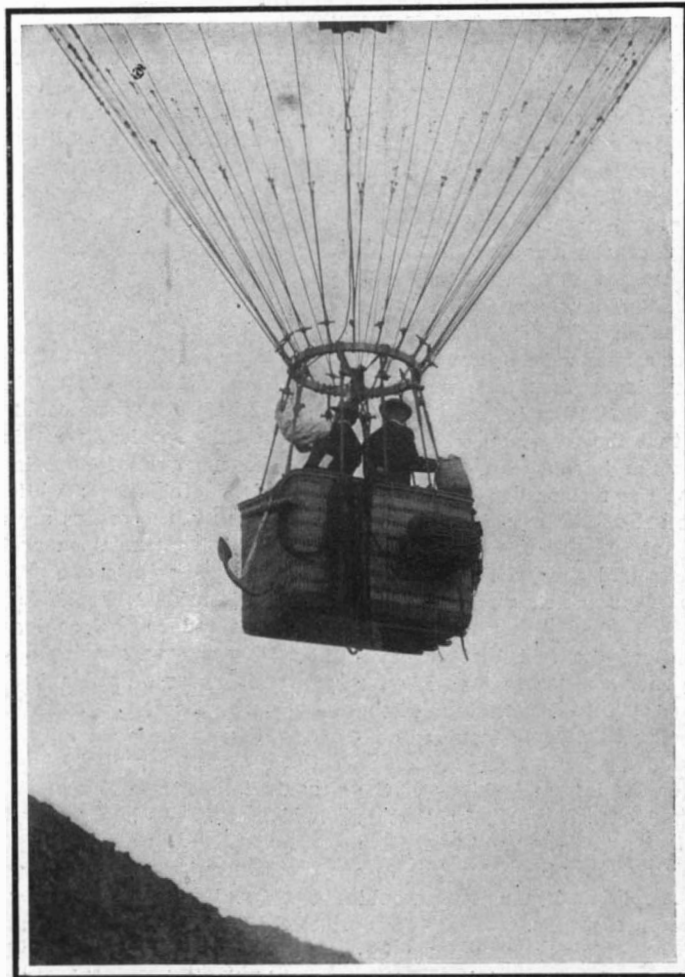

Capt. Chandler and J. C. McCoy in Their Voyage for the Lahm Cup.

**THE LONG DISTANCE BALLOON RACES FROM ST. LOUIS.**



lished American record has been doubly defeated, though by the narrowest of margins. In 1859 John Wise traveled a distance of 1,150 miles from St. Louis to Henderson, N. Y. This record has frequently been quoted as a world's best, and it almost equals Count de la Vaulx's record of 1,193 miles. But by modern methods of measurement the distance traversed by Wise was only 870 miles.

A few days before the international race, a voyage was undertaken by two men who later competed for the Gordon Bennett trophy. On October 17 Capt. De Forest Chandler and J. C. McCoy ascended from St. Louis in the United States Signal Corps balloon No. 10, capacity 78,000 cubic feet, in an attempt to win the Lahm cup. This they succeeded in doing, landing 3 miles from Walton, W. Va., on October 19, a direct distance of 475 miles from St. Louis. The voyage commenced at 4:10 P. M. on the 17th, and the aeronauts landed at 1:30 A. M. on the 19th. The journey therefore lasted 20 hours 15 minutes, and the net speed was 24 miles per hour.

The Lahm cup is named in honor of Lieut. Lahm, who won last year's race for the Gordon Bennett trophy. On that occasion he traveled from Paris to the north of England, a distance of 402 miles. As in this year's race, the sea stopped the leading balloons before their carrying power was exhausted, and Lieut. Lahm owed his victory to a careful judgment of the altitudes at which the most favorable air currents would be met. On the news of the victory, the Aero Club of America showed their appreciation by offering the Lahm trophy, to be held under certain conditions by members of the Aero Club, who make flights exceeding 402 miles.

One of the illustrations on our front page shows Lincoln Beachey making the flight for the cash prize of \$2,000, which was offered by the Aero Club of St. Louis for a competition of dirigible balloons. The contest was held subsequently to the International balloon race on the 23rd ult. Beachey's opponents were Capt. Thomas S. Baldwin, in his new California "Arrow," and Jack Dallas in another Strobel airship similar

to that piloted by Beachey. Both Dallas and Beachey's airships are the property of Charles S. Strobel, who has been exhibiting them at various fairs and other amusement places. Both airships are of about the same size.

At the time the competition was started there was a rather strong and gusty wind, which completely turned around Baldwin's and Dallas's airships, although the pilots succeeded in driving them once more into the wind, and in finally completing the course at a very low rate of speed. When Beachey made his flight, it was later in the afternoon and the wind had died out. Starting from the grounds of the Aero Club, he drove his airship out and around the Blair monument and back to the grounds, over a course which was estimated to be about three-quarters of a mile, in 4 minutes and 40 seconds, which is equivalent to a speed of about 9.64 miles an hour. He subsequently made another circuit of the course in 6 minutes. Apparently, he was traveling at a quite rapid gait, although, in reality, the speed, as can be seen, was not high.



The Connection Between the Balloon and the Gas Main.

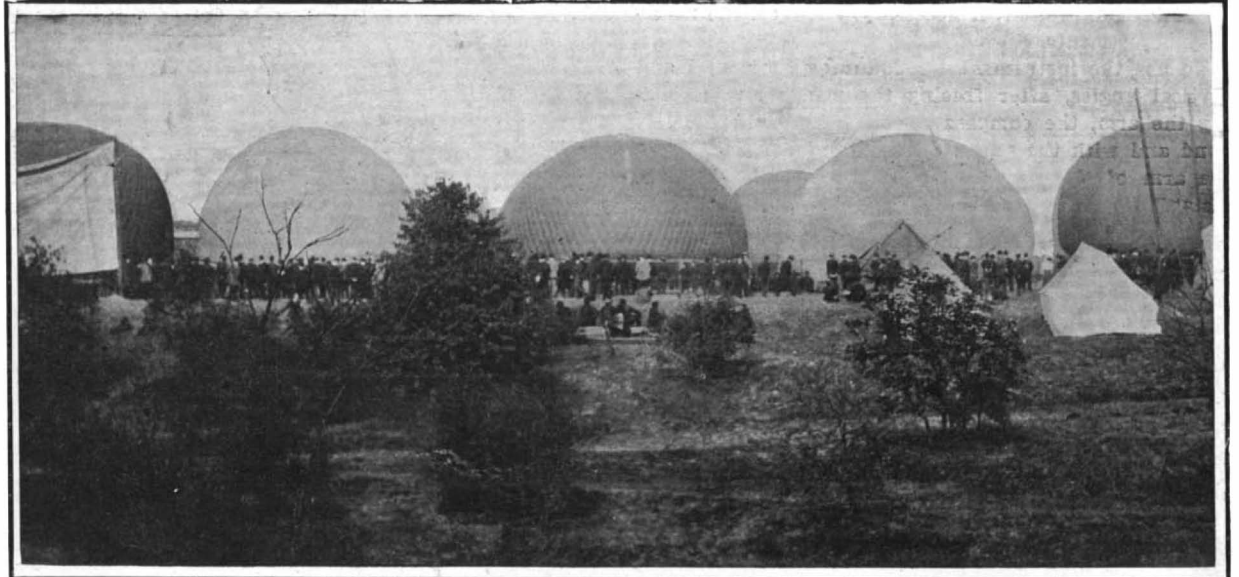

Simultaneously Inflating the Nine Balloons in St. Louis.

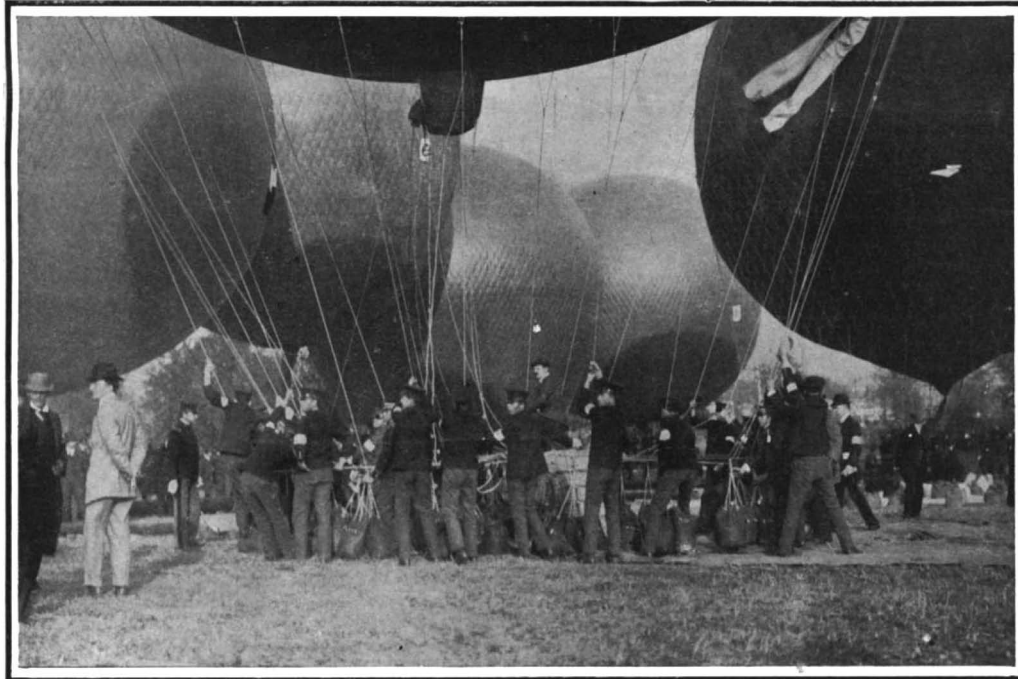

"Are You Ready?" The Last Moment Before the Start.

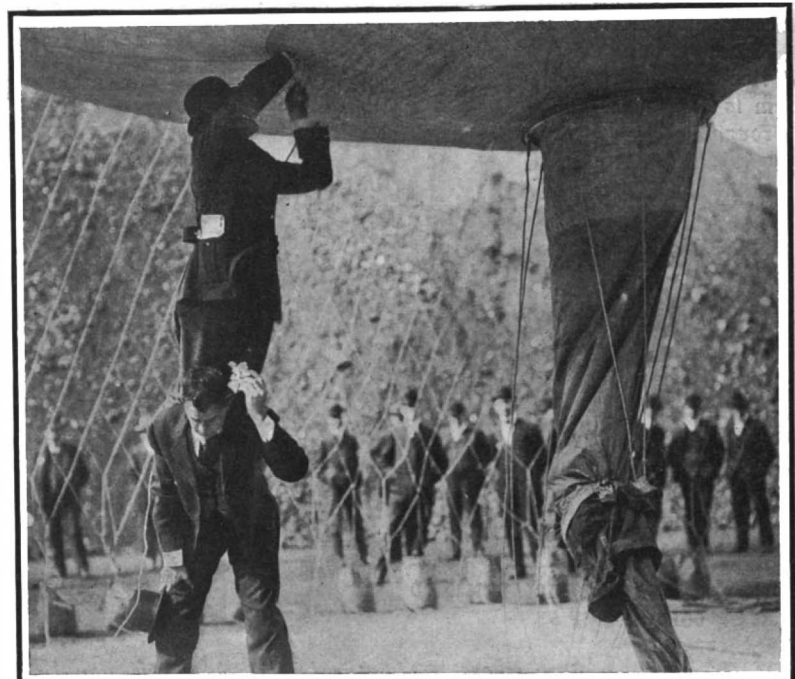

The Final Examination: "Is There a Leak?"



View of the Park Before the Balloons Were Inflated. The Gas Mains Connected and the Ballast Bags Ready.

THE LONG DISTANCE BALLOON RACES FROM ST. LOUIS.

**A CONVENIENT POCKET TRANSIT.**

BY A. FREDERICK COLLINS.

A pocket transit combining the useful features of a level, prismatic compass, and clinometer, is shown in the accompanying illustration. It was designed by W. D. Versehoyle, Esq., of London, England, a mining engineer who has wide experience in the use and application of various forms of instruments intended for preliminary surveys.

The distinguishing feature of the instrument is that, owing to its novel construction, only one observation is necessary to obtain both the magnetic bearing and the vertical angle of any distant point. It is also specially adapted for use in difficult positions such as are always liable to occur in filling in the rougher details in a mining survey.

For rapid topographical work and working in constrained positions, it saves half of the labor. Another important point is that its efficiency is not determined by the length of the diameter of the compass, as is ordinarily the case. With even a small instrument the same length of sight is obtained as would be possible with a 6-inch or 7-inch prismatic compass. The engineer can, himself, if necessary, make all the necessary adjustments.

To use the instrument for obtaining horizontal and vertical angles, after freeing the needle and unfolding the arm, the compass box is grasped in the left hand and with the extended fingers of the right hand the arm of the transit is lightly grasped, when the distant target or light is brought to the intersection of the cross lines at the end of the arm.

When the arm is held firmly in that position the compass box should be slightly revolved until the bubble in the small level is seen to be at the central mark. The magnetic bearing will now be plainly visible in the prism at the same time that the target is viewed along the sight line and the angle of depression or elevation is automatically recorded on the vertical arc. Both readings can then be taken at the same time without further observation.

A clinometer is an instrument used for taking the dip and strike of rock strata. In its commonest form it consists of a protractor with a pendulum attached. When the clinometer lies horizontally the indicator points to 0 deg., and when inclined the amount of inclination is shown at once by the pendulum. In the instrument under consideration the clinometer and compass are combined in one instrument. When the device is used as a clinometer the bottom side of the arm is laid on the object to be observed and, looking through the window at the top of the compass box, the latter is slightly revolved until the small bubble comes to the center, when the angle may be read off the vertical arc.

Should it be necessary to alter the relative position of the divided ring and the magnetic needle this can be done by removing the cover and altering the position of the needle immediately under the divided ring. Adjustment for magnetic variation may be obtained in this manner without disturbing the other adjustments.

The pocket transit is designed as a serviceable instrument and is built to withstand the rough usage an instrument of this nature is liable to receive.

**NATURAL AND ARTIFICIAL MIXED COLONIES OF ANTS.**

BY LOUIS I. DUBLIN, PH.D.

It is a commonplace in Nature that animals are subjected to a constant and severe struggle for existence. There are in every species more individuals than can be comfortably or even properly fed or housed. The result is competition all along the line. This is particularly true of such animals as the ants, for they are not only the commonest of all our insects, but living entirely on the ground, are more crowded than the rest, and are all the more subject to that destructive competition. We, accordingly, find here and there two or more colonies of the same or closely-related species thrown into close proximity, often living underneath the same stone and within the confines of the same nest. As might be expected in such cases, the two forms maintain independent households; for it is not choice but necessity that has brought them together. Ordinarily, ants are extremely jealous of their independence, and will not tolerate the intrusion of any stranger within their midst. In like manner, no single individual or a small number of individuals will venture into a strange nest. Within each home, the constant fighting of other animals is never observed. But how different when once a stranger is thrown into the nest! The

workers, that apparently never before knew violence, fall upon the intruder, and soon rend her or drive her out. This is almost an invariable experience, and is not limited to ants of distant relationship. Ants of the same species, if not of the same community, show this same antipathy toward each other. It is either the same blood or death.

If, then, through the stress of circumstances, two such colonies are thrown together, they remain at best

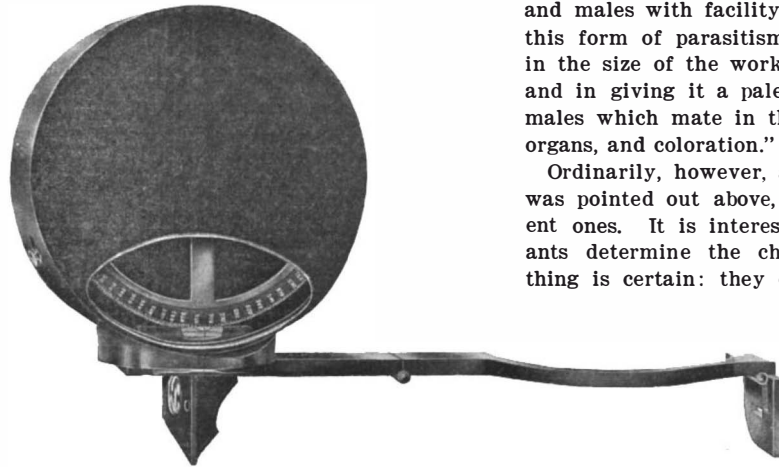

POCKET TRANSIT FOR PRELIMINARY SURVEYS.

quite indifferent to each other, build barriers between their two parts, and do not intermingle. These may be called cases of accidental association, the ants being closely related, and possessing very similar habits as to food and the character of the location for their nest.

Much more pronounced are the conditions in which the two different colonies are systematically united. Although they may be able to live alone, they are usually found together. There seems to be some advantage accruing to either one or even both of the neighbors from this mixing. Generally, it is a one-sided advantage.

The most interesting of these associations are those in which one species actually preys upon the other. Spread over most parts of the globe, is a group of tiny ants of the genus *Solenopsis*, whose plan of life is to kidnap the young of other ants for food. As might be expected, they are entirely subterranean, and therefore blind. Guided by their strong sense of smell, they pick out for their depredations the well-stocked nest of almost any one of the common species of larger ants, and locate their homes close by. Either surrounding the nests of the latter, or even right in among the galleries, they excavate their own tiny galleries and chambers. In this lies their protection; for while they have the easiest access into the home of their prey, the latter are absolutely unable to follow them and make a return raid.

Every little now and then, they make sallies in large numbers into the surrounding nest, and attack the

remarkable example of modified structure in adaptation to environment; perhaps the most striking in the ant world. Forel, the greatest of living ant students, says: "It is obvious that the small size of the worker is its safeguard. For owing to its minuteness, it succeeds in insinuating itself into the young brood of large ants without being seen by the defenders. . . . As it lives near its hosts, it requires neither size nor strength for seeking its food at a distance, and it is, therefore, in a position to nourish its enormous females and males with facility. Thus, it is easy to see how this form of parasitism should lead to a diminution in the size of the worker, in depriving it of its eyes, and in giving it a pale color, while the females and males which mate in the air retain their size, visual organs, and coloration."

Ordinarily, however, ants of one community are, as was pointed out above, very hostile to ants of different ones. It is interesting, then, to inquire how the ants determine the character of an intruder. One thing is certain: they do not make mistakes. Again and again have investigators removed one or more individuals from a colony, and after a year or even longer returned them to their nest. In every such case, the strangers were recognized and accepted with apparent glee. In one instance, the period was as long as two years.

From the study of the senses and sense organs of the ants, it is clear that no sense but that of smell could have served in this identification. This is confirmed by a multitude of circumstances. First, it is the antennæ or feelers of the ants which are put into immediate contact with the stranger. Second, if one of the same colony be covered with the blood of ants from a foreign nest, she will, in most cases, not be accepted, but treated as a stranger. Third, the young of strangers will be more readily tolerated than older individuals. There can be no doubt that ants of different colonies possess distinct odors, which become more diverse with the diversity of the two forms. These odors are the telltale, and it is they that make the ants intolerable to one another. The sense of smell is, therefore, the bar to the indiscriminate fraternizing of different colonies.

But, as is well known, the antennæ are the seat of the sense of smell. We have it, therefore, in our power to modify the life of these animals at our pleasure. If we remove the antennæ, we also destroy the mutual animosity. Indeed, it is necessary to remove only the last few segments of the feelers, inasmuch as it is in them that the power of distinguishing friends from enemies resides. The operation is neither difficult nor very painful to the ant, and has often been performed by various experimenters. Under proper care, the wound soon heals, and but for this slight loss, the animal is in much the same physical condition as before the operation. When placed together, ants of the most diverse origin can be made to live amicably.

There is one other method of attaining the same results which has considerable interest. Some twenty-five years ago, Sir John Lubbock, now Lord Avebury, studying the question of recognition among certain species of ants, discovered that if the unborn young still within the cocoon be isolated, permitted to emerge, and then replaced into the old nests, they would be received as friends. Here, however, his experiment stopped, and he just missed making the important discovery that if these newly-born individuals be placed together, even if they belong to colonies of deadly enemies, they would fraternize as do the sisters of the same mother. This discovery we owe to Miss A. M. Fielde.

The accompanying photograph is from one of Miss Fielde's remarkable mixed nests. You will observe side by side ants of four distinct species of very considerable diversity

in size and structure. Under ordinary conditions, these individuals would fight one another to the death, but in this nest they lived for a considerable period without the least disturbance. They were often seen feeding one another, playing, and in all other respects behaving as ants of one family.

A glance at the picture will show that all of these possess their feelers, and are not in any sense maimed. They were thrown together just before they had hatched. At that early period, they had not as yet

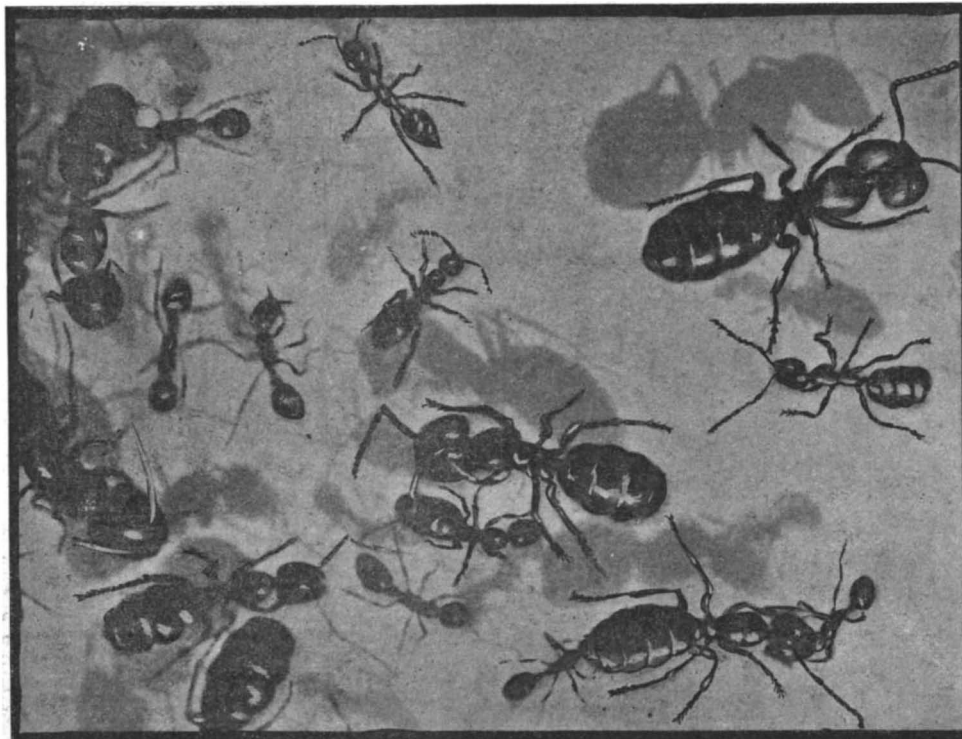

NATURAL AND ARTIFICIAL MIXED COLONIES OF ANTS.

well-advanced babies or pupæ. In groups of eight or ten they tear these defenseless young to pieces, and carry them off in large masses to their own lairs, where they feed both themselves and their large kings and queens at their leisure.

In a fight, they are the equal of the strongest. Even that renowned fighter, *Formica sanguinea*, the blood-red slave-maker, is overpowered by them. What they lack in size they make up in numbers and in the fierceness of their onslaught. We have in this species a

learned the odor of their own nest, nor had their bodies developed the distinctive odor which later characterizes every individual of the colony. Placed together within narrow bounds from the very beginning, the different ants soon developed an odor common to them all, or at any rate, one that each will tolerate in the others.

It is likely that in some such way as this the mixed colonies in Nature arose. It would be necessary only that the newly-hatched young of two species living near each other be brought together through one cause or another. The young would soon learn each others' odors, and this would insure peace in their midst ever after.

**AN INTERESTING TYPE OF COW MILKER.**

A request was recently received from one of our readers for information regarding a cow milker patented March 25, 1865. Our correspondent desired, if possible, to have one of these machines repaired. The

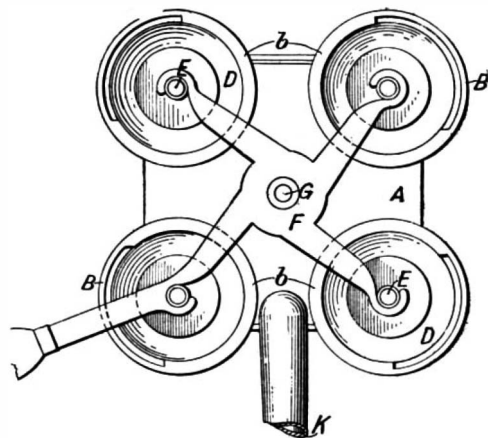

**VIEW SHOWING UNDERSIDE OF COW MILKER.**

fact that a cow milker of such remote date could survive to this day and still be considered of practical value interested us. Although we failed to trace the present address of the manufacturers, we discovered that the design of the machine involved a very novel principle in pump mechanism. A photograph of our correspondent's cow milker is shown herewith, and the accompanying drawings are copied from the original patent granted to L. O. Colvin, of Philadelphia, Pa. One of the illustrations is a cross-sectional view, and the other shows the under side of the milker.

The machine consists of an approximately rectangu-

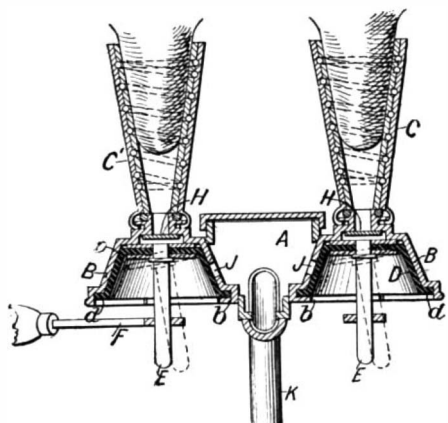

**CROSS-SECTIONAL VIEW OF THE COW MILKER.**

lar chamber A, formed at each corner with an inverted cup B. Communicating with each cup is a teat tube C, formed of rubber, in which a spring is imbedded. Fitted into each cup B is a cup-shaped valve D. The lower rim of each valve D is formed with a flange d, which rests upon a flange b formed on the cup B. The valves D are fastened to rods E, and these rods are engaged by the arm of a spider F pivoted at G to the under side of the chamber A. Each cup B is formed with a port J, which leads into the main chamber, and between the cups B and their respective tubes C are clap valves H. To operate this cow milker

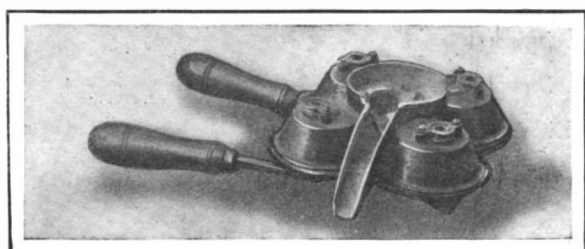

**AN INTERESTING TYPE OF COW MILKER.**

the spider F is oscillated on the pivot G as a center, which serves to tilt the rods E to the position shown by the dotted lines. As the valve cups D are flexible, they wobble with the shafts E, and produce an alternate exhaust and compression in the cups B. In applying this cow milker, the tubes C are fitted over the teats, and then the operation of the spider F serves

first to draw the milk into the cups B, and then, when the clap valves H close on the return stroke, to force the milk through the ports J into the chamber A, whence it flows out through the tube K into the desired receptacle.

The particular advantage claimed for this cow milker by the inventor is that the four pumps while operating simultaneously act independently of each other, so that each teat may be milked completely dry. The inventor states that in cow milkers previously made a single pump was provided to draw the milk from the four teats of the cow; and when one or more of the teats became dry before the others, their shrunken condition permitted air to enter the pump, rendering the latter inoperative, and precluding the milk being extracted from the other teats. For this reason he used four separate pumps, so that when air was admitted into one of the tubes, it would not affect the action of the other pumps.

**FOLDING IRONING TABLE.**

The ironing table shown in the accompanying engraving should prove very useful in the household, owing to its stability and lightness, and also to the fact that it can readily be folded to occupy a very small space when not in use. The table top is of the form of the usual ironing board, and is supported at its large end by a frame section A, hinged thereto. The board is also supported midway of its length by a second frame section B. The lower end of section B is provided with notches adapted to fit over a rod projecting from each side of section A. The notches in section B may best be seen in the view showing the folded table. Hinged to the upper end of section A is a section D which extends diagonally down to the floor below the smaller end of the board. To hold this section D in the desired position, a pair of bars C are hinged thereto at one end, while at the opposite end they engage the rod projecting from the lower

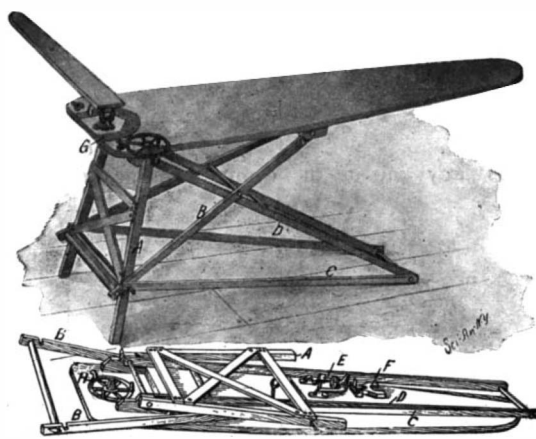

**FOLDING IRONING TABLE.**

end of section A. A cross bar on section B rests on the section D to support the ironing board. When it is desired to fold the board it is merely necessary to unhook the bars C and disengage the bars B from the rod on section A, when the sections will collapse to the position shown in the illustration. In this position they are secured by means of a hook. The invention also provides a sleeve board which is secured to the ironing board by means of a swivel bracket E and supported by means of a prop F which rests on a corrugated metal surface G. The sleeve board may be turned to any desired angle and may be easily removed or applied to the main ironing board whenever desired. Another attachment is a support for a flat-iron which is provided with a heel H adapted to engage one of a pair of sockets on the main ironing board. When the ironing table is folded, the flat-iron support and the sleeve board are made fast to the under side of the ironing board. The form of the ironing board is such that ample space is allowed for the manipulation of skirts or other circular garments. The inventor of this folding ironing table is Mr. Aaron M. Springer, Box 688, Portland, Ore.

**EXTENSION TABLE.**

In place of using separate leaves for extending a dining room table a recent invention provides an extension top something like the roller top of a desk which will fold under when the table is closed. The table may then be extended to any desired length by merely drawing out the ends. The construction is clearly shown in the cross-sectional view. It will be seen to comprise three sections, a central section and two end sections. The latter are adapted to fold against the central section running in grooves D. The top of the central section is formed of two stationary boards A. Connected with each board is an articu-

lated section B. Each section B is formed of a series of bars of keystone form in cross section to permit them to swing toward each other when passing around curves. Fitted lengthwise between each pair of bars is a tube, and a series of springs serve to hold the bars against the tubes. Thus the bars are held in flexible hinged relation to each other. The ends of the extension sections B are guided on tracks C and E carried by the end sections of the table. Both of the tracks curve down under the table top. The track

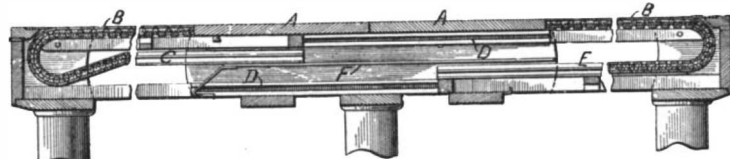
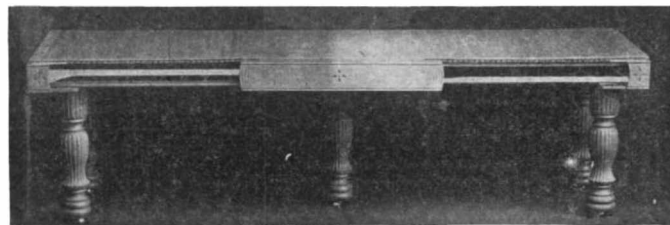

**ROLL-TOP EXTENSION TABLE.**

C runs above the track E. A flange F separates the two sections B when they are in their folded position. Stop pins are provided to prevent the parts from being extended far enough to withdraw the articulated sections from their guides. A patent on this extension table has just been granted to Mr. Emory A. Fuller, 27 Lombard Terrace, Detroit, Mich.

The number of fatal Alpine accidents during the past summer has been the highest ever recorded. Ninety accidents have occurred, resulting in eighty deaths and twenty-two injuries. About half the killed were guides, and thirty-one were persons spending vacations in Switzerland. Three-fourths of the fatalities were due to falls over precipices. The others were due to snowstorms, avalanches, or lightning.

**ATTACHMENT FOR TRACTION-OPERATED IMPLEMENTS.**

An attachment for farm implements, particularly harvesters, binders, and the like, has recently been invented, which provides means for operating such implements independently of the traction wheels. It consists of a motor, preferably a gasoline motor, of such design and so mounted that it can easily be attached to any implement. The motor is supported on a platform which is secured by U-shaped bolts to a pair of tubular members. By means of a number of U-shaped clamps, these tubular members may be quickly secured to the side frame members of the implement. The motor is provided with sprocket gearing, whereby it may be operatively connected with the machinery of the implement. No changes whatever are made in the structure of the implement, and in applying the attachment, all that is necessary is to remove the chain from the sprocket gear carried by the traction wheel, and connect the sprocket gear of the motor to the driving sprocket of the mechanism. The accompanying engraving shows the motor in position on a harvester and binder. The motor is inclosed in a casing to keep out dust and dirt. The casing may be opened to provide access to any part of the motor whenever desired. The engine employed is a comparatively small one, and its weight does not materially increase the weight of the implement; but as it operates all the mechanism of the harvester and binder, the power required of the horses to draw the implement is reduced to a very material extent, thus making it possible to operate the machine at a much faster rate and with greater efficiency. If any-



**ATTACHMENT FOR TRACTION-OPERATED IMPLEMENTS.**

thing should accidentally happen to the engine, or the supply of fuel run out, the driving chain may be again applied to the sprocket gear on the traction wheel, and the machine operated in the same manner as before. A patent on this improved attachment has been granted to Messrs. G. O. Helvig and E. Danielson, of Dawson, Minn.

RECENTLY PATENTED INVENTIONS. Of General Interest.

REINFORCED CONCRETE JETTY.—W. C. COTTRELL, Asbury Park, N. J. The invention has for its object the construction of a jetty of reinforced concrete piles adapted to hold sand washed along the beach by the currents of the ocean and thereby to build up the beach to the desired height. Each pile is provided with a tenon on one side and a groove on the other, so that they may be driven to form a continuous wall.

DISPLAY-RACK.—F. H. CORWIN, Riverhead, N. Y. The display rack is of novel construction adapted particularly to hold display cards and photographs and to enable a particular card to be inserted into or removed from any part of the rack without disturbing the other cards therein. The racks are preferably of double construction so that a double set of photographs may be inserted in each of the several sections of each compartment.

COPY-HOLDER.—E. B. DUKE, Cookeville, Tenn. This copy-holder is adapted to be adjusted to typewriters of different makes. It will rest securely in an upright or folded position, because the center of gravity of the copy rack holds the same in place. The rack may be turned laterally to different positions, and may also be adjusted to convenient heights. As the device will fold it may be used in drop cabinets.

MARKING-GAGE.—A. SOLOMON, New York, N. Y. The object of Mr. Solomon's invention is to provide an improved marking gage more especially designed for the use of carpenters, joiners, cabinet makers, and other mechanics, and is arranged to permit of conveniently and accurately laying out mortises and the like. The construction is very simple and the markers and the abutment bars may be quickly adjusted to suit the work in hand.

REINFORCEMENT FOR CONCRETE ARCHES.—M. A. ABBOTT, Chrisney, Ind. The object of this invention is to provide a structure easily and quickly assembled, readily bent to the desired form and furnished with means for holding it in place while concrete is applied and is hardening. The invention also provides a reinforcement for arches comprising a single structure of metal bars which forms not only the arch but the spandrels, balustrades, wing walls, and floor.

MUFF-HOLDER.—L. W. SCOTT, Boston, Mass. Mr. Scott has invented a muff holder of a type resembling a huge safety pin. The main frame is rectangular and is formed with a hanger. The lower bar of the frame is a spring member which may be released from engagement with the frame at one end to receive the muff and then hooked fast thereon. The holder is curved horizontally so as to preserve the proper shape of the muff.

DEVICE FOR LAYING CONCRETE PAVEMENTS.—G. W. and G. F. SWITZER, Salisbury, N. C. By means of the device forming the subject of this invention, it is possible to more rapidly "float" and trowel the surface of concrete pavements and also to lay the surface off into panels with margin lines and beveled edges after the usual manner, but in considerably less time.

DISPLAY-RACK.—R. E. MARTIN, Davenport, Iowa. Means are herein provided for supporting any desired number of samples of wall paper so arranged as to readily indicate the character of each sample and enable such of the individual samples, as may be desired, to be displayed in combination with each other so as to show the general effect, as when samples of wall, border, and ceiling papers are displayed in proper relation to each other.

NOTE.—Copies of any of these patents will be furnished by Munn & Co. for ten cents each. Please state the name of the patentee, title of the invention, and date of this paper.

INDEX OF INVENTIONS

For which Letters Patent of the United States were Issued for the Week Ending

October 22, 1907.

AND EACH BEARING THAT DATE

[See note at end of list about copies of these patents.]

Table listing various inventions and their patent numbers, including items like 'Abrading or cutting tools, driving mechanism for machines for operating, C. J. Fancher', 'Acid and making the same, para-aminodiphenylamine sulfonic, E. Erdmann', etc.

'Star' Lathe advertisement featuring an illustration of the machine and text: 'FOR FINE, ACCURATE WORK. SEND FOR CATALOGUE B. SENECA FALLS MFG. CO. 695 Water Street, Seneca Falls, N. Y., U. S. A.'

'Engine and Foot Lathes' advertisement: 'MACHINE SHOP OUTFITS, TOOLS AND SUPPLIES. BEST MATERIALS. BEST WORKMANSHIP. CATALOGUE FREE. SEBASTIAN LATHE CO., 120 Culvert St., Cincinnati, O.'

'Foot and Power' advertisement: 'and Turret Lathes, Planers, Shapers, and Drill Presses. SHEPARD LATHE CO., 133 W. 24 St. Cincinnati, O.'

'THE CLIPPER CLIP' advertisement with illustration: 'Its triangular shape prevents entangling and gives three times the capacity of any other clip for attaching papers together. Best & Cheapest. All Stationers. CLIPPER MFG. CO., 401 West 124th St., New York, U.S.A. Send 10c. for sample box of 100; or 20c. for clips and desk tray.'

'Veeder Counters' advertisement with illustration: 'to register reciprocating movements or revolutions. Cut full size. Booklet Free. VEEDER MFG. CO., 15 Sargeant St., Hartford, Conn. Cyclometers, Odometers, Tachometers, Counters and Fine Castings. Price \$1.00'

'ADD TONE TO YOUR STATIONERY' advertisement: 'BANK, SCHOOL OR HOME BY USING ONLY WASHBURN'S PATENT ADJUSTABLE "O.K." PAPER FASTENERS. There is genuine pleasure in their use as well as Perfect Security. Easily put on or taken off with the thumb and finger. Can use repeatedly and they always work. "Made of brass, 3 sizes. Send 10c for box 50 as shown. At all stationers. Illustrated booklet free. The O. K. Mfg. Co., Dept. X, Syracuse, N. Y.'

'PATENTS' advertisement: 'Our Hand Book on Patents, Trade-Marks, etc., sent free. Patents procured through Munn & Co. receive free notice in the SCIENTIFIC AMERICAN. MUNN & CO., 361 Broadway, N. Y. BRANCH OFFICE: 625 F St., Washington, D.C.'

'Automatic Water Supply' advertisement: 'Most economical, reliable and efficient. If you have running water the Niagara engines will elevate 35 feet for each foot-fall obtainable from spring, brook, or river, delivered to any distance. Write for catalogue. Niagara Hydraulic Engine Co., 140 Nassau Street, N. Y.'

'WORK SHOPS' advertisement: 'of Wood and Metal Workers, without steam power, equipped with BARNES' FOOT POWER MACHINERY allow lower bids on jobs, and give greater profit on the work. Machines sent on trial if desired. Catalogue Free. W. F. & JOHN BARNES CO. Established 1875. 1999 RUBY ST. ROCKFORD ILL.'

'DO YOU USE GRINDSTONES?' advertisement: 'If so we can supply you. All sizes mounted and unmounted, always kept in stock. Remember, we make a specialty of selecting stones for all special purposes. Send for catalogue "1" The CLEVELAND STONE CO., 2d Floor, Wilshire, Cleveland, O.'

'THE BARKER MOTOR' advertisement: 'has from the first shown itself to be of superior design. Mechanical ideas of proven worth, combined with the best materials and careful attention to details make it THE LEADER OF ITS CLASS. G. L. BARKER, NORWALK, CONN.'

'ELECTRICAL APPARATUS REPRODUCED BY CONVENTIONAL DIAGRAMS IN DRAWINGS' advertisement: 'Fifty diagrams showing the usual method of illustrating electrical apparatus in drawings. A labor saving paper. Contained in SUPPLEMENT 1106. Price 10 cents. For sale by Munn & Co. and all newsdealers.'

'THE B. F. BARNES 14-INCH DRILL' advertisement: 'is adapted for work from 1-16 inch to 1/2 inch. A strong, substantial, well built drill. Plain lever or power feed as desired. We build a full line of Drills. All sizes furnished in Gangs. Also have 9-inch and 11-inch Screw Cutting Lathes, and a 24x2-inch Wet Tool Grinder. Catalog 8 on request. B. F. BARNES COMPANY, Rockford, Ill. European Branch, 149 Queen Victoria St., London, E.C.'

'Cushman THE Man Who Gets THE MOTOR' advertisement: 'Just invest enough money to insure Good Material and Workmanship. Cushman Motors have ground cylinders, pistons, piston rings and crank shafts, crank and piston pins hardened, gas tight adjustable bearings. All parts finished according to micrometer measurements and are interchangeable. Write for Catalogue if interested. Engines from 2 to 14 h.p., 2-cycle, light weight, easy starting, Cushman Motor Co., Lincoln, Neb. 8 H. P. Weight 185 lbs.'

Main index table listing inventions and their patent numbers, including items like 'Axle box, car, H. C. McCarty', 'Bales, means for changing the shape of and compressing, S. J. Webb', 'Band cutter and feeder, W. A. True', etc.

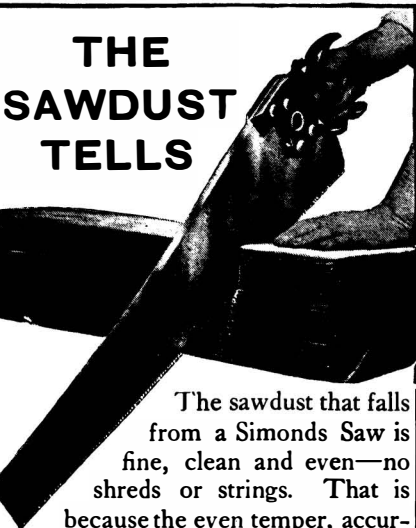

THE SAWDUST TELLS

The sawdust that falls from a Simonds Saw is fine, clean and even—no shreds or strings. That is because the even temper, accurate workmanship, and perfect setting and sharpening of a Simonds Saw cause every tooth to cut the same—making a smooth continuous cut.

SIMONDS SAWS Are the Best and They ARE the Best

The wonderful evenness of temper, and the remarkable edge-holding quality of Simonds Saws are due largely to the fact that they are

MADE OF SIMONDS STEEL

the best saw steel in the world, made in a Simonds Steel Mill, exclusively for Simonds Saws. Experience and workmanship combined with this exclusive material give the perfect result.

The skilled artisan will insist on having a "Simonds." Your hardware dealer should promptly supply you with a Simonds Saw of any style, point or size. If your dealer does not keep The Simonds, us know and send us his name and address.

Send for "Simonds Guide" Mailed Free

This booklet will tell you about Simonds Saws and give other information of real interest and value.

SIMONDS MFG. CO., FITCHBURG, MASS. CHICAGO NEW ORLEANS SAN FRANCISCO PORTLAND NEW YORK SEATTLE

BLAKE TUBE FLUX For SOLDERING



BLAKE SIGNAL & MFG. CO., 246 Summer St., Boston, Mass.

A Home-Made 100-Mile Wireless Telegraph Set

Read SCIENTIFIC AMERICAN SUPPLEMENT 1675 for a thorough, clear description, by A. Frederick Collins, of the construction of a 100-mile wireless telegraph outfit. Numerous, adequate diagrams accompany the text. Price 10 cents by mail. Order from your newsdealer or from

MUNN & CO., 361 Broadway, New York



GILSON MFG. CO. 100 Park St. Port Washington, Wis.

You cannot fail to make money with the assistance of our complete One Light System, in case \$10. "THE LIGHT that NEVER fails." U. S. Systems approved by the Board of Underwriters. Simple, safe and durable. Write for catalogue illustrating our full line. NATIONAL STAMPING AND ELECTRIC WORKS 150-158 S. Jefferson St., Chicago, U. S. A.

Build It Yourself Any boy or amateur can build this perfect little 1 H. P. vertical, 2 cycle gasoline engine on a foot power lathe from rough castings by following our simple blue print working drawings. Others are doing it, so can you. No engine equals it for simplicity, strength and durability. Fills every requirement where light motive power is needed. Write for booklet and prices on castings and finished engines. GARDNER MOTOR COMPANY 5011 Delmar Ave., St. Louis, U. S. A.

Atlantic City 3 HOURS FROM NEW YORK VIA NEW JERSEY CENTRAL Solid Vestibule Trains, Buffet Parlor and Dining Cars. Leave West 23d St. 9.50 a.m. daily; 12.50 p.m. (Saturdays only); 3.20 p.m. daily (except Sundays); 4.20 p.m. (Sundays only). Leave Liberty St. 10.00 a.m. daily; 1.00 p.m. (Saturdays only); 3.40 p.m. daily (except Sundays); 2.30 p.m. (Sundays only)

Table listing various items and their prices, including Lumber, Marine table, Molding machine, and many other mechanical and electrical components.

SORE THROAT To prove the Efficiency of Hydrozone

to Sore Throat Sufferers, I will send One 25 Cent Bottle Free to anyone mentioning this paper and sending 10 cents to pay postage and packing. Hydrozone is a harmless germicide, indorsed and successfully used by leading physicians. Not genuine without my signature on label. Ask for Booklet on Treatment of Diseases. Sold by Leading Drug-gists.

THE Nulite Vapor Lamps For Home, Store and Street We also manufacture Table Lamps, Wall Lamps, Chandeliers, Street Lamps, Etc. 100 Candle Power seven hours ONE CENT. No Wicks. No Smoke. No Odor. Absolutely safe. THEY SELL AT SIGHT. Exclusive territory to good agents. Write for catalogue and prices. Chicago Solar Light Co. Dept. G. Chicago

RADIUM AND THE RADIO-ACTIVE Substances. No better or clearer scientific account has been published than that contained in SCIENTIFIC AMERICAN SUPPLEMENT 1429. The paper presents all that is at present known about radium and the radio-active substances. Price 10 cents, by mail. Munn & Co., 361 Broadway, New York City and all newsdealers.

DO YOU SHAVE YOURSELF? Then get a brush, the hairs of which will never come out. Our new Everlasting Shaving Brush has the hairs cemented and set in an aluminum ferrule by our patent process; guaranteed perfect for three years. A new brush free if a single hair comes out. SPECIAL: To introduce our catalog of razors and supplies for home shaving, we offer this 15c. brush for 25c. Complete catalog on home shaving Free Home Barber Supply Co., 806 E. Madison St., Chicago

LENSES Besides making all kinds of PHOTOGRAPHIC LENSES we manufacture to order lenses of every description, including stereoscope, surgical instrument, lantern lenses, magnifying mirrors, etc. Write for estimates and samples. We make 35 different styles and sizes of PHOTOGRAPHIC SHUTTERS and our factory is especially equipped to manufacture fine small metal articles of all kinds, furnishing the dies if desired. Estimates on application. Wollensak Optical Co., 292 Central Ave., Rochester, N. Y.

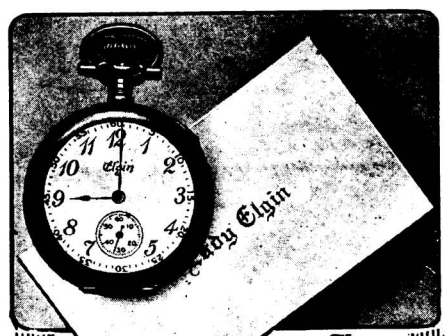

The Smallest Watch Made in America.

The Lady Elgin

Social requirements and the obligations of the home will be met promptly on time all the time if you place your dependence upon the Lady Elgin—a new Elgin for womankind. Illustration actual size of watch. Every Elgin Watch is fully guaranteed; all jewelers have them. Send for "The Watch," a story of the time of day. ELGIN NATIONAL WATCH CO. ELGIN, ILL.

SETS OF CASTINGS OF MODEL ENGINES SEND 10¢ FOR 126 PAGE ILL. CATALOGUE. ALSO TOOLS, GEAR WHEELS & PARTS OF MODELS GOODNOW & NIGHTMAN BOSTON Removed to 182 Milk Street.

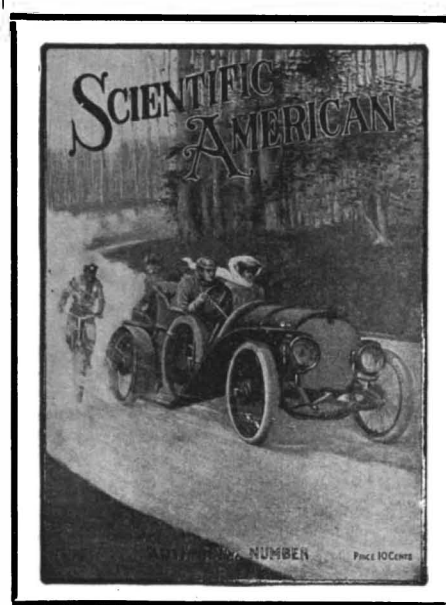

OUT NOVEMBER 9, 1907 THE SPECIAL Automobile Number of the Scientific American Handsome Cover in Colors Lavishly Illustrated Price Ten Cents

HIS SPECIAL NUMBER will contain a greater number of detailed descriptions of improvements in construction of all American Automobiles than ever before published. Engines, transmissions, steering gears, shock absorbers, axles, frames and all other parts of importance will be illustrated and described in detail. There will also be a page of Automobile Novelties, consisting of various accessories of use to the user. The description of new features will be more complete than ever before, and the issue will show, in a condensed form, the progress which has been made in automobile construction during the past twelve months. ORDER FROM YOUR NEWSDEALER OR FROM MUNN & CO., 361 Broadway, New York City

Classified Advertisements

Advertising in this column is 50 cents a line. No less than four nor more than ten lines accepted. Count seven words to the line. All orders must be accompanied by a remittance. Further information sent on request.

BUSINESS OPPORTUNITIES.

FOR SALE—High grade manufacturing business. Specialty in good demand. Value appreciated only on investigation. Good reasons for selling. Knight Bros., 20 Broad Street, New York.

FLYING MACHINE.—I want financial backing to build one that will readily rise from the ground and maintain stability in the air; it can be steered at will and make any kind of speed. C. G. Lundin, 22 Grandview Ave., Brooklyn, N. Y.

FOR SALE.—Incorporated company, business established, will sell stock or entire business and patents. Manufacture ironing boards and folding tables. Address John A. Keck, Decatur, Ill.

LET US MARKET YOUR PRODUCT.—We want a patented article of merit, and have abundant capital and excellent organization to sell your goods. Offices in 12 cities. Full description necessary to secure attention. W. J. S., Box 1828, New York.

GREAT OPPORTUNITY.—Selling goods by mail; improved plan, new catalogue listing high-class merchandise. If you can invest \$25 to \$100, write us, we will show you an easy way. Milburn-Hicks, 815 Pontiac Building, Chicago.

INVENTORS AND MANUFACTURERS, having new, useful, untried articles (no toys), investigate. With an efficient corps of canvassers, we operate in Idaho, Washington and Oregon. Goods bought outright. Correspondence solicited. Novelty Distributing Co., 114 Second St., Walla Walla, Wash.

INVENTORS.—Send for free sample copy "World's Progress," devoted to interests of inventors. All latest developments in scientific and industrial work. World's Progress, 510 12th St., Washington, D. C.

INVENTORS, MANUFACTURERS!—Special machines designed, built, repaired, and experimental work executed in a well-equipped machine shop. J. G. C. Mantie, Mechanical Engineer, 1907 Park Ave., New York.

PATENTS FOR SALE.

PATENT RIGHTS BRITISH No. 25,011 of tube cutter for cutting tubes in position out of boilers. Apply John Abridge, 57 Phoebe Anne Street, Liverpool, England.

AGENTS WANTED.

AGENTS WANTED.—Big profits; Gre-Solvent cleans hands instantly; removes grease, paint, ink, etc.; every mechanic buys; get sample and terms. Utility Co., 646 West 44th Street, New York.

AGENTS WANTED in every county to sell the Transparent Handle Pocket Knife. Good commission paid. From \$75 to \$300 per month can be made. Write for terms. Novelty Cutlery Co., No. 2 Bar St., Canton, O.

EXCLUSIVE AGENCIES GIVEN.—We want a good man in every town to sell first-class electrical specialties during spare hours to houses, stores and especially factories. Easy sellers and good big profit. Write for our Sole Agency. Hill-Wright Electric Company, 105 Reade Street, New York City.

TYPEWRITERS.

START MAKING MONEY by buying a reliable rebuilt typewriter. Remingtons, \$15; Hammonds, Caligraphs, Williams, Blickensderfers, Franklins, \$10 up. Rentals, repairs. "Atlantic" Typewriter Ex., Dept. 8, 245 B'way, N. Y.

MOTION PICTURES.

THE MOVING PICTURE WORLD, weekly, 10 cents per copy; yearly subscription, \$2. The only paper devoted to the moving picture, illustrated songs and lantern lecture field. Moving Picture World, Box 450, N. Y.

WANTED.—Addresses of enterprising men contemplating entering the moving picture business. Biggest paying proposition for small capital known. Write for information. The Actograph Co., 50 Union Square, N. Y.

MODELS & EXPERIMENTAL WORK.

EXPERIMENTAL WORK.—Machines designed for special purposes and built to order. Send sample, sketch or blue-print for estimate. Hull Brothers, 56 Hudson Street, Jersey City, N. J.

INVENTIONS PERFECTED.—Mechanical Drawings, Tools, Dies, Special Automatic Machinery and Novelty machines manufactured. The Victor Model and Novelty Co., Phone 3359 Worth, Corner Pearl and Centre Sts., N. Y.

BOOKS AND MAGAZINES.

ELECTRICIAN AND MECHANIC.—Practical monthly magazine for electrical and mechanical students and workers. Publishes illustrated directions for constructing dynamos, motors, gasoline engines, wireless telegraphy, electroplating, electrical wiring, mechanical drawing, using tools, furniture construction, boat building, all kinds of mechanical work. One dollar yearly; trial subscription for three months, twenty cents. List of electrical and mechanical books free. S. A. Sampson Pub. Co., 6 Beacon St., Boston, Mass.

EDUCATIONAL.

UNITARIAN LITERATURE will be sent free by the Post Office Mission of the Hingham Branch Woman's Alliance. Please send your name to Mrs. Starke Whiton, Hingham Centre, Mass.

CORRESPONDENCE SCHOOLS.

PATENT LAW AND OFFICE PRACTICE BY MAIL. Free booklet and specimen pages of thoroughly practical course. Price reasonable. Correspondence School of Patent Law, Dept. A, 1853 Mintwood, Wash., D. C.

SCHOOLS AND COLLEGES.

PRACTICAL INSTRUCTION in the engineering use of Algebra, Geometry, Logarithms, Trigonometry, Slide-rule, Planimeter, Perspective and Scales. All by mail. Geert Blaauw, 25 Broad St., 20th floor, Room 12, N. Y. City.

PHOTOGRAPHY.

AMERICAN PHOTOGRAPHY succeeds American Amateur Photographer, Camera and Dark Room and Photo Beacon. The editors of each now join in making a magazine which should be in the hands of every photographer, professional or amateur. 15 cents monthly, \$1.50 per year. Three specimen copies for a quarter. Am. Photographic Pub. Co., 361 Broadway, New York.

TALKING MACHINE NEEDLES.

I SEND FREE samples of patented improved Petmucky Multi-tone Needles to all interested in talking machines. Each needle plays 10 records. Millions sold weekly. Petmucky, 348 Broadway, New York.

DUPLICATORS.

MULTICOPYING—The Bensinger "Rapid" Duplicator, quick, inexpensive, benefits business and professional men. Numerous exact copies, forms, letters, diagrams, music, or anything in pen, typewriter. C. N. Bensinger Co., 34 Stone St., N. Y.

CONSULTING CHEMIST.

CHEMICAL EXPERT gives advice to manufacturers; manufacturing troubles removed; improvements developed. Utilizing wastes and unappreciated substances. Reducing manuf. costs. Chemical Expert, Box 773, N. Y.

MISCELLANEOUS.

OUR VACUUM CAP when used a few minutes each day draws the blood to the scalp, causing free and normal circulation, which stimulates the hair to a new, healthy growth. Sent on trial under guarantee. Write for free particulars. The Modern Vacuum Cap Co., 617 Barclay Block, Denver, Col.

Table listing various mechanical parts and their prices, including speed meters, spike pullers, spinning rings, and stoves.

Table listing mechanical tools and equipment, including tie holders, gaging machines, and tire handling tools.

Table listing various types of turbines and pumps, including elastic fluid turbines and steam turbines.

Table listing mechanical valves and mechanisms, including valve mechanisms, oil regulating valves, and valve removers.

Table listing various types of ventilators and fans, including window ventilators, door light ventilators, and torpedo projecting apparatus.

Table listing mechanical washers and cleaning devices, including washing machines, water elevators, and water heaters.

Table listing various types of wire and wire stretching equipment, including wire forming machines, wire stretchers, and wire working machines.

Table listing various types of duplicators and copying machines, including the Bensinger Rapid Duplicator.

Table listing various types of duplicators and copying machines, including the Bensinger Rapid Duplicator.

Advertisement for Boston Garter, featuring an illustration of a man in a suit and text describing the product as 'The Recognized Standard' with 'The Velvet Grip' and 'Cushion Button Clasp'.

Advertisement for Jager Marine 4-Cycle Engines, featuring an illustration of the engine and text describing its features and availability.

Advertisement for American Box Ball Alley, featuring an illustration of the bowling alley and text describing the investment and profit potential.

Advertisement for Wright's Health Underwear, featuring an illustration of the underwear and text describing its benefits for health and comfort.

Advertisement for Home Mechanics for Amateurs by George M. Hopkins, featuring an illustration of the book cover and text describing its content and price.

Advertisement for Scientific American Reference Book, featuring an illustration of the book cover and text describing its comprehensive content.

Advertisement for The Scientific American Boy by A. Russell Bond, featuring an illustration of the book cover and text describing its content and price.





## Rubber Pump Valves

For Cold and Hot Water, Oils, Acids, High Pressure Mine Service and for every pumping requirement.

Mechanical Rubber Goods of every description of unsurpassed qualities, including BELTING, HOSE PACKINGS, Gaskets, Mats and Matting, Tubings, Springs, Interlocking Tiling, Emery Wheels and MOULDED and CUT SPECIALTIES for any mechanical and commercial device.

**NEW YORK BELTING & PACKING COMPANY, Ltd.**  
91 & 93 Chambers Street, New York

**Scales** All varieties at lowest prices. Best Railroad Track and Wagon or Stock Scales made. Also 1000 useful articles, including Saws, Sewing Machines, Bicycles, Tools, etc. Save Money. Lists Free. CHICAGO SCALE CO., Chicago, Ill.

**OLE NLINNESS OF OPERATION** is one of the strong features that has helped to earn the present world-wide reputation and endorsement of the **Daus' Tip Top Duplicator**. No printer's ink used, thus avoiding soiled hands and clothing. No expensive supplies. 100 copies from pen-written, and 50 copies from type-written original. Sent on ten days' trial without deposit. Complete Duplicator, cap size (prints 4x13 inches), contains 16 feet of rolled printing surface (which can be used over and over again), \$1.50. \$5 Net less 33 1-3 per cent. discount. Take advantage of our trial offer. **Felix U. Daus Duplicator Co.** Daus Building, 111 John Street, New York

**LEARN TO BE A WATCHMAKER**  
Bradley Polytechnic Institute  
Horological Department  
Peoria, Illinois  
Formerly Parsons Horological Inst.  
Largest and Best Watch School  
In America  
We teach Watch Work, Jewelry, Engraving, Clock Work, Optics. Tuition reasonable. Board and rooms near school at moderate rates. Send for Catalog of Information.

**CRUDE ASBESTOS**  
DIRECT FROM MINES  
**R. H. MARTIN,**  
OFFICE, ST. PAUL BUILDING  
for Manufacturers use  
220 B'way, New York.

**We Will Make You Prosperous**  
If you are honest and ambitious write us today. No matter where you live or what your occupation, we will teach you the Real Estate business by mail; appoint you Special Representative of our Company in your town; start you in a profitable business of your own, and help you make big money at once.  
Unusual opportunity for men without capital to become independent for life. Valuable book A 120 and full particulars free. Write today. Address nearest office.  
**NATIONAL CO-OPERATIVE REALTY CO.**  
Phelps Bldg., Scranton, Pa. Marden Bldg., Washington, D. C.  
1000 Calif., Athens Bldg., Chicago, Ill.

**I. H. C. Gasoline Engines**  
SMOOTH RUNNING  
A line of engines adapted to the uses of all classes of mechanics. Constructed on mechanically correct principles. Everywhere distinguished for their safety and ease of management, as well as for their efficiency and economy.  
Vertical style, in 2 and 3-horse power.  
Horizontal (Stationary and Portable), in 4, 6, 8, 10, 12, 15 and 20-horse power.  
Also a 1-horse power air cooled engine.  
Stocks carried by I. H. C. local agents at all principal points. Address home office for catalogs and particulars.  
The International Harvester Company of America (INCORPORATED)  
15 Harvester Bldg., Chicago, Ill.

**GIANT STEAM SHOVELS**  
Toledo, Ohio, U.S.A.  
125 Vulcan Place  
The Vulcan Iron Works Co.

**HELMET OIL** LUBRICATES SEND FOR SAMPLE ANYTHING 13-21 S. CLINTON ST. CH. BESLY & CO. CHICAGO, U.S.A.

# IVER JOHNSON SAFETY AUTOMATIC REVOLVER

The ONLY revolver you can buy at any price, that simply CAN'T be fired until you pull the trigger, is the

## IVER JOHNSON SAFETY AUTOMATIC REVOLVER

No button to press, no lever to set before you can shoot. The safety feature IS the mechanism itself. When you pull the trigger, the rest follows—swift, hard and SURE. Our FREE Booklet "SHOTS" tells all about it and will convince you.

**IVER JOHNSON SAFETY HAMMER REVOLVER** 3-inch barrel, nickel-plated finish, 22 rim-fire cartridge. \$2 or 28 center-fire cartridge. **\$6.00**  
**IVER JOHNSON SAFETY HAMMERLESS REVOLVER** 3-inch barrel, nickel-plated finish. \$2 or 28 center-fire cartridge. **\$7.00**

Sold by Hardware and Sporting Goods dealers everywhere, or sent postpaid on receipt of price if dealer will not supply. Look for the owl's head on grip and our name on barrel.  
**IVER JOHNSON'S ARMS & CYCLE WORKS, 170 River Street, Fitchburg, Mass.**  
New York: 99 Chambers St. Hamburg, Germany: Pickhuben 4.  
Pacific Coast: Alameda, Cal. London, Eng.: 13 Cullum St., E. C.  
Makers of Iver Johnson Single Barrel Shotguns and Truss Bridge Bicycles



## Motor Buggies, Little Roadsters

FURNISHED COMPLETE OR PARTS OF SAME  
One and Two Cylinders—Vertical and Horizontal Air Cooled Motors. All Styles of Water Cooled Engines. Friction and Planetary Transmissions. Single or Double Chain Drive.  
Differentials.—We Supply all the Necessary Parts to Convert Buggies into Auto Buggies.  
**NEUSTADT AUTOMOBILE & SUPPLY CO., 3932 Olive St., St. Louis, Mo.**

## A MECHANICAL PERFECTION IS THE STARS SAFETY RAZOR

which has been tested and tried out by over five million users all over the world. It does its work with safety, comfort and dispatch.  
The blades are forged and full concaved similar to the ordinary razor blades. With proper care they will last a life time. They should be stropped occasionally to produce the best results in shaving.  
The **STAR SAFETY RAZOR** is guaranteed to meet the requirements of the heaviest beard and will not irritate the tenderest face. Easily adjusted, simple in handling, takes no time to clean the instrument after shaving.  
This razor may be inspected at any cutlery store. If you purchase a **STAR SAFETY RAZOR** you will own the best razor of its kind on the market.  
Star Razors are sold in sets from \$1.50 and up; with the automatic Stropping Machine and strop, \$4.50 a set. These Safety Razors are sold all over the world by all dealers who handle cutlery.

**THE STAR SAFETY CORN RAZOR**  
Simple, Safe and Sure, on sale by all dealers, or will be sent you from our factory on receipt of \$1.00. Both of the above articles make useful, handsome and valuable holiday gifts, and as the Christmas season approaches consider the advisability of purchasing the **Star Safety Razor** and the **Star Corn Knife** for relatives or friends.

**KAMPFE BROS., 12 Reade Street, New York**

## This Furnace Will Pay Its Way In Your Shop or Tool Room

You can never heat and harden your dies, milling cutters or other tools in a coal forge without a big percentage of loss, frequent delays and much dissatisfaction.  
You can do all your work of this kind absolutely right, economically and in half the time with this  
**Stewart Special No. 1 Oven or Muffle Gas Blast Furnace**  
It is made to use any kind of gas or crude oil. Shipped anywhere on thirty days' trial. 55 other styles and sizes made. Some for every purpose. Write for catalogue.  
**CHICAGO FLEXIBLE SHAFT CO., 178 Ontario Street, CHICAGO**

## WITTE GAS AND GASOLINE ENGINES

Positively beyond all question of a doubt, the highest type of perfection yet attained in modern gas engine construction. Every one built and guaranteed fully capable of developing horsepower claimed for it. All sizes. Horizontal type. Burns **Five-Year Bond Guarantee.** gas, gasoline, kerosene distillate or alcohol. New features: exclusively Benzolized bronze bearings; self-cleaning electric igniter; vertical self-seating valves; automatic wipe oilers. All parts interchangeable and adjustable. Quick deliveries. Write today for descriptive catalog "W" and prices.  
**WITTE IRON WORKS CO., 546 West Fifth Street, Kansas City, Mo.**

## Electrical Toys for Boys

Every Boy a Railroad President  
**Real Scientific Novelties**  
Practical, Complete, Harmless, Durable.  
JUST THE THINGS FOR CHRISTMAS  
THERE'S great fun owning a railroad and bossing the job. Our Models of Locomotives, Trains, Trolley Cars, Dynamos, Lamps, etc., are practical and durable inventions. They amuse and instruct. They point many a boy to a useful career. Equipped with dry batteries, no acids or liquids used, perfectly safe and harmless. Prices from \$1 up.  
ILLUSTRATED BOOKLET SENT FREE  
**THE CARLISLE & FINCH COMPANY**  
233 E. Clifton Ave., Cincinnati, O.  
Largest Manufacturers Electrical Novelties in the World

## Expansion Bolts



CATALOG AND SAMPLES ON REQUEST  
Star Expansion Bolt Co., Trask Ave. & 2d St., Bayonne, N. J.



## First Six Cylinder Stock Touring Car Made in America

In the fall of 1906, when we brought out the we stated in our advertising that it was—"A car which would be extensively copied in the near future." Note the number of manufacturers who are now building six cylinder cars.  
When you buy a National you have a leader  
**THE 1908 NATIONAL LINE**  
Model "T" 6 cyl. 75 H. P. Touring Car  
Model "R" 6 cyl. 50 H. P. Touring Car  
Model "N" 4 cyl. 50 H. P. Touring Car  
At the New York Show, Grand Central Palace, October 24-31  
Write for Catalog and Booklet—"What Owners Say About Their National."  
National Motor Vehicle Co., 1019 E. 22nd St., Indianapolis, Ind.  
Members American Motor Car Manufacturers' Association, N. Y.

Have you been **STUNG**  
Thousands of worthless inverted gas lights have been palmed off on the public for the  
**National Automatic**  
The only inverted Light that can give permanent satisfaction.  
It is made to serve; other kinds are made to sell. The only light having automatic control of gas under varying pressure, which insures perfect combustion.  
"National Automatic" stamped on every regulator (see arrow). Every light sold in sealed carton and guaranteed. Write for Booklet and name of local agent.  
**National Gas Light Co.**  
KALAMAZOO, MICH. Automath Regulator

**\$75 TO \$200 A MONTH**  
WANTED—Young men for Firemen and Brakemen on all Leading Railroads. Experience unnecessary; rapid promotion to Conductor or Engineer. Positions secured as soon as competent. Cut out and send this ad. today for particulars. Dept. 34  
**National Railway Training Association**  
OMAHA, NEB., or KANSAS CITY, MO.

**UNIVERSAL SCRAPER**  
Newest, simplest and best on the market. Eight sharp cutting edges, each brought instantly into use by ball joint connection. Easily locked or released by turning handle.  
PRICE \$1.00  
Send for 222 page catalog No. 18-B.  
**THE L. S. STARRETT CO., Athol, Mass., U. S. A.**

## Saves 90% THE DIAGRAPH

(Trade Mark Registered)  
The Improved Stencil Cutting Machine  
Is a saving of 90 per cent in your Shipping Room worth considering? Two Thousand Diagrams in use by the Largest Houses in the United States.  
"Indispensable in our shipping department. We had a good system before adopting the Diagraph, but this is a decided improvement we can assure you."—Petaluma Incubator Co., Petaluma Cal.  
Just a word will bring our free illustrated booklet describing the Diagraph and our "No Error" System of shipping goods.  
**American Diagraph Co., 10 N. 2d St., St. Louis, Mo., U. S. A.**

## "HOW TO REMEMBER" Stop Forgetting

MY BOOK FREE  
You are no greater intellectually than your memory. Easy, inexpensive. Increases income; gives ready memory for faces, names, business details, studies conversation; develops will, public speaking, personality. Send for Free Booklet  
**DICKSON MEMORY SCHOOL, 709, The Auditorium, CHICAGO**

## Straight Legs

Positively trim, stylish, straight-line effect with our "Pneumatic Forms. Sent on Approval. Unseen, unfelt, inexpensive, durable. "A marvelous invention." Also, without charge, exercises to give shape, force, action to the legs. Book, proofs and chart sent free under plain letter sent.  
**THE ALISON CO.**  
Dept. 62 Buffalo, N. Y.