

SCIENTIFIC AMERICAN

(Entered at the Post Office of New York, N. Y., as Second Class Matter. Copyright, 1906, by Munn & Co.)

Vol. XCV.—No. 19.
ESTABLISHED 1845.

NEW YORK, NOVEMBER 10, 1906.

[10 CENTS A COPY
\$3.00 A YEAR.]

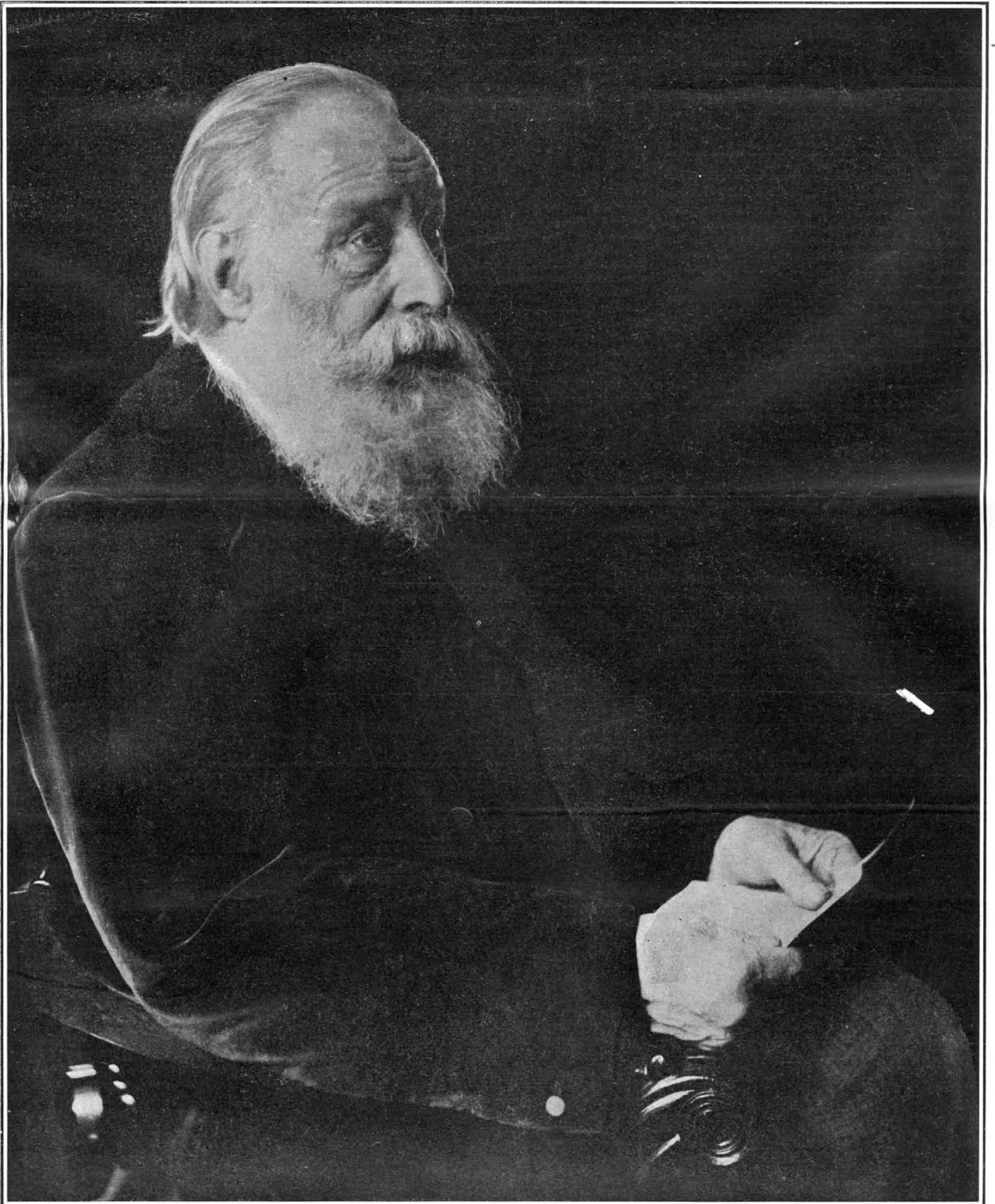

Photograph by Vander Weyde.

[See page 342.]

W. M. Perkins

SCIENTIFIC AMERICAN

ESTABLISHED 1845

MUNN & CO. - Editors and Proprietors

Published Weekly at

No. 361 Broadway, New York

TERMS TO SUBSCRIBERS

One copy, one year, for the United States, Canada, or Mexico, \$3.00
 One copy, one year, to any foreign country, postage prepaid, \$0.165. 5d. 4.00

THE SCIENTIFIC AMERICAN PUBLICATIONS

Scientific American (Established 1845) \$3.00 a year
 Scientific American Supplement (Established 1876) 5.00
 American Homes and Gardens 3.00
 Scientific American Export Edition (Established 1878) 3.00
 The combined subscription rates and rates to foreign countries will be furnished upon application.
 Remit by postal or express money order, or by bank draft or check.

MUNN & CO., 361 Broadway, New York.

NEW YORK, SATURDAY, NOVEMBER 10, 1906.

The Editor is always glad to receive for examination illustrated articles on subjects of timely interest. If the photographs are sharp, the articles short, and the facts authentic, the contributions will receive special attention. Accepted articles will be paid for at regular space rates.

THE ELECTRIC RAILROAD WRECK AT ATLANTIC CITY.

It is a most unhappy coincidence that on the same date on which we publish in the SUPPLEMENT a description of the very fine work of electrifying the West Jersey and Sea Shore Branch of the Pennsylvania Railroad, we should have to comment in the SCIENTIFIC AMERICAN upon a tragic accident which occurred soon after the opening of that road, whereby between fifty and sixty people lost their lives. As we go to press, the coroner's jury is at work upon the investigation of the wreck, which occurred on October 28, and it is too early to give any definite opinion as to the cause of the derailment, by which a whole train was thrown from the drawbridge into the water, and three-fourths of its passengers drowned in over 20 feet of water. Pending the findings of the jury and the report of other investigations which will be undertaken by experts who are qualified to judge of the conditions, it is only an act of common fairness to the company to state that this work of electrification, as described in the SUPPLEMENT, seems to have been carried out with that thoroughness and disregard of cost which characterizes first-class work. Shortly before reaching the "Thoroughfare"—a tidal estuary which flows beneath the railroad at a point about two miles from Atlantic City—the tracks of the new electric road are carried by an elevated viaduct over the tracks of the Pennsylvania and Reading line, and this work is thoroughly up-to-date, consisting of a steel superstructure carried on concrete piers. Other evidences of the high character of the work are that over a considerable part of the 65 miles from Camden, N. J., to Atlantic City, the tracks are laid with 100-pound steel, which is the heaviest weight used on any steam railroad to-day, while over the rest of the distance 85-pound rail is used. The rolling stock is also of the most modern type, and broadly similar to that which will be used on the Pennsylvania Railroad main line improvements.

The cause of this terrible accident, then, is to be sought for, not in poor construction, but in certain accidental conditions which developed at the drawbridge at the time the fatal train was crossing. The track, the bridge, and the car would seem to have been of first-class construction, and the accident would seem to have been due to some misplacement, either of the draw or the rails, or possibly to the slipping of one of the wheels on its axle—the cause to which a recent derailment in the New York Subway was attributed.

As far as one can glean the truth from the confused and contradictory statements of railway employees, passengers, and onlookers, and from the incomplete evidence at the inquest, we are inclined to think that the draw, which had been opened for the passage of a small yacht shortly before the train approached, was not perfectly aligned when the wheels of the first trucks passed from the approach on to the draw itself. That these were the conditions is strongly suggested by the reported testimony of the bridge tender at the inquest, who stated, according to press accounts, that the rails at the drawbridge buckled at times; that he had to hammer them back into place, and that he had received instructions to saw them shorter if they buckled again. This would indicate that the rails on the downgrade of the overhead crossing over the Pennsylvania and Reading Railroad track had been creeping toward the draw, and that possibly on this Sunday morning there was interference trouble between the rail ends, which prevented a proper closure of the draw and alignment of the track. In the interests of future railroad operations, particularly at drawbridges, it is to be hoped that the underlying causes of this disaster will be accurately determined.

SINGLE-PHASE ELECTRIC ROAD BETWEEN BALTIMORE AND THE NATIONAL CAPITAL.

Single-phase electric traction has come to stay. The latest evidence of this is shown in the announcement that a single-phase electric road is about to be built connecting Baltimore and Washington, D. C. Some three years ago a company was formed to carry out this project; but after the contract had been let for the equipment the plans were abandoned. Owing to the failure of the first single-phase project, a most careful engineering study was made of the conditions; and the final solution of the problem, and the construction of the road by an entirely new company, are proof of the merit of the present single-phase system. The contract for the entire electrical equipment of the rejuvenated road has been let to the General Electric Company.

The total length of the new road is about 60 miles, double-tracked throughout. The main line will connect Baltimore and Washington, and there will be a branch line, from a point on the main line near Odenton, extending to Annapolis. A very complete rolling-stock equipment will be provided for both express and local service between the cities mentioned. Nineteen express cars will be operated, each capable of making 60 miles an hour on a level track; and two heavy construction cars will be equipped, each powerful enough to haul a train of five ordinary passenger coaches at 45 miles an hour. Four of the new type General Electric single-phase railway motors will be installed to drive each of these cars. These motors will each have a capacity of 125 horse-power, and as in the case of the New Haven equipment, they can be operated not only on the single-phase electric trolley of the main line, but also on the direct-current trolley sections within the city limits of Baltimore and Washington.

Two motors of this same size will be used on the local service cars. All the cars will be equipped with the multiple-unit system of control, by means of which the cars can be operated singly or in trains, on direct current or alternating current, by one motorman. Express cars will run every 15 minutes between Baltimore and Washington, the total time being 72 minutes. Power for the new road will be purchased from the Potomac Electric Company at Washington, D. C., and will be delivered by that company to suitable substations located along the line, which will supply single-phase current to the trolley at a potential of 6,600 volts. As this is one of the largest installations of exclusively single-phase railway equipment, the construction and operation of this road will be watched with great interest in railway and engineering circles.

NEW RATING OF THE WORLD'S FLEETS.

If the system of rating the fighting values of the world's fleets adopted in the latest issue of "Fighting Ships" be correct, we must entirely revise our estimate of the relative power of some of the leading navies. France yields second place to the United States, and Germany, which before the Japanese war was considered to be at least equal if not superior to the United States, moves down to fifth position with Japan ahead of her, Russia being sixth, Italy seventh, and Austria in the eighth position. The placing of the German navy below that of Japan in an estimate of relative fighting power would seem, at the first blush, to savor of absurdity; but when we begin to examine into the basis of comparison adopted in "Fighting Ships," we find that the change has been made on grounds which are at least plausible.

This startling advancement of some of the navies and depreciation of others is due to the fact that the new system of rating is based strictly upon the stern lessons of the Japanese war, in which, during a few short months, the third greatest navy of the world was practically swept out of existence. Outside of its reassertion of the value of a trained personnel, that war emphasized the importance of the big, heavily armed, and heavily armored battleship. Furthermore, it is the unanimous opinion of naval experts that the war established the overwhelming value of the heavy, long-range gun. It proved, once more, that the final command of the sea, other things being equal, will lie with the navy which can bring the largest number of big guns to bear, when the rival fleets are facing each other in line of battle. This fact has been so far accepted that the building programmes of all navies for the present year are based entirely upon its recognition.

In the new rearrangement of the navies of the world in the order of their fighting importance, above referred to, the ships are set down in parallels of fighting value, with the battleship "Dreadnought" taken as the unit. In the estimate are included all the warships of the various fleets that are built, building, or proposed. The high position given to the United States and to Japan is due mainly to the fact that fortunately neither of these powers was affected by the agitation of a few years ago in favor of installing guns of medium caliber in the main batteries

of warships, and abolishing the 12-inch gun. As a consequence, not one of the first-class battleships of either navy carries, as its main armament, anything lighter than the 12-inch gun, while eight of our own ships mount a 13-inch piece of great power and accuracy. The German designers, however, in the ten years from 1890 to 1900, were leading exponents of the school which advocated the substitution of a lighter and handier gun in place of the then cumbersome, and comparatively slow-firing, 12-inch gun. As a consequence, every one of her battleships built during that date carries, in its main battery, a weapon which most of the leading powers to-day consider to be not even sufficiently powerful for use in the intermediate battery of battleships or the main battery of cruisers. The "Kaiser Friedrich III." class of five ships, and even the "Wittelsbach" class of five ships launched as late as 1901, mount nothing heavier than the Krupp 9.4-inch gun. Even the ten latest ships of the "Braunschweig" and "Deutschland" classes carry only a 40-caliber 11-inch piece, and there is not a battleship afloat in the whole German navy to-day that mounts a 12-inch gun.

In the "Fighting Ships" comparison the warships are rated under fourteen classes, with the "Dreadnought" as the unit; and it must be borne in mind that her high efficiency is due not alone to her ten well-protected 12-inch guns, but also very largely to her abnormally high speed. In the *First Class* the British have the "Dreadnought" completed and two new "Dreadnoughts" proposed. The United States has the "South Carolina" and "Michigan" and the new proposed 20,000-ton ship. France has nothing proposed of equal efficiency to the "Dreadnought." Japan has two new vessels proposed, and Germany none, of the same power as the unit ship.

In the *Second Class*, the British have two ships of the "Lord Nelson" type, carrying four 12-inch and ten 9.2-inch guns, and two so-called armored cruisers which will probably be an improved "Inflexible" type, carrying eight or more 12-inch guns. The United States has nothing in this class. The French have six of the "Danton" type carrying four 12's and twelve 9.4's. The Japanese have two "Akis," mounting four 12's and several 10's; the Germans two of the "Ersatz Sachsen" type, mounting fourteen 11-inch guns. In the *Third Class* the British have eight of the "King Edward" type carrying four 12's and four 9.2's, and three of the "Inflexible" type mounting eight 12's. In this class we have a very strong representation consisting of six of the "Kansas" and "Louisiana" type mounting four 12's and eight 8's; five "New Jerseys" of the same battery power, and two "Idahos," also carrying four 12's and eight 8's. France has six ships of the "Liberté" and "Republique" types carrying four 12's, and a numerous battery of 6.4's or 7.6's. Japan has two "Kashimas" carrying four 12's and four 10's. Germany has nothing in this class. In the *Fourth Class* Great Britain has twenty-five ships of the "London," "Duncan," "Warrior," and "Black Prince" types, the two last-named being cruisers. We have three of the "Maine" type and four of the cruiser "Washington" type, the latter mounting each four 10-inch in the main battery. The French have the "Suffren" and "Iena"; the Japanese nine ships, including those that were engaged in the war, two the former Russian battleships, the "Orel" and "Czarevitch," and four new cruisers, now under construction in Japan, which will carry 10-inch or 12-inch guns in the main battery. In this class Germany has a strong showing, including five "Deutschlands" and five "Braunschweigs," each carrying four 11-inch guns, besides two new cruisers each mounting eight 8.2's. In the *Fifth Class* Great Britain has fifteen battleships of the "Majestic" and "Canopus" types. We have three "Alabamas"; the French seven battleships and three powerful cruisers, and Japan three battleships, namely, the "Fuji" and two that were captured from Russia. Germany has no ship in this class. In the *Sixth Class* the British have twenty ships, including seven "Royal Sovereigns," the "Hood," two "Trafalgars," and ten armored cruisers of the "Drake" and "Cressy" types, the latter carrying 9.2's in their main battery. In this class also the United States is strong, having twelve ships, including two of the "Kearsarge" type, three "Indianas," one "Iowa," and the six armored cruisers of the "California" type. France has seven ships; Japan one; and it is to this class that, because of the light character of their armament, ten of the latest battleships of the German navy, launched between 1896 and 1901, are relegated.

It is not necessary to pursue the comparison further, but attention should be drawn to the new value assumed by that most efficient type of ship, the armored cruiser. The placing of some of these ships in the same class with the battleships is justified by the fact that in the engagements of the late war Togo did not hesitate to put his armored cruisers in the front line of battle. Under this method of rating, the author of "Fighting Ships" has placed those fine armored cruisers of our navy, the "Washington," and "Tennessee," and their sisters, in the same class with

the British battleships "Duncan" and "Formidable," the Japanese battleship "Mikasa," and the German battleships of the "Deutschland" class. In the same class also he places the British cruisers of the "Warrior" type. The compiler of these tables even prefers the "Washington," with its high velocity 10-inch armor-piercing rifle, high speed, and great coal endurance, to our own three "Alabamas," which are placed in a class below it. The high position given to our navy in this table, which has been drawn by the man who in all Great Britain has probably given the greatest amount of attention and thought to this particular phase of the subject, is an indorsement of that traditional policy of the United States navy, dating from its earliest days, which has insisted that our ships must carry the heaviest possible battery of long-range guns.

A FRENCH "JUNGLE."

The few Americans to whom European opinion concedes the possession of a sense of shame and a liking for decency, and who are supposed to have been sitting with bowed heads and tightly-clamped nostrils ever since the horrors of Packingtown were exposed, may stiffen their spines a bit—without, however, relaxing the death grip on their noses. They are beginning to learn that "there are others." All sorts of horrible stories have come from England, and now M. Martel (appropriate name!), chief of the animal inspection service of Paris, is hammering French butchers and telling them to go to Germany, regardless of Sedan and the lost provinces, and learn that the Middle Ages no longer exist beyond the French frontier. In an article in a French scientific journal (*La Science au XXme Siècle*) M. Martel, who surely ought to know what he is writing about, describes a state of affairs so primitive and repugnant, that its toleration in the twentieth century in the enlightened city of Paris seems absolutely incredible. For, singularly enough, conditions are even worse in Paris than elsewhere in France.

M. Martel impartially distributes the blame for the rudimentary equipment and exceeding filthiness of the 918 public abattoirs of France among ignorant architects, routine-enclaved butchers, careless municipal authorities, and indifferent consumers. French designers of abattoirs, he says, know nothing of the needs of the business or the importance of sanitary inspection, and are the laughing stock of the designers of foreign establishments. The French idea of a public abattoir has not changed in a century because the powerful butchers' syndicates have always maintained the principle that the butcher is master in his own shop, and may defy the inspectors.

The old provincial establishments, built long before there were any public abattoirs in Paris, are better planned than the newest Parisian abattoirs, for at first the advantage of working together was recognized. But the Parisian butcher would not abandon his private killing room, connected with his shop, except upon condition of finding precisely similar accommodations at the public abattoir. Consequently, the abattoirs have become agglomerations of private slaughter houses, in which everything is done in the most primitive fashion, and sanitary supervision is very difficult.

Many French cities, in order to avoid the expense of erecting public abattoirs, have conceded the privilege of building and managing them to individuals and corporations—most of the contracts being very disadvantageous to the city, and so drawn as to block all progress, for, as in Paris, the butchers use all their influence in favor of the system of many small killing rooms.

In France, as elsewhere, the public has remained indifferent to the cause of reform—especially the poorer classes, which are most exposed to the dangers of unwholesome meat. Last year a deputy, in proposing a law (which did not pass) for the extension of the system of public abattoirs, gave utterance to the following naïve confession of impotence: "We must content ourselves with the hope that small municipalities may recognize their duty, and invite the veterinary to inspect the private slaughter houses at the first suspicion of disease."

The average French abattoir consists of a series of stone-walled killing cells, about fifteen feet wide and thirty feet long, alternating with larger and more open halls or courts, which are used for the reception of cattle and for work of various sorts, including slaughtering when the adjacent cells are filled with carcasses. None of the great abattoirs of Paris possesses the modern appliances which are used in Germany and elsewhere for the slaughtering of animals and the dressing, hoisting, and aerial transport of carcasses. Many of the killing cells are poorly lighted, and in some of them lamps and candles must be used when artificial light is needed on winter mornings! The courts are exceedingly filthy. Here stomachs and intestines are cleaned, and their contents, with miscellaneous offal and embryos in every stage of development, are thrown pell mell on the blood-soaked soil. The drovers' dogs are allowed to feast on this

carion, through which the sanitary inspectors must pick their way to the dimly-lighted killing cells.

This appetizing picture is hardly more astounding than the information that no abattoirs in Paris, and only two in France, possess cooling or cold storage rooms.

On the other hand, the public abattoirs of Germany are, in M. Martel's opinion, models of construction, equipment, operation, and inspection. Twenty-five years ago Germany possessed few public abattoirs, but now there are more than four hundred in Prussia alone. The importance of cold storage was recognized fifteen years ago. Many of the German public abattoirs are controlled by syndicates of butchers, who appreciate the advantages of refrigeration, general killing rooms, and machine hoists and carriers. On these points, however, America has little to learn from Germany. The special merits of the German establishments consist in cleanliness and vigorous sanitary inspection.

A peculiar German institution, which has been introduced into some other countries, appears at first sight anything but attractive to American eyes. The *freibank* is a shop devoted to the public and official sale of condemned meat which has, theoretically, been made wholesome by sterilization. Sometimes the *freibank* is attached to the sanitary department of the abattoir, and is under the control both of the police and of the inspection service of the abattoir; sometimes it is in the city, in which case the supervision of the inspectors is less strict. But in every case the meat is sterilized in the sanitary department of the abattoir by methods which involve as little loss of weight and food value, and as little alteration in appearance and flavor, as possible. For example, meat which contains tapeworm larvæ is submitted to prolonged refrigeration, while tuberculous meat is simply heated to a high temperature in closed vessels.

The prices of meats sold at the *freibank* are fixed by the local authorities, and the quantity sold to a single purchaser is limited—usually to about six pounds. This restriction makes it impossible for keepers of hotels, restaurants, and boarding houses to feed their unsuspecting "paying guests" on this officially "cured" meat.

The *freibank* is rapidly becoming common in Germany, especially in the north. It is compulsory in Prussia and Saxony. In Saxony it has been gravely proposed to establish *freibänke* in the fire-engine houses in small towns. Austria, Belgium, and Switzerland are adopting the *freibank*, and it is making progress in Italy, in the face of violent opposition. In Saxony, in 1902, of each one hundred beeves slaughtered, ninety-three were admitted to unrestricted sale, and five and a half were sold at the *freibank*—the remaining one and a half, presumably, having been condemned beyond redemption. More than three million pounds of meat are sold each year in the *freibänke* of Berlin.

The *freibank* does not exist in France, and M. Martel thinks that the French idea of equality will prevent its establishment there. But he points out that the law of supply and demand creates *freibänke* of a very different sort, in which meat unfit for food is sold to customers who can not afford to buy any other. Probably we free and equal—and free and easy—Americans prefer the same system.

TULARE LAKE BASIN AGAIN FILLING UP.

Tulare Lake, once a prominent feature on all old maps of California, and at the time enjoying the distinction of being the largest body of fresh water west of the Mississippi River, is located in the extreme southern part of San Joaquin County, at an altitude of about 200 feet above tidewater. In the forties its superficial area is said to have exceeded 1,200 square miles, but in 1868 its dimensions had shrunk to 760 square miles, and twenty years later to less than 200. Occasional floods have raised the level of the lake, but the general tendency has been toward obliteration.

Originally the lake, by a well-defined outlet, emptied into the San Joaquin River, but sedimentary deposits have gradually built up a dike which obstructed the flow of waters and made of the Tulare basin an independent system of its own. The lake receives the waters of Kings, Tule, White, Waweah, Kern, and other rivers, each draining large sections of country, and in periods of flood carrying immense volumes of water. Though of great superficial dimensions the lake is extremely shallow, the deepest part being only 30 feet in depth, while evaporation exceeds 8 feet annually. Tulare Lake has for ages been the depository of all the sediment brought down from the Sierra Nevada Mountains by the rivers of the basin, which formed a soil of the greatest fertility and, but for a liability to flood, the wide plain constituting the basin would have been the site of extensive agricultural development and great productiveness.

Private enterprise aided by the State has made several ineffective attempts to re-open the barrier which prevents the surplus waters from flowing back through the old channel, and thus draining the whole basin,

but the undertaking involved dredging a channel 30 miles long and, in places, 30 feet in depth, and required an outlay of capital beyond the ability of the district to raise, though it is estimated some three-quarters of a million acres would be reclaimed and made fit for cultivation if the project were carried out.

Within the last ten years Tulare Lake has been visibly growing less in dimensions, and the belief in its permanent disappearance has become settled in the minds of those who were interested in the land once covered by its waters. Several reclamation districts were organized, appropriating 150,000 acres of the old lake bed, and a large area put under cultivation. The fertility of the land was demonstrated and immense crops were raised, the land being protected by levees and carefully drained at an expense of several millions. Faith in the future was stimulated by absence of floods, and the ease with which the surplus waters of the rivers were disposed of through the customary channels, and by the belief in the capacity of the numerous irrigating districts to consume all the waters of all the rivers which normally discharge into the lake; moreover, the rainfall of the region for over ten years had been light, and the change in the seasons seemed to have become permanent.

The present year opened with less than the usual rainfall, and more land was put under cultivation in Tulare basin than ever before. Thousands of acres which no plow had ever touched were planted to grain and fruit, and up to the first of February the outlook of the lake dwellers was most alluring. A vast amount had been laid out in permanent improvements and farming machinery, and appearance flattered the most exalted hopes of abundant crops of every description. These would have been fulfilled had not the early months of 1906 violated all precedent, and proved the most extraordinary in point of rainfall in the history of the State. Conditions were reversed. All the region included in the upper part of San Joaquin Valley was drenched with continuous rains for two months, and every watercourse emptied unprecedented floods and, having no outlet, covered the bed of Tulare Lake to a depth which submerged every acre of cultivated land within its boundaries, swallowing up all crops and improvements and utterly destroying the results of ten years of unremitting work expended by the industrious colonists. Where were once wide-spreading tracts of highly-cultivated farms there is now but a waste of waters, above which rise the ruins of great harvesters and the wrecks of homes. The loss cannot yet be estimated, but is widespread and will run into millions. There is no prospect of the lake resuming its level of the early part of the year, when not over ten square miles of land was submerged, for the rivers are still pouring great floods into the basin, and will continue to do so for the next six months, as the present high stages will be succeeded by the usual summer flood arising from melting snows from the Sierras, and is sure to be of unexampled magnitude. Observers report a depth of snow on the summit of the eastern ranges of 22 to 30 feet, extending to low altitudes, and as this will not begin melting before the month of June, the outlook for Tulare is ominous.

The general belief is that no farther attempt to reclaim the vast basin will again be tried until the old outlet into the San Joaquin River is opened, and a sufficient channel to carry any possible flood dredged.

THE CURRENT SUPPLEMENT.

The current SUPPLEMENT, No. 1610, contains an unusual number of valuable technical articles. A Koerting 200-horse-power valveless two-cycle petroleum engine for submarine boats is described and illustrated by the English correspondent of the SCIENTIFIC AMERICAN. The Editor has made arrangements to publish a series of articles on solders. The first of these appears in the current number of the SUPPLEMENT. W. B. Gump writes on the properties of the series transformer. Most valuable is Dr. Eugene Haanel's discussion of the electric smelting of Canadian iron ores. The electric railway on which the unfortunate accident at Atlantic City recently occurred is described in full, and its rolling stock illustrated. How hot-air balloons are inflated is told in a clear and well-illustrated article. Dr. Theodor Koller gives some very good suggestions on the utilization of waste materials. The Editor hopes to publish a series of articles on this subject. In the present installment the utilization of wood waste and horn shavings is discussed.

The proposal to transmit electricity generated at the Victoria Falls to Pretoria and Johannesburg is taking shape, and a first issue of capital will, it is said, be announced within the next few weeks. The distance from the Falls to the Rand as the crow flies is 600 miles, but it will be necessary to make deviations that will increase the distance to be covered to nearly 700 miles. The extraordinary pressure of 150,000 volts is proposed. At the outset provision is to be made for 30,000 horse-power, but this may be increased as necessity arises.

THE NEW DUELING SCHOOL IN PARIS.

It seems that after all the absurd so-called "duels" which we read about as having taken place in France.



A Student at the Dueling School Wears a Mask Which Will Protect Him from Injury but Which Will Enable Him to See His Target.

Germany, and Italy, may really in the near future turn out to be very lethal affairs indeed. Hitherto, if an officer, a lawyer, a journalist, or other insulted a colleague, seconds exchanged visits, a meeting was arranged, and shots fired with quite farcical results as a general rule; for ordinarily the average professional man, even in a military nation like France, is a deplorably bad shot, and there was usually no more visible result after the so-called "duel" than an amusing paragraph in the papers.

That the French mean business in the near future, however, in this matter, will be seen from the fact that regular dueling schools have just been established in Paris, as well as in Rome and Berlin and Vienna—not merely for swordsmanship alone, but also for regular practice with the long-barreled dueling pistol. The principals wear long padded overalls, and curious masks, like those of the deep-sea diver, with a very thick glass plaque in front of the face.

The "bullets" used are pellets of clay, which, however, might do very serious damage to the pupils in these remarkable academies were it not for the glass protection over the face. Lessons are first of all given in the elaborate etiquette of dueling, and next comes instruction in the necessary "deportment."

Last and most important of all comes the duel proper, with the measuring out of the ground, the loading of the powerful spring pistols with the soft clay

balls, and the aiming on the part of each combatant at a vital spot—usually the head. No doubt the knowledge that the shooting is innocuous tends to make the duelists' aim very accurate, but there can also be no question that it familiarizes a man with the entire routine of a procedure which, without this initiation, would be extremely disconcerting to the bravest.

Needless to say, the majority of the pupils by no means have real duels upon their hands; but among a passionate people like the French, quick to anger and to avenge real or fancied insult, there is no lack of attendance at the various schools, of which three or four have already been opened in the French capital. The largest of these is a handsome saloon on the first floor in the Rue Castiglione, and its séances are attended by crowds of the gilded youth of Paris, who are attracted thither by the novelty of firing direct at the living man, and watching the comedy of farcical duels, which may become very real ones at a day's notice.

COMPARISON OF A TURBINE AND A RECIPROCATING ENGINE FOR THE UNITED STATES NAVY.

Although we have been rather late in taking up the question of the marine turbine in this country, it is gratifying to know that the two most successful forms of the turbine, the Parsons and the Curtis, the former a British, and the latter an American development, are now under construction for use in American-built vessels. Of the various marine turbine installations proposed or in course of construction, perhaps the most interesting is that which is being built by the Fore River Shipbuilding Company for the United States scout "Salem." The "Salem" is one of three 24-knot ships which were authorized in 1904, and whose contract was signed in May of 1905. In designing these vessels, the government wisely determined to use the opportunity here afforded to test the relative efficiency of the turbine and the reciprocating engine in the propulsion of fast ships. The contract for the construction of two of the vessels, the "Birmingham" and the "Salem," was awarded to the Fore River Shipbuilding Company, and the third vessel was given to the Bath Iron Works, Bath, Me. The two ships which are being built by the Fore River Company, the "Birmingham" and the "Salem," will be equipped respectively with reciprocating engines and Curtis turbines, while the "Chester" will be driven by Parsons turbines. The engines of the "Birmingham" will be of the twin-screw vertical expansion type; those of the "Chester" will consist of four turbines, driving four propellers, while the "Salem" will be driven by twin-screw turbines.

These navy scouts will be 420 feet long, 47 feet 1 inch in beam, and the mean draft will be 16 feet 9 inches, on which draft they will displace 3,750 tons, the full-load draft being 4,687 tons. Each ship will be armed with twelve 3-inch rapid-fire guns and two of the new 21-inch turbine torpedo tubes. The contract calls for a speed of 24 knots with a development of 16,000 horse-power.

The accompanying engraving affords a striking comparison of one of the Curtis turbines built for the "Salem" and one of the triple-expansion marine en-

gines built for the battleship "Vermont." The turbine is of 8,000 brake horse-power and the reciprocating engine of 8,250 horse-power. A comparison of the dimensions



How the Polite Art of Dueling is Learned in France. Thus Garbed, Two Men Fire Clay Bullets at Each Other.

and weights of the two engines is greatly in favor of the rotary type.

TURBINE ENGINE.

Length over all16 feet 2 3/4 inches.
Width over all13 feet 6 inches.
Height over all12 feet 6 inches.
Length over stuffing boxes..14 feet 5 1/2 inches.
Length over all, shaft.....23 feet 7 inches.
Size120 inches.
7 stage, R. P. M.....350
Weight102 tons.

RECIPROCATING ENGINE.

Length over all.....33 feet 6 1/2 inches.
Width over all.....11 feet 3 inches.
Height over all.....21 feet 9 inches.
Length over all, cylinders..32 feet 9 inches.
Length over all, crankshaft.31 feet 1 inch.
R. P. M.....120
Weight153 tons.

The above shows that on practically every point of comparison recorded, the turbine has an advantage and particularly in the matter of length, height, and weight, being only half as long, not much over half as high, and only two-thirds as heavy. The tests on an experimental turbine, built expressly for testing this type of turbine, show that in steam consumption there is a proportionately fine economy.

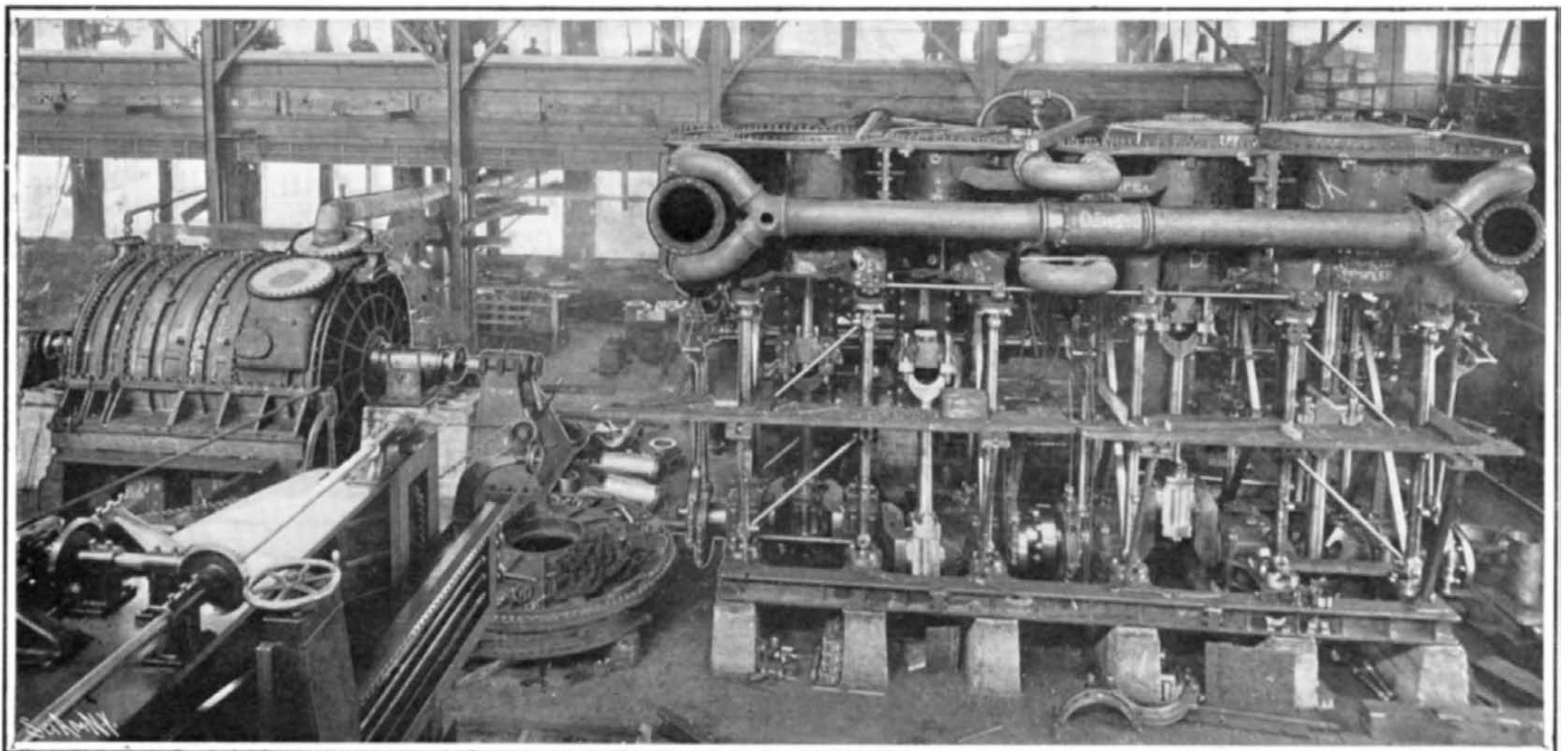

Turbine for Scout "Salem."

Length, 16 feet 2 3/4 inches. Height, 12 feet 6 inches. Weight, 102 tons.

Triple-Expansion Engine for Battleship "Vermont."

Length, 33 feet 6 1/2 inches. Height, 21 feet 9 inches. Weight, 153 tons.

AN 8,000-HORSE-POWER CURTIS TURBINE AND AN 8,250 HORSE-POWER RECIPROCATING ENGINE BUILT FOR THE UNITED STATES NAVY.

THE PARSEVAL DIRIGIBLE AIRSHIP.

BY DR. ALFRED GRADENWITZ.

The ability of steering motor-driven balloons imparts to the dirigible type a considerable military value. Endeavors have therefore been made in the German army to design a suitable type of dirigible balloon, the more so as the same problem has been recently solved with some satisfaction in the French army. The attempt derives additional importance from the fact that wireless telegraphy affords a means of communication between the airship and the commanding officers.

It may be said that whenever the propelling mechanism is disabled, the craft becomes a freely-moving balloon exposed to the caprices of the atmosphere. By reason of the great dimensions of the airship, a clever operator may even then be able, by utilizing the contrary winds that blow at different heights, to return to his starting point. The most valuable feature of a balloon as compared with other types of airship is the minimum of danger attending a landing. The main difficulty met with in designing a dirigible airship is the problem of wind currents. On account of these the proper speed of the balloon should be higher than the velocity of the wind. Whenever this is not the case, the balloon will in fact drift away. Modern racing automobiles are driven at such high speeds, despite their comparative lightness, that a solution of this problem is rendered possible. Still another difficulty is that of designing a balloon with sufficient rigidity and stiffness to deal with any propelling motor forces and to insure a sufficient stability *en route*. Without being of excessive weight the balloon body should be sufficiently rigid and solid. Moreover, the dirigible should be transportable also when empty, since it is not always possible in the case of unfavorable weather to prevent its drifting away and its collapse far from the station. The airship is therefore made up of several parts to be transported separately on carriages or railways. The rigidity *en route* is secured either by building a substantial framework into the balloon itself (in some cases even a sheet-metal cover is provided) or by utilizing the natural rigidity of the inflated balloon body. One of these alternatives has been chosen in the case of Count Zeppelin's airship, and the other in that of the Schwarz aluminium airship, which, not being transportable when deflated, are bound to be lost in the case of an unsuccessful landing. Moreover, because of the dead weight of the framework, large dimensions must be given to the gas-bag. The Rénard airship and its successors were designed much more happily, stiffening being secured by a long, detachable girder suspended below the gas-bag. A similar scheme has been adopted in the construction of the Lebaudy airship. The natural rigidity of the gas-bag in this instance is utilized to a far greater extent, the projecting portions of the gas-bag being supported by the internal excess pressure. The natural rigidity of the balloon body has been utilized to the highest extent in the Parseval airship, without subjecting the cover to higher strain than in the Lebaudy, the internal surplus pressure being 16 millimeters (0.629 inch) of water as against 20 millimeters (0.78 inch) in the Lebaudy.

Apart from the car, 6 meters (19.68 feet) in length, no provision is made for stiffening, the ease with which the airship may be transported

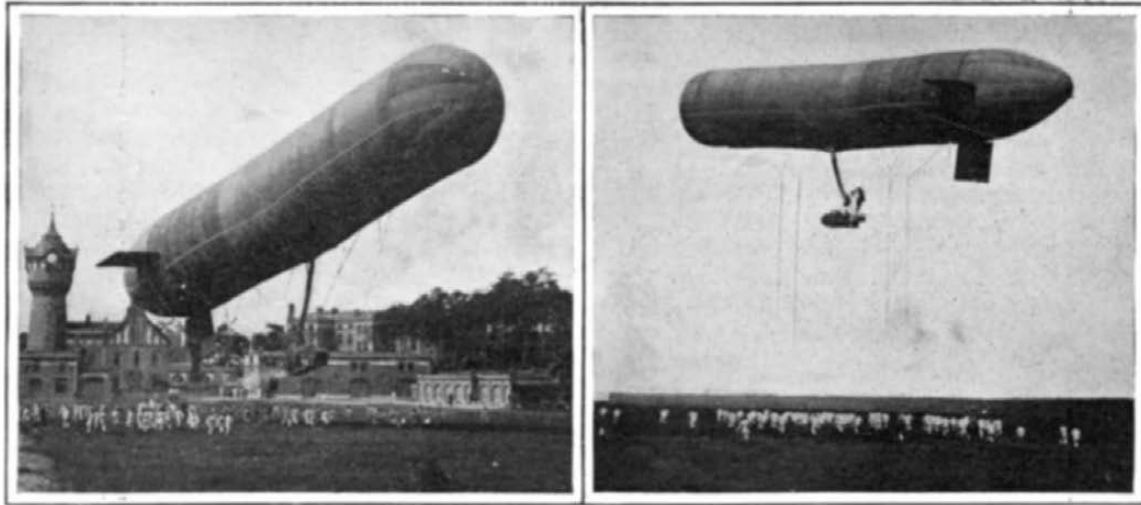

Two Photographs Taken at a Recent Ascent of Major Von Parseval's Airship.

when deflated fully warranting this method of construction. No difficulty has been encountered in obtaining the necessary staunchness. The strength of the materials used is likewise quite sufficient. In fact, the experience gained in the case of captive balloons,

be alternately filled and discharged, for trimming the airship. The power required is supplied by the engine; it is not necessary to operate a sliding weight by hand as in the case of the Zeppelin airship.

In order to increase the rigidity of the airship, the car has been suspended far below the airship.

The propeller, 4.2 meters (13.77 feet) in diameter, is situated above the car as closely as possible to the latter, being thus better protected against damage in landing. It is made up of a central frame and four blades consisting of a loose fabric. These blades have been so charged with weights as to maintain their proper shape and tension, by reason of the centrifugal forces due to rotation.

In order to prevent the balloon from being carried forward underneath, so as to cause the gas-bag to tilt upward, as the propeller is started, the car is not rigidly connected with the balloon, but is suspended so as to swing forward and backward in its central plane while maintaining its parallel position relatively to the gas-bag. As the propeller starts, the car is at first drawn forward before the balloon shares this motion, when the center of gravity being displaced in a forward direction, will compensate for the tilting action of the propeller.

Whenever the balloon is retarded by counter winds or accelerated by rear winds, this device will act in some similar way. Plunging and pitching are produced if the car is rigidly suspended. The car is free to swing without transmitting its movement to the gas-bag.

The motor transmits its power to the propeller through a double bevel gearing.

The dimensions of the balloon are: Length, 48 meters (157.48 feet); diameter, 8.57 meters (26.43 feet); capacity, 2,500 cubic meters (3,269.75 cubic yards).

Weights of the Balloon: Cover, 600 kilogrammes (1,322 pounds); car, 1,200 kilogrammes (2,645 pounds); gasoline, 200 kilogrammes (440 pounds); water, 100 kilogrammes (220 pounds); passengers, 300 kilogrammes (661 pounds); ballast, 460 kilogrammes (1,014 pounds); thrust of propeller, 280 to 300 kilogrammes (617 to 661 pounds); diameter of same, 4.2 meters (13.779 feet). The services of three men, viz.,

the aeronaut, pilot and machinist, respectively, are required to operate the craft, while two men will be sufficient after some practice. The aeronautical operation has been facilitated to a high extent by the considerable lifting or lowering forces produced, without detracting from the speed, by placing the gas-bag at a very small angle relatively to the horizontal line (up to about 5 deg.) and utilizing the aeroplane action on the upper and lower sides. The gas-bag may be thus displaced from its equilibrium by several hundred yards, and still kept far more easily at a given height than a freely-moving craft, thus insuring a considerable saving in ballast. Even if there be a consid-

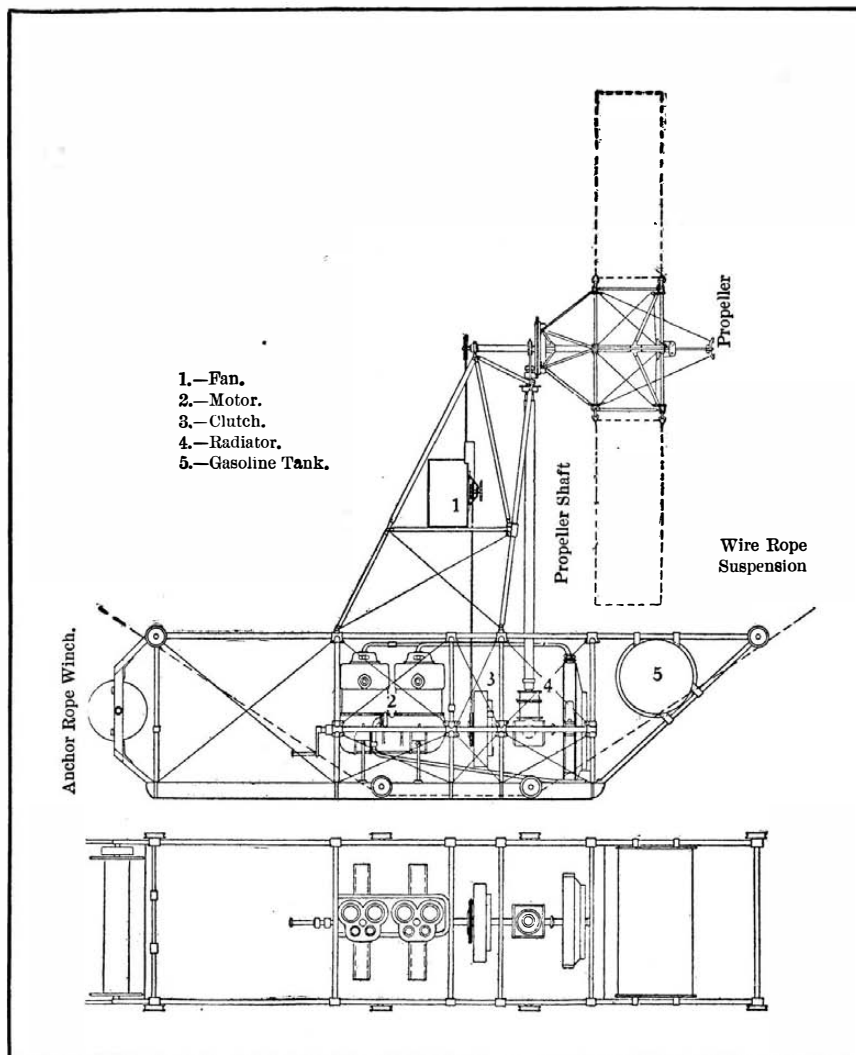
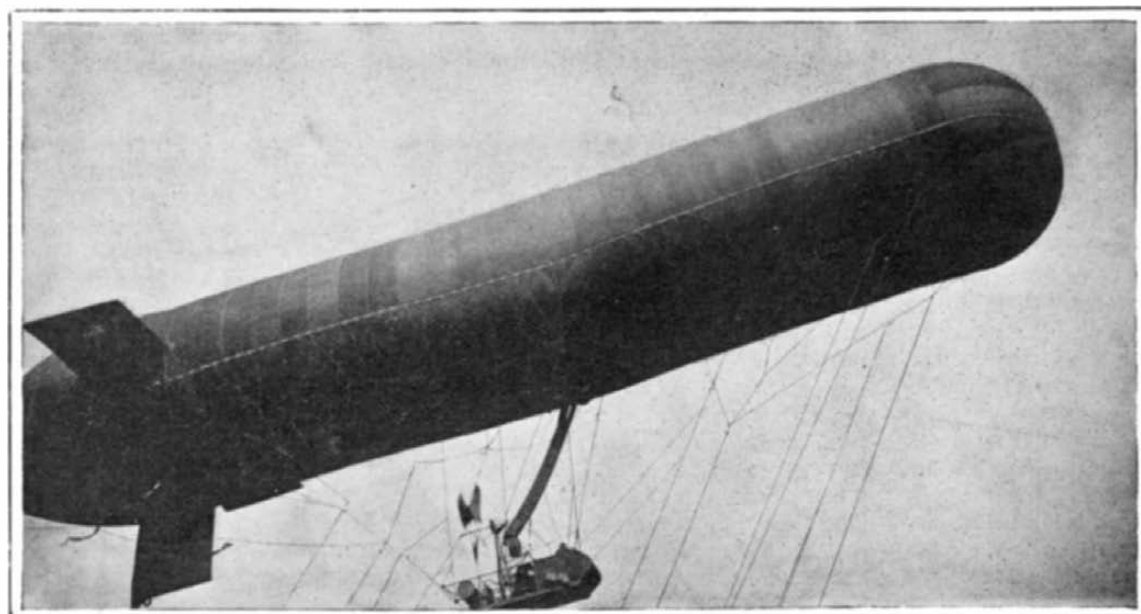

Diagram of the Car.

which must withstand much greater forces in the wind than have ever been produced by aeronautic motors, fully warrants the fulfillment of both conditions. In order to prevent any oscillations, the cylindrical gas-



A Near View of the Airship.

THE PARSEVAL DIRIGIBLE AIRSHIP.

erable excess in weight, the craft will be fit for operation as long as the driving mechanism is operative and there is a sufficient supply of fuel.

The Parseval airship has a radius of action of ten hours, which period may, however, be lengthened considerably, if the ballast consists entirely of gasoline.

The speed is placed at 45 kilometers per hour (27.9 miles), thus insuring a range of 225 kilometers (139 miles) in the case of a ten hours' operation in calm air. A few hours are required to get the craft into working order. A large two-horse wagon is sufficient to transport the airship when deflated.

Ship Elevators.

In a paper read before the Austrian Engineers' and Architects' Society, and reported in the official organ, the *Zeitschrift des Oesterreichischen Ingenieur und Architekten Vereines*, Dr. A. Riedler—speaking more particularly of the competition for designs for the projected ship lift at Preran—pointed out that the results of such competitions can never possess any widespread applicability, owing to the preponderance of local conditions influencing the design in every case. The two essential considerations, however, in the mechanical part are reliability in working and reasonable prime cost, and to these may be added as subordinate, though important, conditions, simplicity, ease of supervision, and accessibility and interchangeability of parts. So far as the engineering part of these projects is concerned, it cannot be determined beforehand with the same degree of accuracy as is possible with the machinery, but is largely dependent on subordinate circumstances, all foundations and underground construction being influenced by the nature of the ground. Nevertheless, it is possible to fix as a standard for underground construction a limit that will be seldom reached in practice, and thereby insure absolute reliability in working, by reducing the pressure, set up on the site by the structural work, to the natural pressure. This ideal cannot be realized in the case of lifts where concentric loads, deep foundations, high supporting walls, etc., are in question, at least not without great expense. On the other hand, in the case of inclined plane lifts, this broad condition can be easily fulfilled by adopting a suitable form of construction, the reliability of working being far greater than is attainable in engineering works as a rule.

The inclined plane system is also the only one that can be constructed at a low cost, but it is essential that only a single and sufficiently high speed should be used, and that the dry-haulage method should be adopted in order to save the weight of the water trough. All the plans hitherto proposed for affording an elastic support to ships when out of the water are based on an erroneous idea, and calculated to defeat their own purpose, the only reliable way being to recognize the fact that all ships undergo deformation when loaded and afloat, and to adapt the supports to the actual form of the vessel and then fix them in a perfectly rigid manner. The hydraulic press forms the best method of carrying out this idea in practice, a number of such presses being so arranged on a truck that they can be applied to vessels of different build, and the press heads covered with a ring of hemp, which is forced against the hull by a pressure of two and one-half atmospheres, the pressure at the contact surface being about one-tenth atmosphere. Then, as the truck is drawn out of the water, the weight of the ship gradually acts on the rings, and the press valves must be closed. If the presses are mounted six feet apart, the pressure in each cylinder will not exceed forty atmospheres. Each press must be operated independently, so far as closing the valves is concerned, in order that the weight may be distributed uniformly; otherwise there is the danger of bending the hull plates where the internal pressure is low, and no guarantee that the more heavily loaded parts will not bulge to a dangerous extent. No difficulty will be encountered in packing the press plungers quite tightly, leather being a perfectly reliable material.

In distributing the pressure, the plan recommended is to mount every eight presses in two double rows on a separate truck, all the trucks being attached to a through girder. Wheels running in ball bearings are indispensable, the frictional resistance being only about one-third that of roller or plain bearings. The tractive force is preferably applied by rack and pinion, the strains being less than those in the ordinary mountain railway of this type and the movement freer from jolting. Low speed electro-motors would furnish the motive power, two pairs of cogwheels being sufficient for the reducing gear. Springs on the truck wheels are not essential, the hull and track being sufficiently elastic to take up the slight irregularities in the rails, joints, etc.; and in this system no duplication of the lifting plant is necessary, since the rate of haulage can be increased to 10 feet per second, owing to the low dead weight and absence of water.

The plant for discharging the ship into the high

level water may be greatly simplified by providing a turntable (turning through an angle of 16 deg.) of the same gradient as the rest of the track, so that the train of trucks and their load can be run down into the water without change of gradient, only the direction of movement being reversed. The turntable can be operated by a couple of electro-motors at opposite sides. This arrangement dispenses with the necessity for any protecting wall at the high level, and no extensive masonry is required anywhere, the pressure on the site being no greater than the natural pressure.

Official Meteorological Summary, New York, N. Y. October, 1906.

Atmospheric pressure: Highest, 30.59; date, 13th; lowest, 29.36; date, 6th; mean, 30.06. Temperature: Highest, 74; date, 9th; lowest, 37; date, 12th; mean of warmest day, 66; date, 5th; mean of coldest day, 43; date, 11th; mean of maximum for the month, 61.8; mean of minimum, 50.4; absolute mean, 56.1; normal is 55.5; average daily excess compared with mean of 36 years, +0.6. Warmest mean temperature for October, 61 in 1900; coldest mean, 50 in 1876. Absolute maximum and minimum for this month for 36 years, 88 and 31. Precipitation, 4.30; greatest in 24 hours, 1.21; date, 19th and 20th; average for this month for 36 years, 3.70; excess, +0.60; greatest precipitation, 11.55, in 1903; least, 0.58, in 1879. Snow: Trace. Wind: Prevailing direction N.E.; total movement, 10,490 miles; average hourly velocity, 14.1 miles; maximum velocity, 58 miles per hour. Weather: Clear days, 5; partly cloudy, 10; cloudy, 16. Thunderstorms: Date, 9th. Frost: Date, 11th, 12th, 13th. Fog: Dense, date, 20th.

Automobile Omnibus Lines in Paris.

The first of the automobile omnibus lines commenced running in Paris not long ago. Experiments had been made for a long time past, and the public became accustomed to seeing the omnibuses pass along the streets, but the system was not put in actual operation until the first week in June, when the line known as the Montmartre—St. Germain des Près was started, and the eleven automobiles were used to replace eighteen

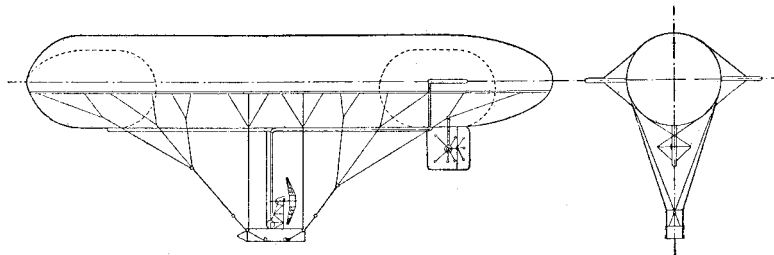

Side and Bow Elevations of the Parseval Airship.

of the old form of omnibuses requiring 194 horses in all. The time which is needed to make the trip across town, which was about 45 minutes, is now reduced to 25 minutes. These cars have been furnished by the well-known automobile firm the Société Brillié, after a sharp competition between many of the leading firms. The Omnibus Company of Paris has now ordered as many as 90 new cars, which are to be used upon six lines in the city to replace the horse vehicles. These lines will be put in service from month to month so that they will all be in operation at the end of this year. It is proposed to start up soon the second line, running from the city hall to the Neuilly gate. All the cars are built after the general lines of the company's standard double-decked omnibus.

A Bricklaying Feat.

In the erection of the House of Representatives office building, adjacent to the United States Capitol at Washington, an interesting fact has developed in connection with the brick masonry work. The first brick was laid at the site on the afternoon of July 5, 1905, and on July 3, 1906, there had been laid in the walls 11,000,000 bricks. This is believed to be the greatest number of brick laid on any building in one year in the United States, and probably in the world. One of the causes conducing to this record-breaking feat was the remarkably "open" winter of 1905-06. In those winter months the work continued almost without interruption from either snow or cold, and not more than twelve or fifteen days were lost during the entire winter by reason of weather conditions.

Water-proof glue is manufactured of gum shellac three parts and India-rubber one part by weight, these constituents being dissolved in separate vessels in ether, free from alcohol, subject to a gentle heat. When thoroughly dissolved, the two solutions are mixed, and kept for some time in a vessel tightly sealed. This glue resists the action of water, both hot and cold, as well as most acids and alkalis. If the glue is thinned by the admixture of ether, and applied as a varnish to leather along the seams where this has been sewn together, it renders the joint or seam water-tight, and almost impossible to separate.

THE STORY OF THE DISCOVERY OF THE FIRST ANILINE DYE.

BY SIR WILLIAM HENRY PERKIN.

My father was a builder. In early childhood I began to think about the choice of an occupation, and as I took an interest in everything that went on about me, I thought I should probably follow in my father's footsteps, and I busied myself with practical carpentry at every possible opportunity. I remember also that I took a lively interest in the applications of the lever, the screw, and the wedge, of which I occasionally saw practical examples. The reading of some descriptions of steam engines and the like awakened an interest in machine construction, and I spent much time in making drawings and wooden models. I was also very much interested in painting, and even had, for a short time, the foolish idea that I should like to become an artist. I believe that the practical knowledge of mechanics which I thus acquired in early youth has exerted a lasting influence upon me, and I never lost the appreciation of its value.

Shortly before my thirteenth birthday something occurred which was destined to determine my final choice of an occupation. A young friend who had a cabinet of chemical apparatus showed me some experiments of a very elementary sort, including the crystallization of soda and alum, and these experiments seemed to me so wonderful (and indeed every formation of crystals appears wonderful to me to this day) that I saw that chemistry was something far higher than anything that I had yet met with, and my ambition to become a chemist was awakened. I thought that I should be happy if I were apprenticed to an apothecary, for I could make experiments at odd times; but circumstances intervened which led to a still better result. Until that time I had attended a private school in the neighborhood, but I now left it and, at the age of thirteen, entered the City of London School. In this public school lectures on chemistry and physics were given, very strangely, during the noon recess. It was the only school in the country in which these subjects were taught. I had not been there long before the teacher, Thomas Hall, B.A., observed my great interest in the lectures, and permitted me to assist in preparing the lecture experiments. This raised me to the highest pitch of enthusiasm. I often went without my luncheon in order to find time for my work in the dreadful place that in that school was called "the laboratory."

Hall had heard a few lectures by Dr. Hofmann, and had worked with him for a short time in the Royal College of Chemistry in Oxford Street. When I was fifteen years old he had several conversations with my father, and the result was that I went to Dr. Hofmann, to study chemistry under his direction. (I am afraid that my father, although he said nothing, was displeased at the time, for I know that in accordance with his wish I should have become an architect.) I soon finished my course of qualitative and quantitative analysis, and took up research work. Strangely enough, the first subject that Dr. Hofmann selected for me was anthracene. The raw material was obtained from Mr. Cliff (the manager of Bethel's tar works). Unfortunately, Laurent had assigned to this hydrocarbon an erroneous formula ($C_{15}H_{12}$), and although I had prepared and analyzed anthrachinone (Laurent's anthracenone) and other derivatives, the figures I obtained would not fit any possible derivative of $C_{15}H_{12}$. Notwithstanding this, the experience thus acquired and the material and derived products obtained all became useful to me when I began to work on alizarine many years afterward. Dr. Hofmann next gave me as a subject the action of cyanogen chloride upon naphthylamine, and after I had purified naphthaline and made from it nitronaphthaline and then naphthylamine—operations which one had to do for one's self in those days—the remaining part of the investigation was soon finished, though it was not published until some time afterward. I was now about seventeen years old, and became an assistant in Dr. Hofmann's experimental laboratory. Before I go on I must here give expression to my profound feeling of indebtedness and gratitude to Dr. Hofmann for his brilliant method of teaching, for his stimulating enthusiasm in scientific investigation, and for the interest which he took in me during my studies.

I now come to the period connected with "mauve." As Dr. Hofmann's assistant I was occupied all day with his researches (which at that time were concerned chiefly with the phosphor bases). I therefore carried on my own work in the evening and at other spare times at home in my scantily furnished laboratory, and there it was that, in the Easter vacation of 1856, when I was just eighteen years old, I discovered "mauve." As is known, I was led thereto by an attempt to produce quinine artificially from allyltoluidine, which caused me to study next the oxidation of aniline. Now, when in experimenting with the dye-stuff thus obtained I found that it was a very stable

body that produced on silk a beautiful violet, exceedingly resistant to light—being in this respect very different from archil, which was then employed in silk dyeing—it appeared to me that it would be a useful dye if it could be produced in large quantities. But its probable cost of production made this seem almost hopeless, and such would indeed have been the case had it not possessed so strikingly intense a dyeing power. I quietly continued my investigations, sought to determine the formula for the dyestuff, etc., and at the same time I obtained an introduction to Messrs. Pullar, of Perth, who gave a favorable opinion of the specimens of dyed silk submitted to them. When the summer vacation came and I had more time at my disposal, I undertook, with my brother's assistance, technical experiments on a very small scale, in which one or two ounces of the dyestuff were produced. Then, on August 26, 1856, the process was patented. Soon afterward, during a visit to the dyeworks of Messrs. Pullar in Perth, I made experiments, in conjunction with them, in dyeing cotton and other materials. They were also good enough to take me to some print works at Mary Hill near Glasgow, where experiments in printing were begun. As the results, so far, were satisfactory and the opinion of the dye was favorable, it was decided to undertake its manufacture. Consequently, I did not return to the Royal College of Chemistry at the end of the vacation. I must confess that, after taking this step, I experienced considerable apprehension that the undertaking might prove a failure, and I was also worried by the thought that my technical work would put an end to my scientific researches.

As sufficient knowledge concerning the practical operation of the process of manufacture was yet lacking, and as the dye had also not been fully tested on large quantities of material, it was not possible to begin the manufacture on a very large scale. My father had confidence in me and in the invention, found the required capital, and joined with me and my brother in the enterprise, under the firm name of "Perkin and Sons."

After the necessary land had been acquired, the erection of the factory was commenced about the end of May or the beginning of June, 1857. As my father was an architect, the buildings were quickly erected, and by the end of the year a sufficient plant was ready for operation to enable us to begin making the dyestuff and delivering it to silk dyers. This was in December, 1857.

In an article of mine, "On the History of Alizarine," may be found the print of a hasty pencil sketch of the factory, which I made early in 1858, or less than a year after the commencement of building.*

But much yet remains to be told of the difficulties which were connected with the first commercial production of the dye, and which continued for some time longer before they were gradually overcome. At the time when we set the factory going I had no knowledge of chemical factories except what I had learned from a few books, and I had only once been, for a few minutes, inside a chemical factory, and that an alum factory. Had I, however, seen the apparatus then commonly employed in chemical manufactures, this would have been of but little value to me, because the new industry required its own peculiar appliances. As the materials were more costly and the methods more refined than those of other chemical factories, the apparatus also necessarily had to be of a far higher class and more carefully constructed. And not only this, but it had to be newly invented, and practical directions for its manufacture had to be given to the makers; for it was astonishing how little the practical men of those days could help one with suggestions of their own. The waste of valuable time caused by the delays in their work, and their imperfect understanding of the directions given them, were at times very discouraging. Luckily, I had a little practical knowledge of machine construction and mechanics, and this was invaluable to me at that time. Fortunately, also, very little, if any, of the apparatus designed failed of its intended purpose.

In the chemical part, also, many difficulties had to be overcome. The manufacture of aniline, which could then be found in but very few laboratories, was no simple matter. Benzol was not made in large quantities, and when it was obtained it was of very variable composition, so that it had to be purified. Its conversion into nitro-benzol at moderate cost likewise proved difficult. Strong nitric acid was not manufactured except in very small quantities and at exorbitant prices, and as we did not wish to engage in its manufacture, we tried a mixture of soda, saltpeter, and sulphuric acid, and in this way produced large quantities of nitro-benzol, an operation which, however, required

great care. The extraction of the dye and its purification also presented many difficulties.

On looking back at all the difficulties of the infant industry, many of them appear, in the light of our present knowledge, so insignificant as scarcely to be worth mentioning. Yet they had a very real existence in their time.

But the production of the dye was not all that there was to do. The methods of using it also had to be developed. In those days dyers were accustomed to the use of vegetable dyes only, and they did not know what to do with basic dyes like "mauve." I had to become, to a certain extent, a dyer and calico printer, and I spent much time, first in London and Macclesfield in silk dyeing, then in Scotland in calico printing, and next in Bradford in finding out how to dye half-woolen mixture with "mauve." I could not well spare this time from my own factory, but it had to be.

Verily, this dye was a pioneer, and it made the way clear for all that came after it! And what a change has come about in dye works and print works! Instead of, as formerly, jealously guarding their own secret processes, the heads of factories now expect that, on the appearance of a new dye, the chemists shall teach them how to use it.

Utilization of the Entire Cotton Plant.

According to the chemical investigations of Dr. Robert R. Roberts, of Washington, D. C., the entire cotton plant is a fiber that can be utilized. Dr. Roberts has been quietly employed on cotton fiber work for the past five years, and has just reached the stage of his investigations which would justify him in announcing the results of his discovery. He can delint cottonseed in five minutes, handing out a handful of seed that



One of the Powder Filling Houses Charging 3-Inch Shells.

A red flag is flown while this operation is in progress.

THE IONA NAVAL MAGAZINE.—II.

will rattle like shelled corn. This is done without injuring the germinating qualities of the seed, nor does it affect the value of the manufacture of oil. In this delinting process Dr. Roberts claims a saving of 75 per cent of seed waste in planting, eliminating defective seed, which will enable the Southern cotton planter to use the drill machine in planting, obviating, in a manner, the enormous expense of chopping out the surplus cotton stalks. He claims furthermore that his delinting process will effectively destroy the boll weevil, whether the eggs or larvæ are laid in the germinating point of the seed or hibernating in the form of a beetle in the loose cottonseed. The seed can be delinted, he says, for about \$6 per ton. Cotton stalks, after the ordinary process of reduction to a pulp, become by the new process in thirty-four hours a fine fiber, not as long as cotton itself, but similar in texture. This fiber, he claims, will make the finest paper in the world.

Peary's New Polar Record.

Commander Robert E. Peary has sent a message stating that he succeeded reaching latitude 87 degrees 6 minutes. This is higher than the point reached by the Duke of the Abruzzi, who held the record. Peary suffered terrible privation and hardship, battling incessantly with ice, storms, and headwinds. No deaths or illness, however, occurred in the expedition.

Peary wintered on the north coast of Grant Land and then traveled by sledge northward. Gales broke up the ice, destroyed his caches, and cut off communication with his supporting bodies. Drifting steadily eastward, however, he reached the point mentioned. On the return his party had to eat eight dogs.

THE IONA NAVAL MAGAZINE.—II.

BY WALTER L. BEASLEY.

(Concluded from page 326.)

The heart and activities of the Iona naval magazine are centered around the storage and manipulation of smokeless powder into charges for the large and small size guns of the navy, and the black for bursting charges for the shells. Some of the more important places, therefore, are the powder filling houses, four of which are in operation, situated at widely different points. These are all small, one-story, wooden structures, designed to be unpretentious and isolated owing to the possibility of an explosion. One of the accompanying pictures shows the interior of the main filling house, which presents about one of the most animated and interesting sights to be seen on the island. The men are required to wear long white serge suits and moccasins; no metal or other articles are allowed in the pockets which might in any way cause friction. All the tools, funnels, measures, cups, scales, and other appliances used are made of copper. Here the delicate and somewhat dangerous business of weighing out the various smokeless powder charges is done. Even one or two grammes difference in weight is carefully observed. At the Indian Head, Md., proving grounds the naval ordnance experts, by tests, determine the powder charge best adapted for the various guns. Also at the annual target practice similar results as to range and velocities are recorded. With the advent of new guns and the slight chemical change in the powder, the charges are subject to constant revision. This keeps the filling-house men constantly employed. Each morning the day's supply of powder is brought from the magazine in the lead-colored wooden boxes. These are zinc-lined, air-tight, and hold 100 pounds. The gov-

ernment pays seventy cents per pound for powder, and furnishes the alcohol to the manufacturers. The output of the naval powder factory at Indian Head, which is about 2,000 pounds per day, is mainly used for experimental purposes on the proving grounds. Owing to the careful process of manufacture, particularly in the final washing of the pulp, the powder is said to be equal, if not a bit superior, to that obtained from the manufacturers. The boxes of powder are emptied into a long wooden trough, and with a copper scoop it is dipped out, accurately weighed, and tied up in quarter, half, and full charges, in white bags of muslin. These bags have several wide streamers for fastening attached, and each is tagged with the date of filling and the amount of powder it contains. A small ignition charge of quick-burning black powder, to set off the smokeless, is stowed in the bottom of each bag.

They are then placed in large copper cans and returned to the magazines, where they are held in readiness to go aboard the ships. At the time of the writer's visit the big charges, 220 pounds for the 13-inch guns, were being put up. These are arranged in four quarter charges of 55 pounds each. The bags when piled on top of one another reach to the top of a man's head, and present a formidable sight of bottled-up destruction. The heaviest charge used in the navy is for

the new 45-caliber, 12-inch, breech-loading rifles installed on the "Connecticut" and "Louisiana," which is 310 to 330 pounds. As the smokeless powder, owing to various atmospheric pressures and different temperatures, absorbs moisture and undergoes a slight chemical change, all the smokeless powder is sent to the naval storage depot at Dover, N. J. Here has been established a redrying house, where the smokeless powder is placed in a series of bins or draws where, at a steady temperature, it is kept for a regular time. Three hundred thousand pounds of smokeless powder were redried here last year. No ammunition is put up at this point, it being reserved entirely for the storage of powder and high explosives. It has an ideal location for this purpose, being seven miles inland and entirely isolated.

Nearly all the powder consumed at Iona Island is sent direct from this depot.

To furnish the great number of bags for the powder charges, an extensive sewing plant is constantly kept going on the second floor of one of the ordnance buildings in the Brooklyn navy yard. Here, with an electric cutter, 50 to 100 thicknesses of muslin are cut up at a time into various sized patterns. A series of steel dies, at a single operation, cut out great quantities of the round bottoms for the bags. Thirty different sizes are made for the bursting and propelling charges, ranging from the 3-pounder to the 13-inch gun. The sewing is all done by skilled men operators, a motor being attached to each machine. The making of the large 12 and 13-inch bags, with a half-dozen wide streamers, requires an extraordinary amount of intricate sewing and manipulation. Each is deftly turned and twisted several hundred times before completion. Besides the regu-

* Journal Society of Arts, 1879.

lar bottom, each bag has an additional compartment made for the ignition charge, having a perforated center. One man turns out on an average fifteen to twenty 13 and 12-inch bags a day, and about thirty-five of the 6-inch. The longest bag made is for holding the entire 6-inch charge, about a yard long. The com-

loaded in a day. A new rotating band, to give a truer flight to shells from guns in which the rifling has been considerably worn by erosion, has been devised. At the recent target practice all shells are reported to have had a perfectly true flight. Several of the smaller filling houses are used to assemble the cart-

5 pounds, are placed on a hand power press and the projectile shoved home. The assembled shell and cartridges are then run through a gage having the same dimensions as the actual guns on board the ship. They are afterward packed in wooden boxes up to a weight of 123 pounds, and stored for shipment. With a half-



Interior of the Main Powder Filling House, Iona Island, Where the Smokeless Powder is Put Up in Bags Which Constitute the Firing Charges of Naval Ordnance.

pleted bags are stamped on the bottom with size and caliber of the gun they are intended for, then sent up to Iona Island, to be filled and stored in the powder cans. Another important operation performed in the filling houses is loading the 13 and 12-inch projectiles with their bursting charge. For the former, 50 pounds of black powder is used, and about 30 pounds for the 12-inch. To hold the shells steady and to get at the base of these huge steel missiles, weighing over 1,000 pounds each, they are roped in a sling and hoisted clear of the floor by a pulley and chain. The point is then lowered a foot or so



A Full Powder Charge for a 13-Inch Gun.

In four bags of 55 pounds each the charge of 220 pounds is stored in two copper cans.



Putting in the Bag to Hold the Bursting Charge of 50 Pounds of Black Powder for a 13-Inch Shell.

into a stout wooden frame with an opening a trifle larger than the shell. Then a long narrow bag is inserted in the shell cavity, and the measured amount of black powder is poured through a funnel into the shell. Some fifty of these huge projectiles can be

ridge cases and the bursting charges of the 3-inch rapid-fire shells used to repel torpedo attacks. While in the act of pouring in the black powder charge a red flag is kept flying. The 3-inch rapid-fire cartridge cases, after being filled with the propelling charge of

States ordnance officers are carrying on a series of tests with a new bullet which is expected to supersede the one used at present in the ammunition for the new magazine rifle. The new bullet is jacketed, but is sharper than the earlier form.

dozen new cruisers and several big battleships soon to go in commission to equip, and the regular routine work of the fleet to look after, the Iona magazine is just now one of the busiest ordnance places of the government. Owing to its superior equipment and possible enlargement, it is destined to become the most important ammunition stronghold and naval base in the country. The writer acknowledges indebtedness to Commander K. Roher, U. S. N., late Inspector Ordnance in the Brooklyn navy yard, now of the San Juan naval station, Porto Rico, for courtesies extended.

The United



Assembling 3-Inch Rapid-Fire Shell and Cartridge.



How Smokeless Powder is Handled Before It is Bagged.

CARL HAGENBECK'S NOVEL ZOOLOGICAL PARK.
BY HAROLD J. SHEPSTONE.

If there is one individual able to speak with authority on how a zoological garden should be built and conducted it is Mr. Carl Hagenbeck, of Hamburg. For half a century now Mr. Hagenbeck has been assisting in the erection of zoological gardens in all parts of

plished. At the back of the lion house, which is artistically covered all over with imitated rockwork, there is a space 60 feet wide by 45 feet deep. On three sides there are rocks which rise to such a height that no animal could possibly jump over them, while they are too steep to be climbed. The other side is absolutely open, but the animals are securely confined to

there is a distance of 30 feet. No animal could leap this, for the inclosure is so designed that it is impossible for the animals to take a running jump in that direction.

Eight lions and three Bengal tigers now occupy this inclosure. It is only right to add, perhaps, that all these beasts are tamed animals; that is to say, they



Houses and Training School for Lions, Tigers, and Elephants.



The "Zoo" is Prettily and Aesthetically Laid Out with Lakes and Fountains.

the world. He is the only individual who is prepared not only to lay out a zoological garden complete, but to stock it with animals as well. Naturally, a man who has devoted his life to the study of zoological gardens should hold opinions of his own as to how a public zoo should be designed. It has long been his wish to build a zoo after his own heart, and to-day he is happy in the knowledge that shortly his one ambition will be fulfilled. At Stellingen, a pretty little suburb of the busy port of Hamburg, he is hastening the erection of a great zoo which, when finally out of the builders' hands, will be one of the sights of Europe, if not of the world. It was the writer's privilege to spend a few days with Mr. Hagenbeck as his guest recently, and to inspect for himself this novel zoo. He also witnessed the placing of some of the lions and tigers in what is undoubtedly the most unique lion "house" ever designed and constructed.

Briefly, this wonderful zoo occupies thirty-six acres of ground, though the proprietor has arranged to throw another twenty-six acres into the park if desirable. But it is the bold and even daring manner in which it is being laid out that calls for special attention. Here you can gaze at lions, tigers, and other wild beasts appearing to the naked eye to be entirely in the open, no iron bars or netting interfering with your view. A description of the lions' quarters will give an idea of how this is being accom-

plished. At the back of the lion house, which is artistically covered all over with imitated rockwork, there is a space 60 feet wide by 45 feet deep. On three sides there are rocks which rise to such a height that no animal could possibly jump over them, while they are too steep to be climbed. The other side is absolutely open, but the animals are securely confined to

are accustomed to the presence of their keeper, who can move freely in and out among them. Should an animal by any chance fall into the ravine, it can regain its den by a series of inverted steps at one end of the ditch.

Another interesting sight in this novel zoo is the artificial mountain where ibex, mountain sheep, goats,

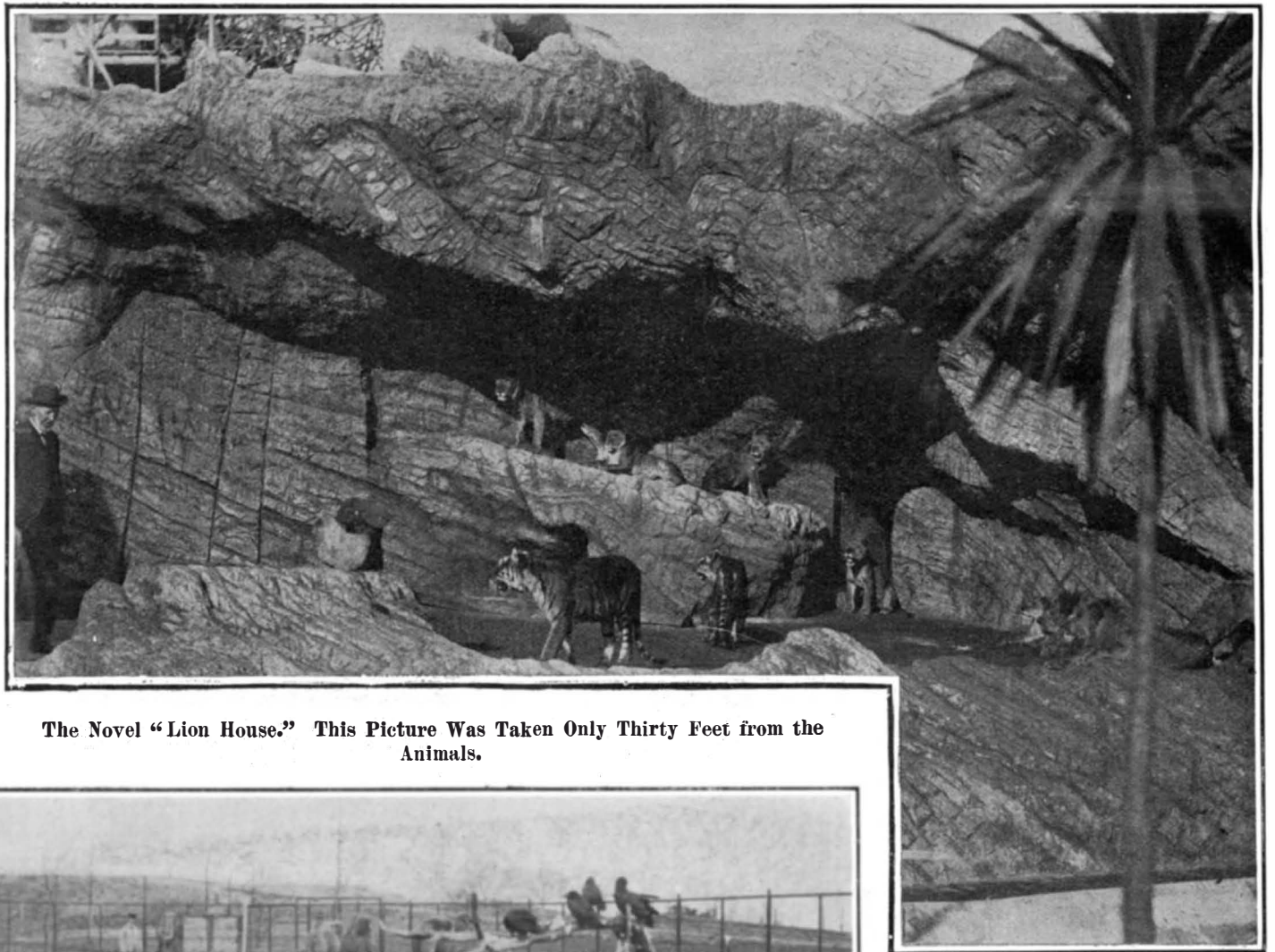

The Novel "Lion House." This Picture Was Taken Only Thirty Feet from the Animals.

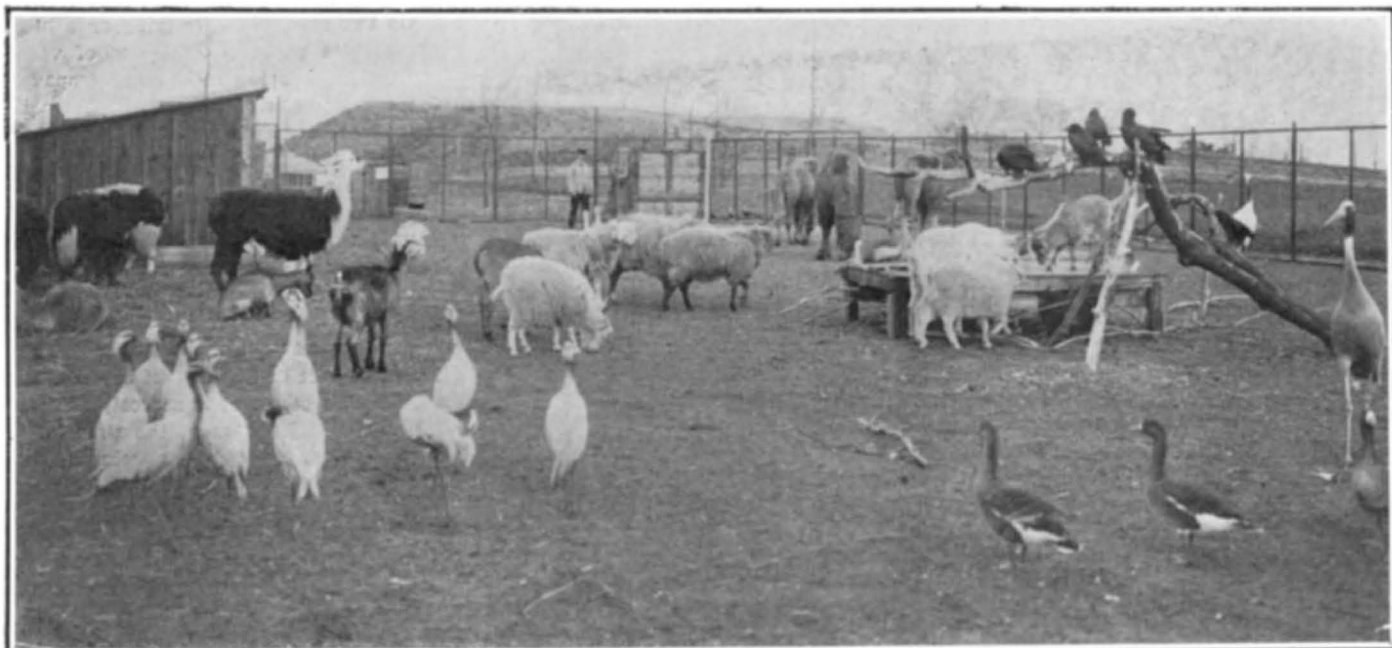

A Group Composed of Camels, Yaks, Llamas, Goats, Sheep, Cranes, Geese, and Other Birds.
CARL HAGENBECK'S NOVEL ZOOLOGICAL PARK.

and deer disport themselves. These mountains are virtually masses of imitation rocks, piled one on top of the other. In all there are some eight of these mountains, and they tower in height from 60 to 150 feet. To watch the ibex climb the steep sides and jump from one precipice to another is a fascinating spectacle. The rocks were erected by Mr. Eggen-schwylter, a very skilled Swiss expert and sculptor. A framework of timber and poles was built on pillars of brickwork. The whole structure was then covered with a layer of thick cement. The rocks are so arranged that the animals can climb to the highest points. To prevent their

slipping, small and large pieces of granite stones have been put into the cement, to afford the animals a firm foothold in climbing during frosty weather.

When completed, the garden will really consist of four distinct sections. The first of these will be devoted to all kinds of aquatic birds. The second section will be reserved for graminivorous animals. It will be replete with camels, dromedaries, yaks, llamas, ostriches, etc. The third section, now finished, is the open-air lion inclosure for the big cats. The last section is the artificial mountains which have been described, and which rise behind the lion house. On the top of the latter Mr. Hagenbeck will place large eagles and vultures, and these birds will move apparently at liberty, being only fastened by thin chains. Standing, therefore, in front of the first section, namely, the lake upon which will be placed the waterfowl, the visitor will be confronted by a wonderful panoramic view of wild animal life, for he will be able to see at one time the whole of the four sections and the animals confined within them, some 600 birds and mammals in all. This vast collection of animals will appear to be able to roam about of their own free will, for the visitor will be unable to detect the ditches and other cunningly devised arrangements that will confine the animals to their allotted inclosures.

The garden is not expected to be finally completed until April next, but when it is, there will be other novelties in addition to the panoramic view of animals already described. Not the least interesting of these will be an Arctic landscape, showing an iceberg supposed to be stranded on a rocky coast. At the foot of this iceberg polar bears will disport themselves. To the right of this there is a large basin where seals and sea-lions will congregate. Immediately behind them, on raised ground, reindeer will roam. Then there will be a group of native villages populated by races from all parts of the world. There will also be an extensive playground for children, where they can amuse themselves in gymnastics or games of all kinds. To provide further amusement for young and old, Mr. Hagenbeck will arrange that a number of elephants, dromedaries, camels, small ponies, and dwarf donkeys will be available for rides, as well as sundry vehicles drawn by antelopes, llamas, ostriches, and Shetland ponies. There will also be a restaurant and a concert room.

"My whole idea," said Mr. Hagenbeck, "is to erect a zoological garden in a natural manner. I shall place my animals in surroundings as much like their natural haunts as possible. I fully believe that hitherto animals have been too cramped in our zoos, and also not allowed enough open-air exercise. I shall give my animals here plenty of room to move about freely in their inclosures, and also keep them in the open air as long as possible. Fresh air is necessary for every living creature, and I feel convinced that one of the faults of present-day zoos is the keeping of animals in heated houses—animals, I mean, that could easily become acclimated. I feel sure, too, that zoological gardens of the future will be erected on this plan. Already, commissions from the United States, South America, and Japan have arranged to come here in the spring and inspect the park."

Some Curious Misconceptions.

BY THALEON BLAKE, C.E.

It is customary to accept without question old folks' sayings, and even popular views of mechanical operations and of chemical phenomena. A little observation, or a few experiments, will disprove or confirm many of these. The laws of physics are simple, and easily understood, yet many people, who would know better were they to think about what they so credulously accept and repeat, are deluded to an extent which would, no doubt, be laughable to themselves if they could see clearly.

For example, it is often asserted that water on bituminous coal both aids combustion, and "makes the coal last." Housewives, office men who live where this coal is used, and who are compelled to maintain stove or furnace fires, are firm believers, as a rule, in this paradox. That water on coal cannot do both, these people would know if they but thoughtfully considered it a minute. The facts are these (and any one may easily verify them): In a light fire, that is to say, a stove or house furnace, water sprinkled on large lump-coal really causes it to burn more rapidly. It soaks into the strata, into the porous surface, and,

being there converted into steam, the lump is split into parts, or the surface becomes corrugated and cavernous, thus offering a larger area of carbon to the active oxygen of the air. If the water is in excess of the amount which will do this, it then no longer aids combustion, but retards it. Again, if the coal is fine, a small dampness, nothing approaching wetness, however, may increase combustion by holding the particles apart, thus permitting the air to be admitted. In short, water on coal favors combustion, when it does favor it, only by assisting the oxygen of the air to find more ready access to the surfaces of the carbon.

Of course, where the fire is large and hot, the draft strong, and oxygen or hydrogen affinities other than carbon are in presence, then water may be decomposed into its gases = 2H + O. If the heat is extreme, unstable compounds and environment suitable, the anom-



Artificial Mountain for Ibx, Mountain Sheep, and Goats.

aly is witnessed of water causing fire to burn fiercely, with great show and crackle, by furnishing inflammable gases.

A man, who burned coke in his furnace, obtained his supply from a local gas works. He complained that the furnace was at fault. Fires were hard to make, and never grew vigorous. He told me his troubles. I asked him the color of his coke; he said it was dark. Then I recommended him to ask for dry coke. He said his coke was dry. But the interior of air-cooled coke is usually a beautiful steel-gray, water-cooled coke dark and uninviting to the eye. He investigated, and found that the workmen at the gas works sprinkled the glowing coke to cool it as soon as it was withdrawn from the retorts, thus adding



Tame Zebras Broken to Harness.

CARL HAGENBECK'S NOVEL ZOOLOGICAL PARK.

25 to 50 per cent to its weight. They "watered their stock," but honestly, as the foreman was convinced that, if anything could, water was sure to "aid combustion." The furnace was thus exonerated.

Perhaps every professional man, whose work has brought him into contact with "practical" men of the trades, has been struck with the ingeniousness of many of their "secrets." But not always does their practice succeed. To be sure, theory and practice are not synonymous; success may not come to practice based on theory. But theory is an excellent thing with which to be acquainted when practice is being investigated. I once knew a foreman of a machine shop who was positive that all he had to do to keep the demon rust from devouring steel parts to lathes, and so forth, was to dust them with quicklime. I did not like the chemical equation which ensued when calcium

oxide was exposed to air in which moisture was liable at times to permeate. But the foreman was certain; and, indeed, his steel thus protected was protected. Some other machinists in other shops and in other cities, used the same means to prevent rust. All of these said that it worked well. Many, however, either did not use it or had no faith in it. Meanwhile, the foreman of whom I first wrote, went to another shop, where he learned that there was an atmospheric condition in which quicklime did not prevent rust. He was astonished. Together we experimented. The chemical equations are: $\text{CaO} + \text{H}_2\text{O} = \text{Ca(OH)}_2$. But calcium hydroxide absorbs carbonic acid gas— $\text{Ca(OH)}_2 + \text{CO}_2 = \text{CaCO}_3 + \text{H}_2\text{O}$. It was this last H_2O which made me question the utility of thus preventing rust. We came to the conclusion that this H_2O evaporates in a dry atmosphere, and leaves no rust marks, provided that the CaO is renewed often; that it itself causes rust if the CaCO_3 is old and the atmosphere not uniformly dry; that as a rust preventer, quicklime is neither infallible nor the best under the most favorable circumstances. For it is self-evident that a substance which prevents rust by absorbing the moisture on the steel, may in the end be harmful, since it eventually gives off moisture when its final chemical transformation is consummated.

In conclusion, many ludicrous mistakes are daily committed even by persons whose educational advantages have been exceptional. A lawyer, whose scholastic career had been exceptionally long and full of honors, became the victim of a liver complaint for which, as part of the treatment, his physician prescribed calomel and soda, in tablets. The apothecary from whom he purchased the tablets placed a label on the bottle, on which was printed "Mercurous Chloride (mild), 1/10 gr. with Soda Bi-carb. 1 gr." These used, the man of many degrees, given him by colleges of note, happened to wish to buy more tablets when away from home. The second druggist furnished a label exactly like the first, except for the omission of the word "mild." The lawyer refused to take them, alleging that, as his complaint was not yet dangerous, the "mild" tablets were amply strong enough for him. No argument, no explanation which the druggist advanced had any weight with this skeptical customer. When the lawyer returned to his home, he proudly told his physician how his acuteness had penetrated the second apothecary's evident desire to substitute strong tablets for a mild kind! The distinction which *mild* was intended to convey, it is hardly necessary to explain as it will occur to all readers, is that between *mercurous* and *mercuric chloride*, calomel and corrosive sublimate, a common medicine and a deadly poison.

The habit of thinking of causes and results, of reasoning about phenomena, is what, applied to mechanics, makes inventors; applied to physics and chemistry, makes discoverers; and, lastly, applied to every-day details, makes them interesting and us ever-developing students in the mysteries of Nature and of Life.

Reactions of Bearberry Leaves.

The following reactions form a useful means of distinguishing bearberry leaves from their chief adulterants: On two rows of slides lying on a piece of white paper place drops of vanillin-hydrochloric acid and drops of fresh solution of ferrous sulphate; introduce into each a section of the leaf to be tested (it being of no consequence whether the section is thick or thin, longitudinal or transverse). In vanillin-hydrochloric acid sections of *A. uva-ursi* and of *V. vitis-idaea* develop a crimson color due to the presence of a glucosidal tannin, while those of *B. sempervirens* and *V. myrtillus* produce scarcely any color. With ferrous sulphate the liquid in the case of *A. uva-ursi* becomes bluish-black, while with the others it is scarcely colored; the section of *A. uva-ursi* becomes at the time black, that of *B. sempervirens* remaining uncolored, and those of *V. vitis-idaea* and *V. myrtillus* being darkened. It is thus possible to distinguish bearberry leaves from these possible substitutes without the aid of a microscope.—Pharm. Ztg.

A reinforced concrete standpipe, 50 feet in diameter, 106 feet high from the inside of the bottom of the tank to the top of the cornice, and with a capacity of 1,500,000 gallons, has been completed and is in service in the waterworks system of Attleboro, Mass.

A NEW STEEL-PLATE PRINTING AND EMBOSSEING MACHINE.

BY A. FREDERICK COLLINS.

In a recent issue of the SCIENTIFIC AMERICAN there was described and illustrated a new engraving machine that, under the guidance of a mere boy, would cut letters on a steel plate three times as rapidly as the most expert hand engraver. This was a very great step looking toward the production of cheap engraved stationery, but it was soon found that in order to keep up with the output of these machines, new methods must be devised in printing and embossing from the dies.

In the old method of printing from the die, after the letters have been cut into the steel block, the hand stamper makes a counter and fastens it to the die with glue; then the ink is rubbed on the die with a brush. The surplus ink on the face of the die is then carefully wiped off; for if the slightest trace of ink remains, the sheet is wasted. The sheet is next adjusted and the screw of the press turned until the die strikes the paper, and forces it up into the sunken letters. The paper is then removed and set aside to dry, when the operation is repeated. The new machine is in reality a printing press, but a wonderful one when it is taken into consideration that it inks, stamps, and delivers as many impressions in an hour as the most skilled hand stamper can turn out in a day. The mechanism for accomplishing this result is naturally more complicated than an ordinary press; but a study of the accompanying drawing and the photographs will serve to show the principles involved. As in all job presses, the machine comprises a platen on which the paper to be embossed is placed, but the bedplate that holds the die, instead of being fixed in its position, is movable, and the rocking movement of the die bedplate causes the ink-wiping mechanism to be brought into operation and the inking roller to be carried to and from its source of supply and to the die-plates. By a novel arrangement of the different parts the steel die-plate is maintained in such a position that it is in full view of the operator, except, of course, at the moment when the actual imprinting and embossing is taking place.

The frame of the machine is indicated at 1 in the drawing. The opposite sides, 2, of the bed 3 are connected by pivots with the frame through the links 4. The inner end of the bed is pivoted upon the shaft 5, the latter also serving as a bearing from the inner end of the frame 6, which carries the matrix support or impression sheet table. The inking mechanism comprises a reservoir 7, and arranged to revolve within it is the feed roller driven by a belt from a pulley on the shaft 8.

The die-inking roller includes a rod 9, having a central concentric pad portion 10, and is normally supported at its ends in the adjustable bearings 11, at the lower ends of the guide slots 12, in the opposite sides of the frame. It will be observed that the slots, while vertical at the lower ends, incline at an upward angle toward the rear part of the machine, the purpose of which is to bring the pair of curved figures, 13, straddling the rod 9, to a position so that the latter will be carried by their movement up the rearward inclines of the slot and will deposit the rod into the depressions 14, which serve as temporary bearings while the ink pad is receiving a fresh supply of ink from the feed roller (not shown in the cut). The inking roller 10 rotates upon the die-plate 15, and thoroughly and evenly inks its surface while passing beneath it.

The devices employed to wipe the die-plate to clean its surface from the ink comprises a roller 16, made of soft or yielding material mounted so that it will revolve upon the rod 17, whose opposite ends are passed through vertical slots or ways 18, in the opposite sides of the frame. Pendant connections supporting a weight 19 are provided



THE OLD METHOD OF PRINTING AND EMBOSSEING FROM STEEL DIES, IN USE FOR THE PAST CENTURY.

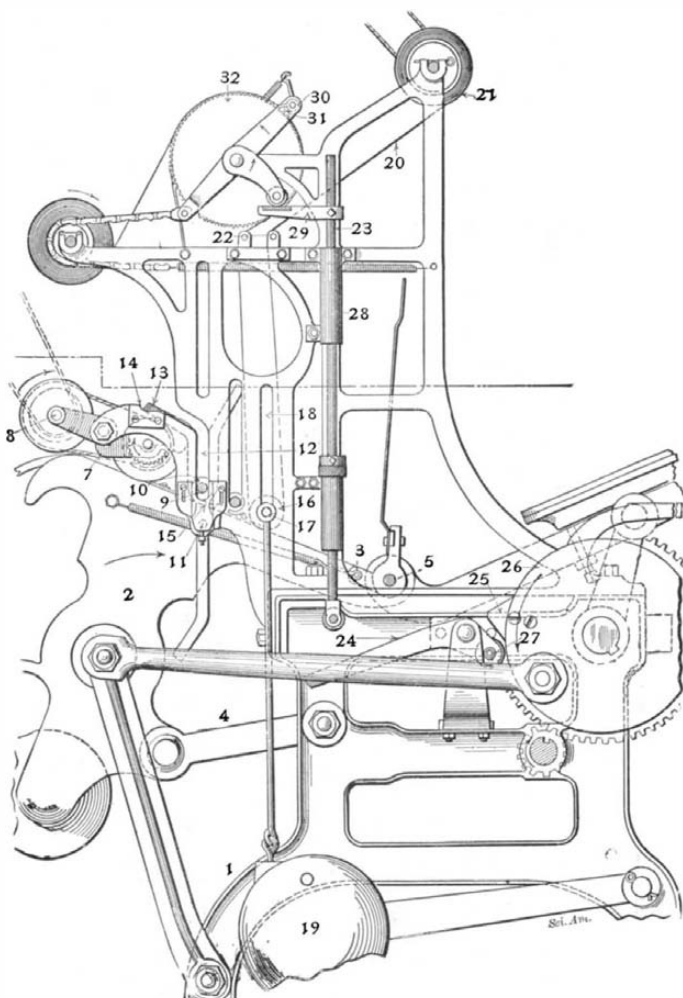

SIDE ELEVATION OF THE PRINTING AND EMBOSSEING MACHINE.

at the opposite ends of the rod 17, for the purpose of exerting a uniform pressure to hold the wiping roller against the surface of the die-plate as the paper passes under it. A strip of paper 20, from the roll 21, passes over the roller 22, and thence around the wiping roller

16, so that the wiping surface is changed intermittently. The lower end of the rod 23 is furnished with a friction roller, which is placed in a position to be struck an upward blow by the lever arm 24. The opposite end of the lever is fitted with a friction roller, and is located in the path of the cam swell 25 on the disk 26. As the disk rotates the cam swell strikes the lever 24, swinging it and thus raising the rod 23, and causing the arm 29 thereon to communicate, through a spur, a quick partial turn to the yoke rod 30, carrying the pawl 31. The latter being in engagement with the corrugated surface of the drum 32, and holding the paper fast to it, turns the drum abruptly a partial revolution against the tension of a spring, so that when the cam 25 performs its function, the paper is drawn sharply around the roller 16, and as this action is timed to occur when the roller is upon the die-plate, the surface of the latter is effectively cleaned.

In operation, the paper to be printed and embossed is placed on the platen while the machine is in the open position illustrated. When the flywheel is revolved, a pinion 7 carried by the flywheel rotates a gear, which in turn transmits its movement to the disk, and through cranks and links moves the bed carrying the die and the platen from the open position to a closed position, when the impression is made.

In this movement the rollers have been raised in their respective slots by the bed carrying the die and the extensions, while the shaft which operates the beds, striking the projecting arms, has deflected the fingers and carried the roller with its inking pad on to the feed inking roller. In the first stage of this movement, however, the die plate has passed under the inking roller, and thence beneath the wiping roller, while the cam at this moment acts in the manner above described to suddenly turn the drum, and draw a quota of paper across the surface of the roller impinging on the die. This occurring while the die is passing beneath the wiping roller acts very effectively in cleaning the ink from the die surface, and the subsequent imprint and embossment is performed quickly and without disfiguring the sheet impressed.

Employment of Atmospheric Nitrogen for the Preparation of Manures and Other Chemicals.

When barium carbide is heated in an atmosphere of nitrogen to about 1,000 degs., it is converted into a mixture of barium cyanide and barium cyanamide; calcium carbide, on the other hand, gives, under the same conditions, only calcium cyanamide. The latter substance, containing in the raw state 20 per cent of nitrogen, is considered to be as good as ammonium sulphate for agricultural purposes; in contact with moist earth and carbon dioxide it is converted by the help of certain bacteria into calcium carbonate and cyanamide, which then probably passes into urea, ammonia, and finally into nitric acid; in the absence of all bacteria these changes take place much more slowly. Calcium cyanamide may also be used as the starting point for the preparation of ammonia and its salts, of cyanamide, urea, dicyandiamide, dicyanamide, and of guanidine; it also finds application in the preparation of indigo by the fusion of the alkali salts of cyanamide with phenylglycine and in the hardening of iron. Dicyandiamide added to explosives

lowers their combustion temperatures. —Zeit. angew. Chem.

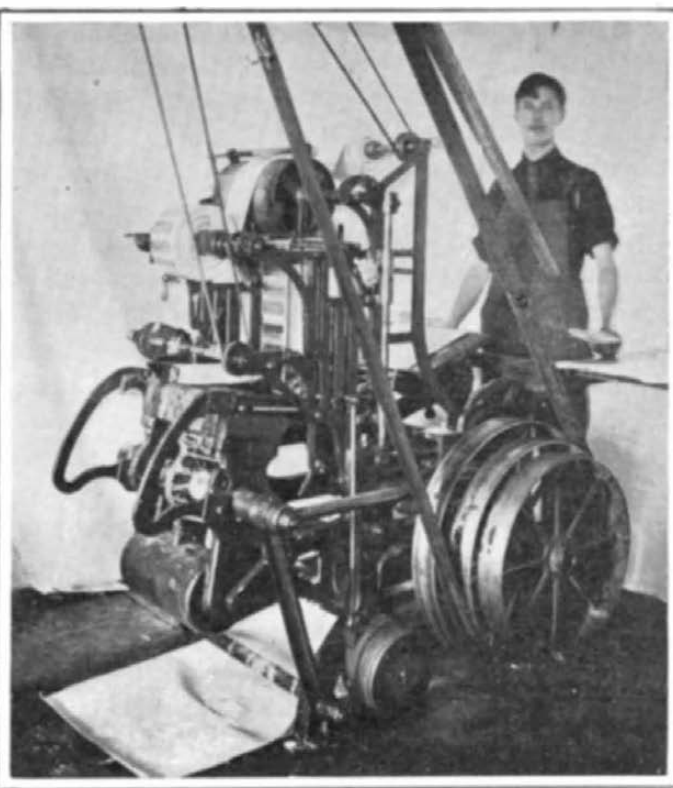

THE NEW PRESS FOR PRINTING AND EMBOSSEING STATIONERY FROM STEEL DIES. REAR VIEW OF THE MACHINE.

The largest casting ever made in the United States has recently been completed by the Bethlehem Steel Company; it is the frame for a 17½-foot gap hydraulic riveter for the Lehigh Valley Railroad shops at Sayre, Pa. It is designed for a maximum pressure of 150 tons per square inch. A special truck was required to transport the machine to its destination.

An Aid to Modern Business

By ISAAC F. MARCOSSON

There was a time when personality ruled business and gave it an imperishable tradition, when vast commercial enterprises sprang from one man's efforts and generations plucked the rich fruits of his endeavors. It was the era of the business men of the old school, the forerunners of the builders of our empire of industry. Perhaps it was some shipping prince whose fleet of clipper ships touched at far-away wharves to exchange Yankee products for the treasure of the storied East; perhaps it was a merchant king who turned cheese into dollars and ruled a dusty counting-room with an iron hand; or perhaps it was some mill lord from whose myriad looms was spun the glittering fabric of a great fortune. But whether the old master of trade moved with stately mien and ponderous gait through ship, mill, or store, his business was conducted after the very simple and unwritten law and in the good old way.

"Why bother about frills and secretaries?" said these old merchants as they made their way serenely amid the changing tides of men and affairs. Personality and integrity were the very Gibraltar upon which the unyielding structure of their fortunes were reared. There was dignity and glamor about their calling. It was a very great honor to be a great merchant. These men merged their names into the history of their times, and they turned "keen, untroubled" faces upon the dangers that hurled lesser men to their ruin. When they died, their sons succeeded them. Sons came and sons went, and old businesses seemed destined to go on forever.

But as these old merchants faded from the market-place swift changes were shaking the foundations of the *regime* that long years of fidelity had builded. A wonderful commercial expansion swept the country, uprooting all business traditions. It followed a marvelous development, the annexing of every state and country to the growing empire of business. Invention had come to the aid of business and sped it on with tingling leaps. A fleet of steel steamers succeeded every old-time clipper ship, pulsing factories rose where the ancient looms had whirred, and towering skyscrapers reared their roofs where musty warehouses had stood. Commerce followed the flag, and the nation was rushed into the thrilling race for world-trade. Fierce competition succeeded the dignified calm of the old business days, and the game was to the swift and to the quick.

But what of the character of business? Business underwent a complete evolution, and the last vestige, save honor, of the old order of things was swept away, with few exceptions. In that mighty evolution which had fairly hurled the United States far into the van of the struggle for world-commercial power the very methods of business changed. Vast volumes of trade, coupled with the many-sided phases of modern industry,

made new and exacting demands upon man's ingenuity and resource. The time had gone when one man could steer a great business through the swift eddies of competition and progress to devious paths that touched at many lands. Industries with a hundred branches; railroads that employed armies and made and unmade states; enterprises that girdled the globe,—these were the Titanic activities that man was called upon to harness.

What happened? Business became organized as never before. It became as consummate a plan of action as ever Napoleon wielded to crush the Allies of Europe. In short, business became a science that had for

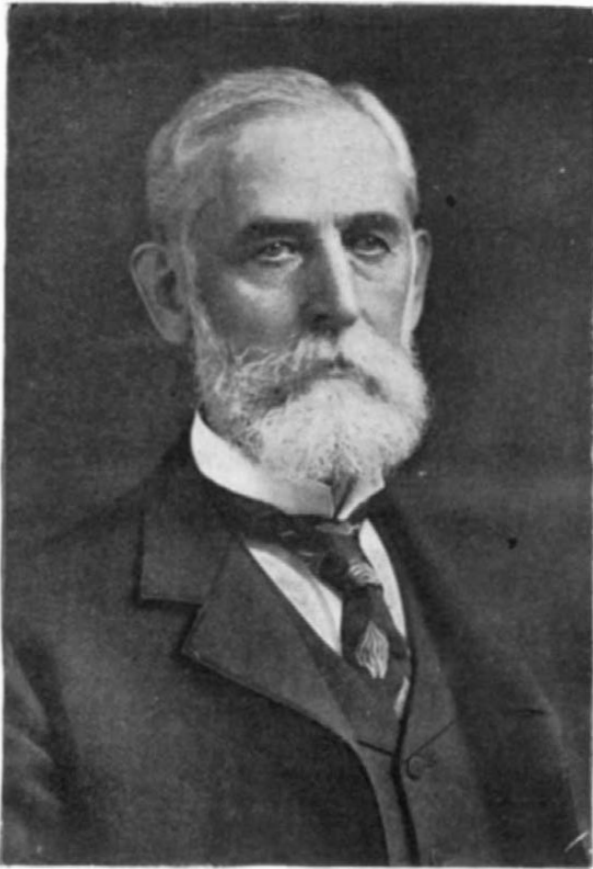

UNITED STATES SENATOR JOHN F. DRYDEN, PRESIDENT, THE PRUDENTIAL INSURANCE COMPANY OF AMERICA.

its aim the elimination of failure and the complete enhancement of financial success.

The old-time business man carried much of the plan and detail of his undertakings in his head. His business developed itself, and he merely guided it. It was a tradition that certain volumes of business, like history, repeated. But with the new science of business came the business engineer. He was the concrete symbol of an era of organization and system; a business doctor who prescribed for a business that was ill and failing, who applied strenuous remedies. He laid out business campaigns as a civil engineer laid out the route of a railroad for a syndicate. The parallel was easy. On the one hand was an untilled business field ready to be broken for a golden harvest; on the other was a virgin country to be linked with bonds of steel.

What did the business engineer do? First of all, he revolutionized business methods. He showed men how to conduct their business better than they had done before. He

showed them where waste was eating up their profits; where energy was going to naught; where concentration might increase output; and how worry, that eternal menace of prosperity and health, could be vanquished. Best of all, he did away with the old-time theory that a man had to wait six months to find out how his affairs stood. "Know how you stand every day at the close of business," said the business engineer. And he proved it. He introduced systems for the use of looseleaf ledgers and card catalogues, by which a man at 5 o'clock every day knew just what his profits and his losses were.

What is the result? No more illusions about being on the sunny side of the business street when you are in reality verging on the edge of bankruptcy.

But the business engineer did more than this. He organized great industrial enterprises so that system ruled them just as the personality of the old-time business man dominated his establishment. He took a great manufacturing company, for example, that had eighty branch stores all over the United States. He made a series of charts that covered comprehensively every phase of the business. By their use the head of the great business could sit at his desk in the morning and have spread before him the very vitals of his whole vast business. He could see what every department was doing—just how the line of output paralleled the line of sale (and this was a vastly important thing to know); he could observe at a glance just what his supply of raw material was; how many men were at work, and how they did their work. In brief, he sat there with his finger on a business pulse that throbbed in every State.

But the greatest example of business system is in the conduct of The Prudential Insurance Company, of Newark, N. J., with its practically perfect plan of handling and recording the tremendous detail incidental to the operation of six and one-half million policies all in force. With every labor-saving device known to modern business invention and convenience, the company is able to minimize its expenses. For example, it has its own complete printing plant, where all the enormous amount of supplies are printed, and where the company publications, which have a circulation of 3,000,000, are published. It has actuarial machines that turn out complete records in less than a minute. This annihilation of all unnecessary expense makes possible liberal dividends for policyholders. The system of recording has been brought to its highest development by the Prudential Company. Every detail of the great insurance undertaking is concentrated and recorded, so that any detail can be referred to without the least delay, which not only means system, but proclaims economy. Business, then, has been reduced to a

science. The man at the head of it was like a general conducting a military campaign. It was a fascinating science—instead of researchers, there were alert, eager-brained business men, searching every law of demand and supply, probing every possibility, exploring new fields of commercial conquest. In the uncertain crucibles of speculation and ambition they stirred vast enterprises into dazzling results.

Thus men built their shining structures on the vast checkerboard of business. But the grim factor Death had to be reckoned with. Man, however, had found a way to provide against the uncertainty of life, and the way was through life insurance. As business had made its mighty strides, life insurance had kept pace. As business had become reduced to an exact science, so had life insurance been perfected until its all-protecting arms sheltered a whole world. It put an infallible safeguard about the most sacred institution in the world—the home. Business men were quick to appreciate its value to them, for it became a sure and certain investment, an unerring means to economy; and the policy became a negotiable paper that was a sterling asset.

But how was life insurance to protect business as it was protecting millions of homes? The Prudential, of Newark, made it possible with a partnership policy that was destined to become an inseparable aid to business. Behind this great company was the personality of United States Senator John F. Dryden, who had founded and developed it until it became a monument of impregnable insurance protection. The joint-partnership policy was evolved upon this theory: "If men can successfully insure their lives for their families, why not insure for their partners or their business?" So the plan of partnership insurance was evolved, in which a group of men associated in business could insure themselves for each other's benefit or for the benefit of the firm, and thus guarantee the integrity of the institution.

The plan developed and put into wide and successful operation by the Prudential is as simple and economical as it is far-reaching in its beneficial effects. Brown, Smith, and Jones, for example, are engaged in business in New York. They are healthy, insurable, and their business prospers. One day Brown says to his partners:

"What would happen if one of us died suddenly?" In the midst of life, with success smiling at them from every side and the future beckoning alluringly before them, this

was not a pleasant prospect. There was a pause. Then Jones said:

"I guess there would be great confusion and no one would know where he stood."

Presently Smith remarked: "We'd have to take in another partner, I suppose."

But Brown broke in at this juncture: "I have a remedy for this contingency which is liable to come any time and when we are least prepared. Let us take out a Prudential joint-partnership insurance in favor of the business. Then things will go on all right, no matter what happens."

So they took out a Prudential partnership policy. Brown was thirty-nine years old, Smith was forty-two, and Jones was forty. Each took out a policy for \$10,000. The beneficiary for the \$30,000 of insurance was the firm. The combined annual premium was \$993.10, which was paid out of the firm's sinking fund as a legitimate expense.

What was the result? From the day those policies reposed in the firm's safe, a keener confidence pervaded the business that was like tonic to the partners. The whole foundation of the business seemed safer and surer. These men knew absolutely that no matter how suddenly death might stalk among them the business which they had reared with patient hands and hopeful hearts was immune from disintegration, which the death of one of their number might have caused.

But the insurance was not the only benefit that this group of policies bestowed. They had also the confidence and the constant satisfaction that protection afforded. There was still another. Their credit was enhanced. One day an opportunity presented itself for a business deal of considerable scope. A sum of money beyond that in hand was necessary, and since the greater part of the firm's available security was employed, the partners were in a quandary. Suddenly Jones had an inspiration.

"How about our partnership policy and the loan which the Prudential will make to us?" he exclaimed.

"Sure enough," replied the partners. It was put into the breach and was a ready security; the money was secured and the deal was consummated, the profit secured, and the loan restored.

Then one day the tragic news was flashed to the office: "Smith is dead." He had passed away suddenly in the night. In the ordinary course of events which follow such a misfortune there would have been endless confusion and a yawning gap in the business, to be instantly filled at any cost or the result to the

firm would be serious. Ready money is always necessary at such times. Long experience has taught that in these crises \$10,000 in available cash is worth more than ten times that sum at any other time, for it is sometimes difficult to convert assets, however valuable, quickly into cash. That is why so many rich men have large policies which provide ready money in just such emergencies. But in the case of Smith there was the Prudential partnership policy, which was the ready wedge ready to be driven straight into the emergency. There was a check for \$10,000 the next day; it bridged over all troubles, and permitted no menace to the integrity of the business.

But assume that the partners lived. The benefit would be just as great. Since the elusive Elixir of Life remains undiscovered, the uncertainty of earthly existence menaced these men as all other mortals. Yet the policy girded them with confidence and granted them immunity from worry. No matter what happened, they were protected. The policy, therefore, represented at all times, not only a safeguard, but an infallible asset for the realization of money and the building up of credit. If one of the partners, or all of them, retired from business, the policies could be changed so as to make the wives the beneficiaries. The protection was continuous. Thus, life insurance has taken its place as essential to the safe and systematic conduct of business—a first and last aid to the business man.

The value of life insurance remains unimpaired. When President Dryden, of the Prudential, at his own request, was summoned to appear before the Armstrong investigating committee in New York he declared on the stand, in answer to the question why his company maintained a large surplus, that it represented security,—the first and unalterable purpose of the company. As the ratio of mortality and the expense of insurance are lessened each year, so does the attitude of the company toward its policyholders become correspondingly more liberal.

We have seen how life insurance maintains the integrity of business. So does it in a larger sense preserve the unity of the American home. It makes possible those vital forces that provide the bone and sinew of our national life. Viewed in the light of our civilization, it has taken a high and unimpeachable place in the destiny of the nation. For in the perfect security of the people lies the real hope and safeguard of the democracy.

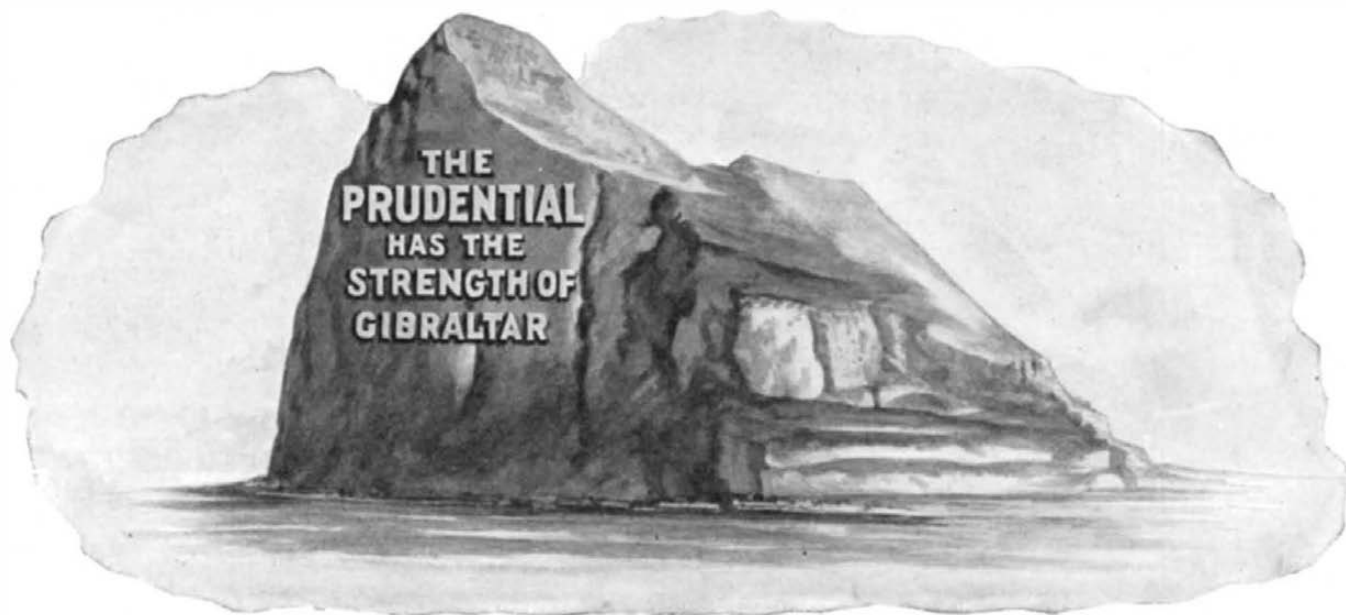

RECENTLY PATENTED INVENTIONS.

Electrical Devices.

HIGH-POTENTIAL INSULATOR.—L. STEINBERGER, New York, N. Y. In the present patent the invention has reference to high-potential insulators and admits of general use, but is of peculiar service upon transmission-lines employed for conveying currents of high potential from one point to another distant therefrom.

SPARK-GAP AND MUFFLER THEREFOR.—A. E. HARRISON, New York, N. Y., and C. M. HASLETT, Jersey City, N. J. The invention relates to spark-gaps of the kind used in wireless telegraphy and in relations analogous thereto, the more particular object being to provide an improved form of muffler for inclosing the spark-gap so as to reduce to a minimum the annoyance caused by sound proceeding therefrom.

Of Interest to Farmers.

BAND-CUTTER AND FEEDER FOR THRESHING-MACHINES.—T. L. CUMMINGS, Spencer, Iowa. The invention is an improvement in band-cutters and feeders for threshing-machines, and it provides means for feeding bundles from either or both sides of the machine, comprising two feed-aprons revolvably mounted upon a trackway and adapted to be swung to the front or the sides of the machine.

COTTON-CHOPPER.—H. T. JOHNSON, Timmonsville, S. C. The purpose of the invention is to provide a machine for chopping out young cotton-plants wherein a hoe will be automatically given a rotary chopping action as the machine is drawn over the ground and to provide a machine which will be simple, economic in construction and which will have few parts and those not liable to get out of order.

REPLANTER ATTACHMENT FOR CULTIVATORS.—O. FROMAN and J. C. CAVE, Edna, Kansas. The object of the inventors is to provide an attachment readily applied to any cultivator and operated by the operator either by hand or foot and to so construct the device that a person operating the cultivator may instantly and accurately drop a set or a hill of corn or other grain in a lost hill and to add to one thinly planted and cover the same while the field is being cultivated.

Of General Interest.

BLOCK-MOLD.—J. A. GIBSON, Buffalo, N. Y. Means provide for automatically separating the walls of the mold when the lifting-frame ordinarily employed is raised and for accurately replacing the mold-walls in proper position for receiving the molding material when the frame is lowered and the mold placed on the pallet. Means provide for securing cores to the pallet so there will be no projecting handle or the like to interfere with smoothing off the top of mold, thus necessitating use of a heavy tamp, and also a hopper for directing material into the mold and preventing loss thereof.

ADJUSTABLE SHELF.—B. J. WHITCOMB, Kennebunk, Maine. The object in this case is to provide details of construction for a device which are simple, practical, convenient in adjustment, and that enable the secure attachment of a shelf horizontally between stiles of window or door casements which may be of different widths and permit the instant removal of the shelf without the use of tools and also without injuring woodwork of window or door frame.

CAMERA.—W. H. WALLACE, New York, N. Y. The aim is to produce an arrangement to enable a camera to be focused upon a sensitized plate or film by means of an auxiliary focusing-screen, the general purpose being to enable a camera of one compartment to be used in this way without admitting injurious light to the sensitized plate and without necessitating the operator's perceiving the image actually formed at the position of the sensitized film.

PLASTERING DEVICE.—N. C. PETERSEN, Perth Amboy, N. J. In the operation the casing is to be filled with plaster and then the device is to be moved upward along the wall, and as the toothed wheels project forward of the casing and engage with the wall they will impart a rotary movement to the spreader, so that the plaster will be forced out through a cylinder opening, and the smoothing-plate will impart an even surface to the plaster.

LEACHING-TANK.—C. VOELKER, Helena, Mont. The invention refers to improvements in leaching tanks or apparatus for pulp, the object being to provide in the leaching-tank a simple and novel device to prevent the packing of the pulp, thus permitting the free circulation of the leaching liquid.

SNOW GUARD AND FENDER.—H. N. SIEGER and R. H. SIEGER, Slatington, Pa. In this case the invention pertains to improvements in guards or fenders to prevent snow from sliding from a roof, an object being to provide a device for this purpose that will be simple in construction, light in weight, and yet strong. The guard may be made of any suitable metal and have any ornamentation desired.

DRILLING-TOOL.—A. C. SHUSTER, Arroyo Grande, Cal. The object of the inventor is to provide a tool arranged to permit fishing up of a lost bit, to prevent injury to the drive-pipe shoe or pipe by the socket of the bit, and to allow the drillings to pass up away from the cutting edge of the bit to prevent clogging

of the same and to permit it to be readily turned in the well.

PLASTIC COMPOSITION.—J. E. BECK, New Orleans, La. The product has when warmed a strong adhesive quality, which enables it to be applied and adhere to canvas, burlap, etc., which serves as a backing, and to be so treated as to form any geometrical or other figure or appearance of blocks, etc. It may be utilized without the backing as a covering for floors and walls, also for wainscoting. To produce a substitute for linoleum, the required thickness of the material having been applied to the backing, the same is run through a hydraulic press to give it solidity and coherence.

FILLING APPARATUS.—W. H. SHEFFIELD, Hobart, N. Y. The object of the inventor is to provide an apparatus more especially designed for filling milk and other liquids into a number of bottles or receptacles moved intermittently over a stationary table, the arrangement being such that the waste or loss of the liquid is reduced to a minimum and the receptacles are accurately and uniformly filled to desired height. It relates to apparatus shown and described in Letters Patent formerly granted to Mr. Sheffield.

FASTENING DEVICE.—C. B. LONGENECKER, Philadelphia, Pa. The improvement relates to fastening devices for garments or other purposes, and is particularly useful in connection with closures where it is only possible to use direct vertical pressure or pull in fastening or unfastening the clasp. The object is to provide a clasp which can be attached to the fabric without difficulty and will not easily tear loose therefrom, which can be fastened or unfastened by simple manipulation and which strongly resists all lateral pull.

TURPENTINE BOX AND SPOUT.—S. G. LEWIS and V. J. WARD, Millard, Fla. The invention relates to means for attachment to pine trees for the collection of sap known as "crude turpentine," and has for its object means consisting of a peculiar face or spout adapted for ready attachment to the tree under the usual scoring of its bark, and a peculiar tank or box detachably supported by the face or spout, the tank or box having a hinged cover provided with an opening leading thereunto.

BANJO.—W. B. FARMER, New York, N. Y. The object here is to provide a banjo or similar instrument arranged to produce an exceedingly sharp, clear, and yet very melodious tone when the instrument is played, to allow of convenient loosening of the membrane with a view to relieve it of undue tension after playing and while the instrument is not in use, and to permit of readily adjusting the membrane to bring it into proper relation to the frets in case the neck of the instrument should warp.

PROPELLER.—J. CROWTHER, Dallas, Ore. The invention refers to propeller-wheels, and has for its object construction whereby minimum power is required for its operation and which shall be fashioned, affording improved results over similar wheels as heretofore constructed. The results are obtained by constructing the blades of flat sheet metal, having their front edges sharpened the better for cutting weeds and other entanglements, and by fashioning the rear portion of the blades into wing-like form with the same disposed projecting rearwardly at an angle to the front portion of the blade.

ASSORTER AND WASHER FOR SAND AND GRAVEL.—P. P. CHEMELEFF, Moscow, Russia. The invention pertains to apparatus for washing, sifting, and assorting sand used for filling water-filters, for concrete-works, and the like, and also for gravel and other granular materials of all kinds. Further objects are to separate sand from gravel and to thoroughly clean all kinds of granular material from dust and fine particles.

FENCE-POST.—R. R. BUETO, Slaughter, La. Mr. Bueto's invention is an improvement in the class of metallic fence-posts which are provided with means for anchoring them in the ground. The anchor plate has a central opening and provided at its opposite ends with flanges bent down at a right angle to enter the ground, and made of a uniform width throughout their lengths whereby their flat edges at the lower ends of the flanges are provided to prevent rocking or tilting of the plate in the ground.

Hardware.

HAMMER.—H. C. LYON, Howard Lake, Minn. The invention relates more particularly to hammers of the magazine type, which carries and supplies nails in position for driving. The device enables the workman to supply and drive with one hand, leaving the other hand entirely free to hold or place the work. This allows such operations as shingling and lathing to be carried on with great speed.

SASH-LOCK.—C. S. WRAY, Highland Mills, N. Y. Mr. Wray's invention relates to sash-locks such as are used on sliding sashes for locking the same to the window-casement. The object is to produce a sash-lock of simple construction which will not become inefficient from wear under constant use.

Heating and Lighting.

GAS-METER.—A. S. J. WEIR and T. J. HENNING, San Diego, Cal. The improvement is in the class of so-called "diaphragm" meters, in which the casing is divided by a central ver-

tical partition into equal compartments, each containing a bellows or expandible diaphragm adapted to alternately receive and discharge a certain volume of gas and connected with valves controlling the alternate inlet and outlet of gas and also connected with a register whereby gas passing through the meter to the house service-pipe is accurately measured.

Household Utilities.

WINDOW-SCREEN.—T. LANDSBERG, New Brunswick, N. J. The object of this inventor is to improve the arrangement of window-screens which are provided with means for automatically returning them to folded position. It is the object also to so construct and arrange the screen and its coating parts that the connection between the screen and the window frame will be such as to insure at all times the exclusion of flies and other insects.

ROCKING-CHAIR.—J. E. NUTTER, Ferris, Texas. Mr. Nutter employs a base for the chair of special construction, working upon which are specially constructed rockers, between which and the seat are disposed special cushioning devices for the seat. The movable portions are easy working and practically noiseless in operation, and capable of being readily taken apart and again put together.

Machines and Mechanical Devices.

SPEED-INDICATOR.—E. H. RIORDAN, Idaho City, Idaho. The invention refers to talking-machines; and its object is to provide an indicator arranged to enable a user of the machine to conveniently and quickly adjust the speed of the motor, and consequently that of the record, to insure playing of the record-piece in proper time.

VARIABLE-SPEED DRIVING MECHANISM.—R. M. RUCK, 44 Thurloe Square, South Kensington, London, England. The invention relates to variable-speed driving mechanism, more particularly such as used in transmission of power from high-speed motors; and the object is to provide apparatus which shall combine the advantages (with regard to positive driving and graduated alteration of speed ratio) and avoid the disadvantages (with regard to shock and slip) incidental to the use of toothed-wheel gearing and of conoidal friction-pulley variable-speed mechanism.

BOTTLE-LABELING MACHINE.—A. HANKE, Jersey City, N. J. The improvement pertains to label-affixers, and its object is to provide a machine more especially designed for conveniently and quickly applying labels to bottles while filling and corking the same, the label-affixer being actuated by and in unison with the filling and corking devices.

ICING-MACHINE.—P. S. GULFORD, Portland, Ore. By means of this invention the cakes to be iced are supported during the different operations of icing, turning, and drying upon forks connected to an endless carrier having its course of travel arranged to pass cakes through the various positions required by such operations.

LUBRICATOR.—C. E. MCCAFFREY, Winsted, Conn. The lubricator is more especially designed for use on the steam-cylinders of rock-drills and other steam-actuated machines and arranged to prevent leakage and waste of the lubricant, to insure regular feed of the lubricant in predetermined quantities, and allow of readily refilling without stopping the machine to which the lubricator is applied.

STRIPPING AND CLEANING MACHINE.—E. BEHRENDT, Manila, Philippine Islands. The invention relates to machines for stripping and cleaning the leaf-sheaths or band-like material from the abaca and the like plants—such as shown and described in application for Letters Patent of the U. S., formerly filed by Mr. Behrendt. The object is to provide a machine arranged to cut and break the pulp to separate the latter from the fiber and to remove the pulp previous to winding the fibers on a roller or spool.

MACHINE FOR DECORATING DISHES.—C. E. BELL, Kittanning, Pa. One purpose here is to provide a machine whereby decorations may be stamped wherever desired upon dishes, one operation only of the machine being necessary to effect the decoration. Another is to provide a machine whose construction essentially comprises a plunger-operated stamp-support, to which stamps or pads carrying the design are applied, and guide-supports for the dish to be decorated.

ANIMAL TRAP.—H. H. STICK, Glenville, Pa. The trap is especially adapted for catching animals of varying sizes, from a rat to a small dog; and consists of a cage having a double floor and opened at both ends, the ends being closed when the trap is not set by spring-operated doors. The upper floor is made in two parts hingedly connected together, which, through the intermediary of a novel trigger mechanism, springs the trap and closes the door or doors by the weight of the animal.

FEED DEVICE FOR THE INKING-RIBBONS OF WRITING-MACHINES.—A. STEINER and R. REIN, Berlin, Germany. Means are furnished for feeding the inking-ribbon in writing-machines in which the two vertical spindles carrying the ribbon spools are each provided with a ratchet-wheel, with which engage the pawls rocking in horizontal planes, while the ribbon spindles rotating in horizontal planes feed the ribbon lying in a vertical plane. By the displacement of an adjustable bar the ratchet-wheels are thrown out of gear

by means of pawl mechanisms alternately oppositely set, this displacement part being arranged between the rocking lever and the ratchet-wheels.

Prime Movers and Their Accessories.

BOILER.—H. KELLER, Chattanooga, Tenn. The invention pertains to stationary and locomotive boilers, and provides a sectional front end ring and door for the same, the end ring being arranged to provide for expansion and contraction with a view to prevent breaking or cracking of the sections, at the same time rendering the end ring air-tight and allowing ready removal of the sections when worn out and replacing the same by new ones.

BOILER-FURNACE.—P. JACKSON, Macon, Ga. The object of this inventor is to provide a furnace capable of using coal, mill refuse, bagasse and the like as a fuel and arranged to insure a complete combustion of the burning fuel and to utilize the heat to the fullest advantage with a view to economize in fuel and to quickly generate steam without danger of burning the boiler-shell.

ROTATING MOTOR.—H. J. DABONVILLE, 2 Rue Bellefond, Paris, France. The subject of this invention is a system of rotating motors; and it consists of a rotating compression and expansion motor of progressive and variable speed, reversible or non-reversible, and capable of being driven by steam, compressed air, water, gas, or any liquid or fluid. The principal characteristic is the mounting on the motor-shaft of a loose crown moving in a cylinder under the impulse of the motive power acting on wings or pistons articulated on the loose crown.

VALVE-GEAR FOR STEAM-ENGINES.—C. W. CRAWFORD, Brazil, Ind. The present invention has for its aim to provide a gear for steam-engines arranged for producing reduced clearance, silent action of the valve when running the engine at a high rate of speed, quick positive opening and closing of the valves, and keeping them stationary when closed. It relates to gears described in the application for Letters Patent of the United States formerly filed by this inventor. Mr. Crawford has invented another valve-gear for steam-engines arranged to permit of running the engine at a high rate of speed, to insure a proper working of the inlet and exhaust valves without danger of undue wear, and to reduce to a minimum the clearance-space of the piston relative to the admission and exhaust ports.

AUTOMATIC PRESSURE-RETAINING VALVE.—A. ASHCRAFT, Fort Smith, Ark. The design of the inventor is to have the improvement take the place of the well-known hand-operated pressure-retainer, one object being to automatically retain a predetermined amount of braking pressure in the brake-cylinder of a car, locomotive, or tender, and to produce a device absolutely under the engineer's control.

Pertaining to Recreation.

AMUSEMENT DEVICE.—O. HENRICHSEN, New York, N. Y. One purpose here is to provide an amusement device so constructed that objects—such as yachts, boats, or swimmers—may be individually moved at the surface of the water with more or less speed through the medium of a motor controlled by the instrumentality of lung-power or exhalations of individuals playing the game, whereby to afford amusement in the form of racing and secure benefit by reason of the lung exercise obtained.

GAME APPARATUS.—E. BAWDEN, New York, N. Y. In the present patent the invention has reference to game apparatus, and the more particular object of the improvement is the production of a chance-controlled mechanism provided with means for keeping the record of the scores made by the several players in the game.

GAME APPARATUS.—J. E. HERON, Meeteetse, Wyo. The apparatus is adapted to represent the game of life to the players, wherein the aim of all the players is to pass without impediment to a given goal, but wherein through the incidents of the game retrograde and advance movements are necessarily present, due to factors and movements which represent prosperity, sickness, or accident.

Pertaining to Vehicles.

BICYCLE ATTACHMENT.—S. J. TAYLOR, Grants Pass, Ore. The improvement is especially adapted for attachment to ordinary bicycles, thus making a cushion-frame without change in the frame proper. It does not weaken the frame proper and adds but little to the bicycle weight and can be attached to any chain-bicycle. It can be put on or taken off whenever desired and requires no alteration whatever in the original frame.

PNEUMATIC-TIRE SHIELD.—J. H. LOWREY, Neola, Iowa. In this case the object is to provide a durable shield to be applied to the pneumatic tires of automobiles and other vehicles to protect against injury to the tire, increase the tractive adherence to the road, so as to successfully travel over ice, snow, and mud or climb hills without slipping, and prevent accidents occurring by reason of front wheels failing to respond to the guiding influence of the steering-gear.

NOTE.—Copies of any of these patents will be furnished by Munn & Co. for ten cents each. Please state the name of the patentee, title of the invention, and date of this paper.

Business and Personal Wants.

READ THIS COLUMN CAREFULLY.—You will find inquiries for certain classes of articles numbered in consecutive order. If you manufacture these goods write us at once and we will send you the name and address of the party desiring the information. In every case it is necessary to give the number of the inquiry.

MUNN & CO.

- Marine Iron Works. Chicago. Catalogue free. Inquiry No. 8448.—Wanted, addresses of manufacturers of small articles which sell retail at from 1 to 5 cents. "U. S." Metal Polish. Indianapolis. Samples free. Inquiry No. 8449.—Wanted, a sharpener for mowing machines. For bridge erecting engines. J. S. Mundy, Newark, N. J. Inquiry No. 8450.—Wanted, rivets for use on demerity braces. Sawmill machinery and outfits manufactured by the Lane Mfg. Co., Box 13, Montpelier, Vt. Inquiry No. 8451.—For manufacturers of gas engine indicators. Make Alcohol from Farm Products.—New book, \$1.00. Spohn & Chamberlain, 123 S. A. Liberty Street, N. Y. Inquiry No. 8452.—Wanted, manufacturers of frost-proof shipping cases for shipping vegetables such as celery, etc. I sell patents. To buy, or having one to sell, write Chas. A. Scott, 719 Mutual Life Building, Buffalo, N. Y. Inquiry No. 8453.—Wanted, the name of the manufacturer of a bolt clipper called the "Champion." Metal Novelty Works Co., manufacturers of all kinds of light Metal Goods. Dies and Metal Stampings our Specialty. 43-47 S. Canal Street, Chicago. Inquiry No. 8454.—Wanted, a brush for cleaning soiled or stained oranges. The celebrated "Hornsbys-Akroyd" safety oil engine. Koerting gas engine and producer. Ice machines. Built by De La Vergne Mch. Co., Ft. E. 138th St. N. Y. C. Inquiry No. 8455.—Wanted, an apparatus using denatured alcohol for heating and lighting. Headquarters for new and slightly used machinery. Liberty Machinery Mart, 133 Liberty Street, New York. Inquiry No. 8456.—Wanted, a small battery and motor outfit adapted to run a sewing machine. Manufacturers of patent articles, dies, metal stamping, screw machine work, hardware specialties, machine work and special size washers. Quadriga Manufacturing Company, 18 South Canal St., Chicago. Inquiry No. 8457.—Wanted, name and address of the manufacturer of the Thomas Arithmetic Machine. Inquiry No. 8458.—Wanted, manufacturers of selenium cells. Inquiry No. 8459.—For manufacturers of a machine for making wooden meat skewers.

Notes and Queries.

HINTS TO CORRESPONDENTS.

Names and Address must accompany all letters or no attention will be paid thereto. This is for our information and not for publication. References to former articles or answers should give date of paper and page or number of question. Inquiries not answered in reasonable time should be repeated; correspondents will bear in mind that some answers require not a little research, and, though we endeavor to reply to all either by letter or in this department, each must take his turn. Buyers wishing to purchase any article not advertised in our columns will be furnished with addresses of houses manufacturing or carrying the same. Special Written Information on matters of personal rather than general interest cannot be expected without remuneration. Scientific American Supplements referred to may be had at the office. Price 10 cents each. Books referred to promptly supplied on receipt of price. Minerals sent for examination should be distinctly marked or labeled.

(10192) H. W. L. says: Is it possible to heat radiators as here shown (Fig. 1)? Use only one pipe, which drops 8 inches in 150 feet to a trap. Attach live steam at 80 pounds pressure between trap and radiators and have air cocks on top of each radiator.

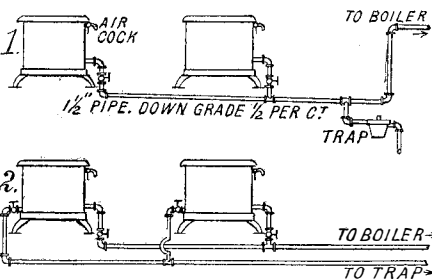

A. We think that it would be possible to heat radiators in the manner in which you describe, provided the proper apparatus is installed. A much better system, however, is shown in accompanying sketch (Fig. 2).

(10193) C. E. D. writes: Your conclusion about the spoon in the freezing mixture sounds rational. If the facts had been as you assume, I would never have written in the first place. Unfortunately for your view of the matter, the facts are as I stated and not as you assume. You ought to be able to get chipped ice at any soda fountain, which, liberally flavored with sugar and fruit juice, is pleasant eating on hot days. You can therefore both experiment and refresh yourself at the same time. I again repeat that if the spoon is cold (as it can be readily made by stirring the mixture), ice will scarcely freeze to it if allowed to stand still in the mixture for a while; but if the spoon, warm from the mouth, gas jet, or other source of heat, is inserted in the mixture, and allowed to stand

motionless for a second or two, the ice will freeze to it firmly and in large amount. Try it yourself. The reason for this behavior, which I have observed so often, is what I am seeking for. A Silver is by far the best conductor among the metals. Its specific heat is small. From these two facts it may be inferred that a hot spoon will soon cool to the temperature of ice, and will melt a little but not much ice in cooling through a wide change of temperature. A cold spoon on the other hand will not melt any ice. Now the thin film of water melted by the hot spoon is quickly frozen again in the mass of ice, and in freezing attaches the spoon to the ice, since the film of water is in contact with the spoon which melted it from the ice when the spoon was thrust hot into the ice. The ice is thus frozen to the spoon. Now the cold spoon thrust into the ice comes to the temperature of the ice, and melts no ice. There is no reason why it should have ice attached to it. There is no water on the spoon to be frozen, and no way for the ice to freeze to the cold spoon. Chipped ice and fruit juice is not a freezing mixture as you imply. Its temperature cannot be in the open air below the freezing point of water. It cannot of itself freeze the spoon to the ice, nor would the spoon freeze to the ice unless the ice was quite dry.

(10194) B. B. calls our attention to an error in the comparison of the sensitiveness of ordinary lantern-slide plates with that of carbon velox, appearing in Query No. 10775 of the October 13 issue. It is stated in the answer to this query that lantern-slide plates are no more sensitive to light than the ordinary carbon velox. Our correspondent considers this reply incorrect, and states that a lantern-slide plate is about twenty times faster than ordinary carbon velox paper. He finds that with a negative of ordinary density placed twelve inches from a lamp, only about one second or even a fraction of a second is required to secure a good impression, using the ordinary standard developer, while for a velox carbon print something like twenty seconds, with a negative at the same distance from the lamp, would be needed.

(10195) V. B. A. asks: 1. How many volts does a 500-ohm induction coil give with two dry batteries in the primary? A. The output of an induction coil is not rated in volts, but in the length of spark which it will give. You say "a 500-ohm induction coil." We do not know what that means. The voltage in the secondary of a transformer is obtained by multiplying the voltage of the primary current by the ratio of the windings in the secondary to those of the primary. You may get an idea of the effect you can obtain with two dry cells. These have about 1.5 volts each. You have 3 volts at your disposal. If you have 100 turns in your primary and 10,000 in the secondary, you will have 100 times 3 volts in the secondary, or 300 volts. So of any other numbers. 2. How can the number of volts be regulated when used as a medical coil? A. The volts may be regulated by increasing or diminishing the number of cells in the battery. In a medical coil the volts are not changed. The magnetizing effect of the primary on the secondary is controlled by either slipping a metal tube between the primary and the secondary, or by withdrawing the primary from the secondary, till the discharge can be borne. 3. How large a coil would it require for wireless communication for 3 miles, and what SUPPLEMENT describes it? A. SUPPLEMENT 1527 describes a coil giving a 4-inch spark, which will probably communicate over 3 miles of water.

(10196) A. H. asks: Having the rods of 1/4 iron running through storage battery rooms, tried to overcome the action of acid fumes by covering them with asphaltum, but find it is not invulnerable. A. There is nothing better than asphaltum to withstand the corrosive action of acids. When it gives out, put on another coat.

(10197) F. W. L. asks: Will you please explain where we get the right or authority for the use of the cross in place of the word number. Have never seen in any publication, either book or otherwise, any explanation of its use. A. We are not able to trace the origin of this very useful sign. Perhaps some one of our numerous readers may have some information upon this matter.

(10198) A. H. A. asks: I am fond of mathematics, but have to work daytime, and only at nights I can study. I have tried hard to solve the following problem by calculus, but have been unable to get the correct answer. Will some of your able readers kindly explain in your Notes and Queries and oblige? The problem is as follows: In a given rectangle 20 feet long and 10 feet wide, to lay another rectangle diagonally, the inner rectangle to be 2 feet wide; what will be the maximum length?

(10199) E. R. asks: Can you give an explanation for the following phenomenon? While out hunting last week at half-past five in the morning a severe snow storm came up. We were on a small lake about a quarter of a mile from shore. It was still quite dark. My companion called my attention to a "light" on the end of his gun. I did not see it from my end of the boat. A few moments later I reached in my pocket to get my watch, and I saw that on each of my fingers there was a

small luminous spot, as if the finger had been touched with a phosphorus match. Thinking that I had matches in my pocket I reached in again, took the watch out, and saw that the watch was covered with small spots. There were no matches in the pocket. I dropped the matter, thinking there must have been some there on the previous day, but when I put on my woolen gloves the same light appeared on the tips of the fingers of the gloves. On some fingers it was about an inch in the air, apparently suspended from a loose hair. Looking down into the boat I saw that there was no such light on my feet, but when I raised my foot higher than my head it appeared there. I have never seen anything like it before and could not believe that my observation was correct. I verified it, however, by holding my hand out to my companion and having him point to the lights where he saw them, which was exactly in the same places where I saw them. When he raised his gun in the air vertically the light at the tip became larger, and on moving nearer I could see it distinctly. Once I thought that I smelled ozone, or the characteristic odor of the static machine, on drawing my hand nearer my face. Of this I am not quite certain. I have never seen or heard of anything similar to this and would be obliged to you if you could inform me what it was. A. Your observations concerning the electricity in the air during the storm when you were in a boat are interesting. Sailors call the light seen in this way St. Elmo's Fire. It may be seen in storms at night on the tips of the spars of ships. You will find it described in books. The air was so highly charged with electricity that it charged your person by induction, and fire streamed from the tips of all articles about you. While your feet were below the gunwale of the boat no discharge could take place from them, since electricity does not readily enter the interior of hollow things, but when you raised your foot above the edge of the boat the fire of the discharge appeared upon the tip of your boot.

(10200) C. L. M. asks: 1. In "Home Mechanics for Amateurs," a description is given for making an electric furnace to be used with a 110-volt lighting system current with 20 feet of German-silver wire used for resistance. With a 250-volt circuit how many feet would be required? A. The furnace in "Home Mechanics" uses three arcs. With 250 volts a proportionate number of arcs are required. We should, however, use only 5 arcs with 250 volts and 50 feet of wire. 2. It also states that six or eight 32-candle-power lamps might be used for resistance. If these were used on the 250-volt circuit, how many would be required? A. If your 32-candle-power lamps are for 250 volts, no more will be needed than for 110 volts. You cannot use 110-volt lamps single on a 250-volt circuit. They will burn out. Two can be put in series with a resistance added to take up 30 volts. 3. Could an arc be run with a storage battery? A. An arc light can be run with storage battery by having half as many cells in series as the voltage used by the arc, namely, 25 cells.

(10201) H. B. M. asks: 1. Would it be possible to revolve a glass plate 20 inches in diameter at 50,000 revolutions per second? A. It is very safe to say that no glass disk could hold together to be revolved at anything like the speed you name—50,000 revolutions per second. We do not think any known material can stand it; nor do we know any machine which produces this velocity. 2. A transformer having 400 turns in its primary of No. 14 B. & S. with a core 15 inches long and 2 1/4 inches in diameter, and 800 turns of No. 28 B. & S. in its secondary; the primary is excited with an A. C. of 100 volts, 60 cycles. What ought the secondary voltage be? It is used as a step-up transformer. A. A transformer with 400 turns in primary and 8,000 in secondary will raise the voltage of the primary twenty times. Thus 100 volts primary will become 2,000 volts in the secondary. 3. I have an induction coil which gives a spark of 2 inches when operated on D. C., but when the vibrator is screwed down and a suitable A. C. is passed through, it gives little or no spark at all. What is the trouble? A. We are not able to tell you what the trouble is in the action of the alternating current on your induction coil. The current may not be as "suitable" as you think it is.

(10202) J. B. asks: Please be so kind as to give an explanation of the following phenomenon: The moon appears larger when near the horizon than at the zenith. A. The moon appears larger when near the horizon than all other heavenly bodies and measurements on the surface of the sky. From the horizon ten degrees up toward the zenith is apparently much farther than from the zenith ten degrees toward the horizon. A sextant destroys the illusion, for to it a degree measures the same in any part of the sky. It is agreed by scientists that the apparent increase in apparent distances is merely an optical illusion. All distances seem longer if there are many intervening objects. Distances on the surface of the ocean or on a treeless plain are thought to be less than if there are objects scattered along the way. This idea is well worked out in Todd's "New Astronomy," which we can send for \$1.50. To an astronomical instrument the moon measures a trifle larger when in the zenith, since then it is nearly 4,000 miles nearer to us, than when it is on the horizon.

INDEX OF INVENTIONS

For which Letters Patent of the United States were Issued for the Week Ending October 30, 1906, AND EACH BEARING THAT DATE

[See note at end of list about copies of these patents.]

Table listing inventions and their patent numbers. Includes items such as Acetylene generators, feeding mechanism; Acid apparatus for making nitric acid; Actuating device, fluid operated; Aerial flight means, for O. Chanute; Aerial transportation system, marine; Air brake apparatus; Air drying apparatus; Amusement apparatus; Angles, adjustable tool for constructing; Animal trap; Arbors, holder for main wheel; Ash pan; Automobile alarm signal; Automobile operator's garment; Ax edge protector; Axle, automobile driving; Axle lubricator, automatic; Balers, block inserter for hay; Bandage; Bath cabinet, electric light; Bed cover support; Bed, folding; Bed, invalid; Beer case hinge; Belt and suspenders, revolver; Belt shifter; Belt, woven; Belting, leather; Bench clamp; Billiard table, convertible; Binder, loose leaf edger; Biscuit cutter; Bit and bridge attachment; Blanks, drawing; Block forming machine; Blow-off device for condensation water; Blowing engine; Boiler; Boiler stand, range; Boiler tube and flue scraper; Boiler tube cleaner, automatic; Bolster, body; Bottle, non-refillable; Bottle, non-refillable, C. Williams; Bottles and the like, locking means; Boxes, containers; Box cover holder, adjustable; Brake apparatus; Brake beam; Brake mechanism; Brake rod; Bridge, truss; Brooder; Brush; Bucket, dumping; Buckle, harness; Building block; Building block molding apparatus; Bulletin board; Burglar alarm; Butter mold or tray; Button, cuff; Button fastener; Button, tufting; Cable grip; Calking material; Car bolster; Car, combination freight and dump; Car coupling; Car coupling; Car fender; Car handling and dumping apparatus; Car, W. Keefer, reissue; Car stake; Car stake, adjustable; Car uncoupling mechanism; Car underframe construction; Car wheel; Car wheel; Car wheel, noiseless; Car wheel shoe; Carbueter; Carburetor; Card, record or index; Carpenters' benches, work support for; Carpet stretcher; Carving machine; Cell, precipitating; Cement, Neuburger & Witz; Cement, and the apparatus therefor, manufacture of hydraulic; Centerboard; Central separator; Chair; Chair lounge; Chart, skirt drafting; Chest for mechanics' tools, carrying; Chuck, G. Rothenbacher; Chute, spiral; Clay product drier; Cleaning device; Clevis for plows; Clock, secondary electric; Clothes hanger; Clothes support, extensible; Clutch; Clutch and speed controlling device; Clutch device; Coal handling implement; Coaling ships from colliers, apparatus for; Cock, angle; Coil former; Coils, case for loading; Coin sorting and stacking apparatus; Collar, horse; Collodion and recovering the solvents of nitrocellulose or cellulose, machine for producing threads from; Coloring matter for producing silk-like or pearl luster effects; Column, veneered; Composition of matter; Composition of matter and making same; Compressors, unloader for compound; Compressors, unloader for single acting; Condenser, exhaust; Conduit elbow; Conduits, base for supporting switches and the like upon; Conduits, means for holding receptacles and the like to; Controlling device; Controlling device; Copy holder; Copying press; Corkscrew, hand; Corn gathering and husking machine; Corset stiffener; Cotton cleaner and feeder.

Inexpensive Classified Advertisements

Advertising in this column is 50 cents a line. No less than four nor more than ten lines accepted. Count seven words to the line. All orders must be accompanied by a remittance. Further information sent on request.

SALE AND EXCHANGE.

FOR SALE.—Engine lathe, swings 9/16 in. takes 25 in. between centers; complete with full set change gears to cut all size threads, 3 to 40 in.; price only \$41.00. Address L. F. Grammes & Sons, Allentown, Pa.

BUSINESS OPPORTUNITIES.

WANTED.—A few people to learn bookkeeping and pay for tuition from their earnings after we place them in positions. You can learn at your own home in a few weeks without loss of time or money. We guarantee it. Write for full information and our free book, "How to Succeed in Business." It tells you how you can better your position and make more money. Commercial Correspondence Schools, Drawer 300E, Rochester, N. Y.

STEEL WHEELS to fit any wagon or cart. Made any size, any width of tire. Also handy wagons with low wheels and wide tires. Wood wagons with steel wheels, or steel wagons with steel wheels. Log wagons and heavy traction wagons of all kinds, for horses or traction engine and motor. All sizes of any size and shape. Address Electric Wheel Company, Walton Square, Quincy, Ill., U. S. A.

A FEW DOLLARS will start a prosperous mail order business. We furnish catalogues and everything necessary. By our easy method failure impossible. Write today. Milburn-Hicks Co., 718 Pontiac Building, Chicago.

AUTO CAR PRACTICE—"Homans' Self-Propelled Vehicles," 1907 edition just issued, right up to date, is the most complete book on the motor car practical, fully illustrated, 600 pages, handsomely bound. Price \$2.00 post paid, money back if not satisfied. Agents wanted. Specimen pages free upon request. For full particulars and information address Theo. Audel & Co., 65 Fifth Avenue, New York.

NEW PATENT STOCK AND DIE.—To let on royalty, new patent stock and die. Party with means. For full particulars and information address M. G. Cornell, 555 Coney Island Avenue, Brooklyn, N. Y.

INVENTORS seeking to put upon the market novelties, such as, cutting, toilet, etc., articles, send descriptive picture, drawing, etc., to Arthur Leicester, West New Brighton, New York.

WANTED, BOOKS.—The Scranton International Library of Technology, Vols. 1 to 81. Must be latest edition and in good condition. Address, stating lowest price for cash, The Librarian, State Agricultural College, Agricultural College P. O., Michigan.

AUTOMOBILE EXPERTS are in constant demand at high salaries. Our six weeks' course is the most thorough and practical, fitting men to drive, handle and repair. Day and evening classes. Special course for owners. New York School of Automobile Engineers, 146 West 56th Street, New York.

I AM LOOKING FOR A GOOD PATENT ARTICLE to push. Must have merit. Only full particulars noticed. Address W. B. Westerfield, 420 West 146th Street, New York City.

HELP WANTED.

WANTED.—High class specialty salesmen to represent large corporation in exclusive territory. For particulars address with references J. C. Punch, President, 901 Washington Avenue, St. Louis, Mo.

ENGINEER WANTED.—A college-bred engineer with practical experience and a capital of \$2000 to take active interest in and charge of an Engineering School to be affiliated with a well established School in the West. For full information and particulars, write to Dr. Dietrich, 730 Grand Ave., Milwaukee, Wis.

DRAUGHTSMAN.—Good positions for first-class architectural, mechanical and structural men in New York, Chicago and other cities. \$1,200 to \$2,500. Call or write us to-day. Hapgoods, 305 Broadway, New York.

MAN or Woman wanted by Mail Order Catalog House to travel, collect and appoint agents. No capital or experience required. \$21.00 a week. Expenses advanced. Secretary, Desk A-14, 381-385 Wabash Ave., Chicago.

PATENTS FOR SALE.

PATENT FOR SALE.—Hair waving and curling device, easy of manufacture and cheap. Can be used either hot or cold. Easily used by ladies from direction. For full particulars address Arnold, 60 W. 26th Street, N. Y.

PATENT FOR SALE.—I want to sell outright the proprietary rights in my new Improved Metal Fence Post, sure to be used in all parks, farms and gardens. C. C. Dolan, 324 Green Street, Lockport, N. Y.

PATENTS SOLD ON COMMISSION.—If you wish to buy or sell a patent write for particulars to E. L. Perkins, 72 Broad Street, Boston. Patent Sales Exclusively.

MACHINERY FOR SALE.

IF interested in power for any kind of light manufacturing, electric lighting, marine or other purposes, get information on the most improved kerosene oil engine by sending for catalogue to Remington Oil Engine Co., 41 Park Row.

PARTNERS WANTED.

PARTNER WANTED.—Interest in old established Patent business for sale at \$5,000. Rare opportunity for young man with technical training to learn this profitable business. For further information address T. S. Crane, 76 Nassau Street, New York.

PATTERNS AND MODELS.

WE MAKE wood patterns, metal patterns and light machine work. Phone No. 1274 Franklin, General Pattern and Model Co., 78 Centre St., N. Y. City. Write or telephone and our representative will be pleased to call.

INVENTIONS DEVELOPED; MODELS OF ANY description; special machinery; drawings. For full information and particulars, address Experimental Works, 207 Centre Street, New York.

INVENTORS! I MAKE MODELS, Patterns, Dies. I simplify, improve, and perfect inventions, develop ideas and design special machinery. Price reasonable. Best advice on inventions free. Saliger, 140 W. 23rd St., New York.

GAS-LIGHTING APPLIANCES.

THE "PNEU-WAY" of lighting gas! Lights Welsbach's without electricity from button on wall! Easily installed, over lasting. Ask your gas company or write Pneumatic Gas Lighting Company, 150 Nassau St., N. Y. Valuable Christmas surprise.

PROFESSIONAL CARDS.

CHEMIST.—Prof. C. A. Jacobson, S. B. Graduate student of Johns Hopkins University, now analyst and instructor in chemistry at York, Pa., does high grade analytical work. Write for terms.

Pump, self-cleaning, E. J. Feeny.....	834,569
Rack, A. S. Noonan.....	834,486
Radiator, J. H. Davis.....	834,364
Rail bond, C. E. Sturdevant.....	834,689
Rail brace, C. Ropp.....	834,409
Rail joint, E. A. Gilchrist.....	834,292
Railway appliances, time releasing device for levers controlling, J. P. Coleman.....	834,264
Railway frog, E. B. Entwistle.....	834,278
Railway switch mechanism, F. L. Young.....	834,439
Railway switch opening and closing device, street, E. A. Peterson.....	834,403
Railway tie, D. J. Raddick, Jr.....	834,536
Railway tie and rail fastening, metallic, A. Warfield.....	834,348
Railway track structure, G. M. Ervin.....	834,280
Railway track structure pattern, G. M. Ervin.....	834,279
Railways, electrical contact for trolley systems of electric, W. T. Oviatt.....	834,636
Razor, safety, F. H. Arnold.....	834,353
Receptacle fastener, E. F. Hulbert.....	834,810
Reel clamp, L. L. Bartlett.....	834,554
Reel seat, L. L. Bartlett.....	834,555
Refining engine, E. C. Crocker.....	834,713
Resistance device, W. L. Waters.....	834,424
Rifles to reduced ranges, device for adapt- ing service, A. N. Tucker.....	834,341
Rock drill, T. E. Adams.....	834,441
Rock drilling machine or engine, Hellman & Bayles.....	834,522
Rocker or support, G. Lindenthal.....	834,820
Rod coupling, pull, J. C. Miller.....	834,836
Rotary carrier and elevator, I. J. Ball.....	834,244
Rotary engine, J. A. Carter.....	834,260
Rotary engine, P. J. D. Kops.....	834,478
Rotary engine, S. Lach.....	834,528
Rotary motor, S. M. Atkins.....	834,675
Rotary motor, H. G. Leopold.....	834,819
Rotary steam engine, C. A. Kaiser.....	834,737
Rubber from rubber waste, recovering, W. A. Koneman.....	834,623
Rubber hose, making, W. H. Adams.....	834,351
Rubber-like gum, B. F. Spencer.....	834,760
Safety lock, Lievens & Jahn.....	834,310
Sails, reefing, M. Tornow.....	834,692
Sand drier, G. L. Webb.....	834,781
Sap collector, V. P. McVoy.....	834,841
Sash fastener, J. S. Planders.....	834,716
Sash fitting, window, T. W. Messenger.....	834,677
Sash lock, J. C. Meyer.....	834,586
Sash lock, C. F. Mason.....	834,743
Saw handhold, adjustable, T. Keeper.....	834,622
Sawing machine, B. L. Bailey.....	834,251
Scale, pitless platform, Ellis & Vreeland.....	834,276
Scales, attachment for platform, J. L. Bryan.....	834,258
Scraper, Noble & Quayle.....	834,634
Screen. See Window screen.	
Sealing means, hermetic, D. Genese.....	834,719
Seams for sheet metal, forming, F. H. Grafton.....	834,467
Securing device, M. A. Rollman.....	834,849
Seeder, R. H. Mouser, Jr.....	834,482
Seeder, W. J. & G. B. Davis.....	834,458
Separator, Gans & Gorham.....	834,378
Sewing machine, W. Wilson.....	834,436
Sewing machine tension, W. Wilson.....	834,600
Shade fixture, window, D. Hoyt.....	834,577
Shade hanger, J. K. Putnam.....	834,752
Shade trimming device, F. E. Fishing.....	834,715
Shank stiffener, J. E. Bickford.....	834,506
Sharpening machine, beet slicing knife, A. Maguin.....	834,390
Sheet delivery apparatus, A. B. Dick.....	834,791
Shelf bracket, E. F. Rotscheck.....	834,411
Ships' hulls, apparatus for cleaning, McLel- lan & McKinnon.....	834,399
Shoe polishing machine, coin controlled, H. Smith.....	834,766
Show case, W. K. Williams.....	834,699
Shutters, reciprocating shaft for roller, J. G. & L. G. Wilson.....	834,433
Shuttle, automatically threading, W. F. Draper.....	834,607
Sifter, ash, J. H. Austin.....	834,604
Sign, W. Borgmann.....	834,447
Sign and operating means therefor, illumina- ted, G. H. Dunkle.....	834,792
Signal operators, safety device for, B. A. Ovenshire.....	834,845
Signaling system, F. B. Rae.....	834,404
Skate, roller, H. R. Jones.....	834,526
Skirt hanger, C. F. Blue.....	834,706
Skirt support, A. H. Hawk.....	834,800
Skirts and blouses, device for supporting or holding in position, R. B. Hope.....	834,728
Sleeper, metallic, W. Friberg.....	834,288
Small arms, safety appliance for, J. Tam- bour.....	834,772
Smelting, Adams & Powell.....	834,240
Smelting furnace, F. L. McGahan.....	834,747
Smoke consumer and fuel economizer, fire bridge, Johnson & Carlaw.....	834,734
Snow and ice, means for keeping switch and signal apparatus free from, F. G. Shav.....	834,327
Snow and ice, means for keeping switch and signal apparatus free from, F. L. Young.....	834,440
Soap holder, J. F. Randall.....	834,405
Soldering iron, self-heating, R. W. Marvell.....	834,313
Sound waves, diaphragm for transmitting, E. H. Mobley.....	834,629
Spinning machine, T. H. Fairchild.....	834,609
Spraying machine, E. E. Allen.....	834,701
Square, folding carpenter's, J. Fregellas.....	834,773
Square, try collar & Benchene.....	834,872
Stacker, hay, J. C. Harris.....	834,724
Stalk cutter, Wendelin & Demmer.....	834,426
Stamp mill, P. Kirkegaard.....	834,385
Stamping and labeling machine, W. H. McCann.....	834,631
Steam, apparatus for reducing temperature of superheated, M. W. Sewall.....	834,589
Stove, J. M. Utz.....	834,345
Stove and furnace, F. Fieberger.....	834,282
Stuffing box, R. Titus.....	834,337
Subway or tunnel construction, R. W. Raftis.....	834,322
Swing, A. Hartzler.....	834,670
Switch operator, N. T. Gould.....	834,466
Switch throwing device, T. A. Gerlach.....	834,379
Switching and signal appliance, electric fluid pressure, W. J. Bell.....	834,704
Tag for live stock, H. A. Moyer.....	834,587
Tag stringing machine, I. Robbins.....	834,756
Take up, automatic, J. P. Hass.....	834,472
Talking machine, J. C. English.....	834,511
Telegraph cut out, F. A. Clogston.....	834,659
Telegraph instruments, sound magnifier for, F. O. Hanson.....	834,520
Telephone service, system and apparatus for measuring, H. D. Stroud.....	834,538
Telephone sets, protective apparatus for railway, C. E. Scribner.....	834,764
Telephone signaling apparatus, Butler & Lane.....	834,869
Telephone system, W. W. Dean.....	834,272
Telephone systems, means for charging storage batteries of, T. G. Martin.....	834,832
Test and wire connector, W. A. Fricke.....	834,669
Ticket, transportation, J. S. Young.....	834,859
Time recorder, workman's, E. E. Peterson.....	834,487
Tire rim, vehicle, A. L. Banker.....	834,504
Tires, etc., mold for rubber, W. Dunbar.....	834,608
Tongue switch, G. M. Ervin.....	834,281
Tongue switch, R. P. Williams.....	834,432
Tongue switch, F. Nather.....	834,484
Tool, combination, A. S. Augst.....	834,442
Tools, work holder for machine, C. C. M. Mortensen.....	834,481
Toy packing and supporting device, C. W. Beiser.....	834,452
Track cleaner, C. A. Madison.....	834,529
Traction device, T. W. Lingard.....	834,740
Traction engine and elevating grader, com- bined, H. A. Clapp.....	834,455
Transmitting apparatus, H. Shoemaker.....	834,497
Transom lifter, Rosenheim & Mombel.....	834,410
Trap, W. R. Fine.....	834,465
Trap, J. P. Sandefur.....	834,495
Trap, O. S. Underwood.....	834,539
Trellis, W. S. Hood.....	834,672
Trolley track switch, R. W. McIlvaine.....	834,483
Trolley wheel, H. L. Humphrey.....	834,302
Truck and other vehicle brake, railway, J. Gouldie.....	834,796
Truck, car, G. Lindenthal.....	834,821
Truss, F. Grater.....	834,712
Tuning hammer, A. L. Hale.....	834,463

The Franklin takes nothing for granted, but proves its way from start to finish.

Four years ago, the Franklin came out with its four-cylinders, air-cooled motor, and light-weight non-jarring construction; and backed up its principle with commonsense logic and a car that did things. But full proof was lacking.

Now we have the proof—facts that anybody can see—such proof of ability, endurance, and reliability as places the Franklin in a class by itself.

By winning the great Two-Gallon Efficiency Contest, the Franklin proved its unequalled efficiency and economy.

Whitman's marvelous record-breaking run from San Francisco to New York over the heaviest mountain grades, across the hot sandy trackless desert, through Nebraska mud—in 15 days, 2 hours, 12 minutes—proved an ability, reliability, and endurance not hitherto believed possible in any motor-car.

No other car in the world could have done these things. No other car has such qualities or such proofs.

Don't you want to read the story of Whitman's transcontinental dash, and his recent capture of the Chicago to New York record with the same car? Write us for them, and for the catalogue of 1907 Franklin cars.

- Shaft-drive Runabout \$1800
- 4-cylinder Touring-car \$2800
- 4-cylinder Light Touring-car \$1850
- 6-cylinder Touring-car \$4000

Prices in standard colors and equipment f. o. b. Syracuse. Special upholstery, equipment and color extra.

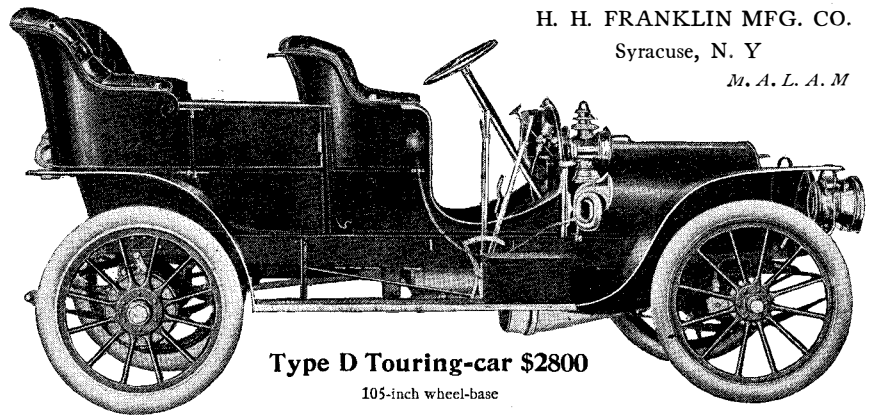

Type D Touring-car \$2800

105-inch wheel-base

H. H. FRANKLIN MFG. CO.

Syracuse, N. Y.

M. A. L. A. M.

Just Published

The New Agriculture

By T. BYARD COLLINS

12mo, 374 pages, 106 illustrations, cloth, price \$2.00

THIS new and authoritative work deals with the subject in a scientific way and from a new viewpoint. Dr. Collins has devoted his lifetime to the study of changing economic agricultural conditions. "Back to the soil" was never a more attractive proposition and never so worthy of being heeded as during these opening years of the twentieth century. Farm life to-day offers more inducements than at any previous period in the world's history, and it is calling millions from the desk. The reason for this is not at first obvious, and for this reason Dr. Collins has prepared the present work, which demonstrates conclusively the debt which agriculture owes to modern science and the painstaking government and State officials. Much of the drudgery of the old farm life has been done away with by the use of improved methods, improved stock and varieties. All this tends to create wealth by increased value of the product and decreased cost of production. Irrigation, the new fertilization, the new transportation, the new creations, the new machinery, all come in for a share of attention. The illustrations are of special value, and are unique. All who are in any way interested in agriculture should obtain a copy of this most timely addition to the literature of agriculture. A full table of contents, as well as sample illustrations, will be sent on application.

MUNN & CO., Publishers of "Scientific American," 361 Broadway, New York

Valuable Books Home Mechanics for Amateurs

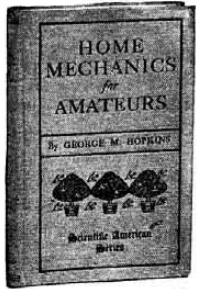

This book has achieved an unparalleled success in one week, and a Special Edition of 4,000 copies has been ordered. It is by far the largest and best book on the subject ever offered at such a low price.

370 Pages 326 Engravings Price \$1.50

TWENTY-THIRD EDITION EXPERIMENTAL SCIENCE.

By GEORGE N. HOPKINS Revised and Greatly Enlarged. 2 Octavo Volumes. 1,100 Pages. 900 Illustrations. Cloth Bound, Postpaid, \$5.00. Half Morocco, Postpaid, \$7.00.

EXPERIMENTAL SCIENCE is so well known to many of our readers that it is hardly necessary now to give a description of this work.

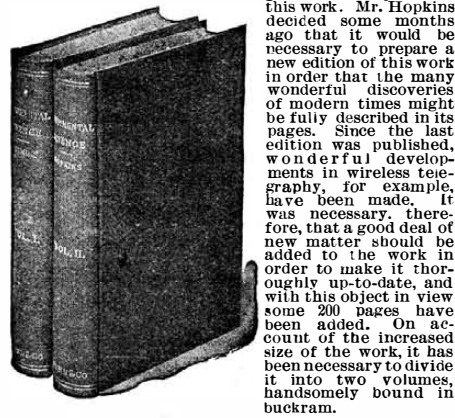

REVISED and ENLARGED EDITION The Scientific American

Cyclopedia of Receipts, Notes and Queries.

15,000 Receipts. 734 Pages. Price, \$5.00 in Cloth. \$6.00 in Sheep. \$6.50 in Half Morocco. Post Free.

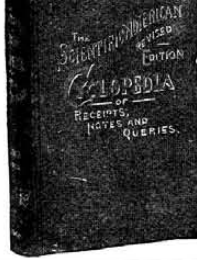

This work has been revised and enlarged.

900 New Formulas.

The work is so arranged as to be of use not only to the specialist, but to the general reader. It should have a place in every home and workshop.

Those who already have the Cyclopedia may obtain the

1901 APPENDIX. Price, bound in cloth, \$1.00 postpaid.

MAGIC Stage Illusions and Scientific Diversions, including Trick Photography



The work appeals to old and young alike, and it is one of the most attractive holiday books of the year. The illusions are illustrated by the highest class of engravings, and the exposes of the tricks are, in many cases, furnished by the prestidigitators themselves.

By A. A. HOPKINS. 568 pages. 420 illus. Price \$2.50.

JUST PUBLISHED Scientific American Reference Book

12mo. 516 Pages. Illustrated. 6 Colored Plates. Price \$1.50, postpaid

The result of the queries of three generations of readers and correspondents is crystallized in this book, which has been in course of preparation for months. It is indispensable to every family and business man. It deals with matters of interest to everybody. The book contains 50,000 facts and is much more complete and more exhaustive than anything of the kind which has ever been attempted. The "Scientific American Reference Book" has been compiled after gauging the known wants of thousands. It has been revised by eminent statisticians. Information has been drawn from over one ton of Government reports alone. It is a book of everyday reference—more useful than an encyclopedia, because you will find what you want in an instant in a more condensed form. Sixty years of experience alone have made it possible for the publishers of the SCIENTIFIC AMERICAN to present to the purchasers of this book a remarkable aggregation of information.

MUNN & CO., Publishers, 361 Broadway, NEW YORK

Table listing various mechanical parts and their prices, including Tunnel shield, Turbine, Type distributing machine, Valve, etc.

DESIGNS.

Table listing designs such as Badge, Casket name and handle plate, Game board, etc.

TRADE MARKS.

Table listing trade marks for various products like Ale, Batteries, Beer, Canned goods, etc.

LEARN WATCH REPAIRING

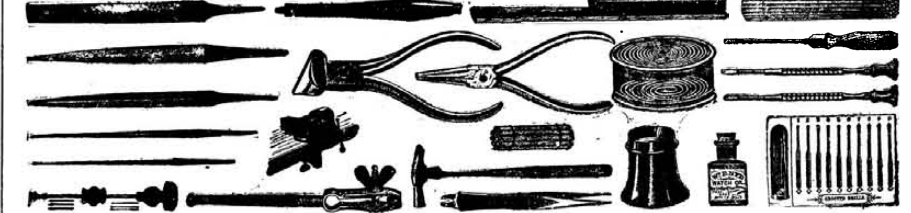

It's a trade easily learned; we will show you how absolutely Free of Charge. Our complete illustrated instruction book enables you to do the work at home giving you every advantage of the apprentice.

ROGERS, THURMAN & CO., Jeweler's Wholesale Supply House, 34 to 44 Michigan Ave., Chicago, Ill., U. S. A.

USE THE EDISON CELL THE YEAR AROUND

to spark your gas or gasoline engine. Mr. C. H. Jones, Inlet, Hamilton County, New York, writes that four cells ran his boat every day for two seasons without renewal.



EDISON Manufacturing Company

5 Lakeside Ave., Orange, N. J. 31 Union Square, New York 304 Wabash Ave., Chicago 25 Clerkenwell Road, London, E.C.

2 PASSENGER RUNABOUT

The car of smallest cost and greatest accomplishment. Holds world's record for efficiency, economy and endurance.

ORIENT FRICITION DRIVE BUCKBOARDS DELIVERY CAR

It does the work of three teams. A motor car of proven efficiency for Parcel and Express Delivery.



HOW TO MAKE AN ELECTRICAL Furnace for Amateur's Use.—The utilization of 10 volt electric circuits for small furnace work.



Krementz & Co., 77 Chestnut St., Newark, N.J.

A MONEY MAKER Hollow Concrete Building Blocks

Best, Fastest, Simplest, Cheapest Machine. Fully guaranteed.

THE PETTYJOHN CO. 615 N. 6th Street, Terre Haute, Ind.

WE SAVE YOU 35% TO 60% ON TYPEWRITERS

All Standard Makes Guaranteed equal to new in appearance and quality of work.

Clearing Sale Slightly Typewriters Used

We own and offer as wonderful bargains, 1,500 typewriters which have been used just enough to put them in perfect adjustment.

Send me 50 cents for sample of WILLIAMS' VENTILATING WINDOW-SASH FASTENERS



and you'll order a dozen more from your Hardware Dealer instantly.

Easily attached to sash without marring, bolt B operates between metal plates A and C in 6 to 7 space. Opens window for perfect ventilation at either top or bottom, or both, to extent of 5 inches.

CHAS. HOYT WILLIAMS 1061 Fidelity Building, BUFFALO, N. Y.

SPRINGFIELD ABRASIVE POLISHING WHEELS AND BLOCKS

Used for polishing machinery, cutlery and edge tools of all kinds and for removing rust spots from highly polished metal.

The Springfield Tire and Rubber Co., SPRINGFIELD, OHIO, U. S. A.

This Book is Free

It Tells You About a System of Handling Figures with Lightning Rapidity.

One Thousand Copies Will be Given Away to Those Who Apply First.

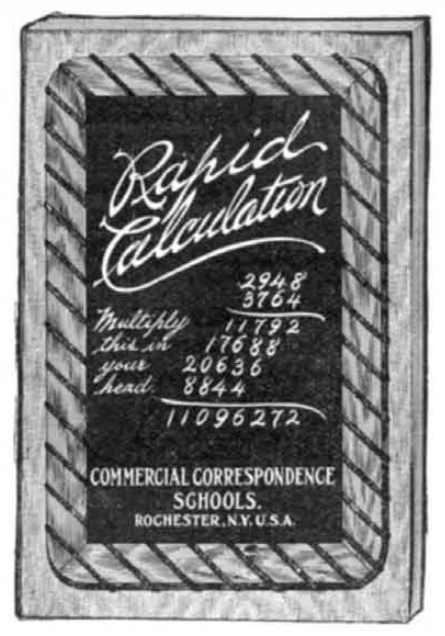

THIS BOOK tells about marvelous methods of shortening calculations; methods that simplify the most difficult business problems and sometimes make it possible to do the work of an hour in the space of a minute.

Prosperity Simplified!

Wherever you live, a small investment for an Ideal Concrete Machine will bring you a profitable, permanent business in the manufacture of Concrete Building Blocks. Previous experience unnecessary. Read what one machine did in thirty days.

Taylorville, Ill., 4, 30, 06. IDEAL CONCRETE MACHINERY CO., South Bend, Ind.

Sirs: We have had our Ideal Machine going every day for a month now with perfect satisfaction. Are getting all the business we can handle. All the blocks we can make for a month are already sold in advance. Must soon have another machine. Please send out of Concrete Block to use in getting out a letter head.

Respectfully,
E. W. COLEGROVE,
Mgr. Litholite Stone Co.

IDEAL Concrete Machines

turn sand, gravel, water and a little cement into building material more durable and ornamental than brick, stone or lumber, and far less expensive. The machine is simple, rapid, and everlasting. Has no cogs, chains, wheels, or gears. The same machine makes blocks in countless ornamental designs and natural stone effect.

Write and learn how easily one man with one Ideal Concrete Machine can start a profitable business wherever people live in houses.

IDEAL CONCRETE MACHINE CO.,
DEPT. E,
SOUTH BEND, IND.



Best 200 Recipes FREE!

The Enterprising Housekeeper. A famous book of tested, economical recipes and illustrated kitchen helps, published to sell at 25c. We will send it free. Just send your name and address.

The Enterprise Mfg. Co. of Pa., 2211 N. 34 St., Philada., U. S. A. Makers of the famous Enterprise Meat and Food Choppers.

Two Autos One Price

The Duryea Folding Rear Phaeton is a high powered runabout shown here or a comfortable light touring car. Why buy two when one will do? Investigate the scientifically and practically correct DURYEYEA. A postal card will bring leaflets.

DURYEYEA POWER CO., Aeyrud St., Reading, Pa.

Convert Your Bicycle Into a Motorcycle

at small cost by attaching the self-starting ERIE H. P. Power Outfit. This includes all parts by which anyone can easily make a powerful, durable motorcycle. weight 48 lbs. Bolts to frame. Speed 2 to 30 miles an hour. A hill climber.

Hundreds in use. Send stamp for outfit catalogue.

MOTORCYCLE EQUIPMENT CO., Hammondsport, N. Y.

60 YEARS' EXPERIENCE PATENTS

TRADE MARKS DESIGNS COPYRIGHTS & C.

Anyone sending a sketch and description may quickly ascertain our opinion free whether an invention is probably patentable. Communications strictly confidential. HANDBOOK on Patents sent free. Oldest agency for securing patents. Patents taken through Munn & Co. receive special price, without charge, in the Scientific American.

A handsomely illustrated weekly. Largest circulation of any scientific journal. Terms, \$3 a year; four months, \$1. Sold by all newsdealers.

MUNN & Co. 361 Broadway, New York
Branch Office, 625 F St., Washington, D. C.

Oranges, lemons, and grape fruit, Fernando Fruit Growers Association	57,037
Paints, liquid and paste, Lowe Brothers Co.	56,989
Papers, writing and drawing, R. J. Balston	57,015
Perfumes, liquid and powder, Colgate & Co.	57,022
Periodical, Shoe and Leather Reporter	57,054
Periodical, monthly, Twentieth Century Publishing Co.	57,067
Periodical, monthly, Vickery & Hill Publishing Co.	57,009
Periodical, weekly, McGraw Publishing Co.	57,072
Pianos, D. T. Peck	57,063
Pianos, J. H. Kelly	57,018
Pianos and self-playing pianos and parts thereof, Lyon & Healy	57,027
Plaster for molding, Patterson Coal & Supply Co.	57,078
Plaster for walls, Patterson Coal & Supply Co.	56,968
Plows and cultivators, Vulcan Plov Co.	56,969
Poplin piece goods, Relling, David & Schoen	57,084
Porter, Du Bois Brewing Co.	56,970
Porter, J. Labatt	57,019
Powder, tooth, R. Hudnut's Pharmacy	57,040
Prints, calico, Passaic Print Works	56,966
Publications, magazine or periodical, Buyers' Index Publishing Co.	56,967
Pumps, air, Wheeler Condenser & Engineering Co.	57,053
Radiators, steam and hot water, United States Radiator Co.	56,981
Razors and razor blades, Vom Cleff & Co.	57,011
Refrigerators, Eureka Refrigerator Co.	57,013
Relishes, certain named, M. A. Gedney Pickling Co.	57,074
Remedy for certain named diseases, Moyer Bros.	57,000
Remedy for certain named diseases, T. H. Le Dane	57,002
Remedy for diseases of the skin and scalp, E. W. Rose	57,041
Rice, Wall Rice Milling Co.	57,085
Roofing, ready tar and felt, Barrett Manufacturing Co.	57,066
Rubber erasers, E. G. Soltman	56,950
Search lights and parts thereof, electric, Korting & Mathieson Aktiengesellschaft	57,069
Sewing machines and attachments thereof, Simmons Hardware Co.	57,059
Shaft couplings, C. W. Levalley	56,972
Shirts and sheetings, cambrics, and long cloth, G. Willis & Co.	56,964
Shoes, leather, Ainsworth Shoe Co.	56,957
Silk piece goods, John Y. Farwell Co.	57,073
Soap, laundry, William Walke & Co.	56,926
Soap, soft, J. T. Kenney & Co.	56,982
Specific for all forms of female weakness and diseases, Elzena Co.	57,025
Specific for certain named diseases, Hentz Co.	57,021
Sporting goods, certain named, Wright & Ditson	56,996
Stockings, Glidden, Hyde & Co.	57,086
Talking machine records, Victor Talking Machine Co.	56,983
Tea and coffee, Meawarata Tea Co.	57,082
Tires, leather, Salisbury Tire Co.	56,996
Tobacco products, certain named, C. C. Rahn	57,030
Tobacco, smoking and chewing, Penn Tobacco Co.	56,991
Tonic and remedy for certain named diseases, Quinine-Whiskey Co.	57,080
Tonic, malt, Independent Brewing Ass'n.	57,062
Type casting and composing machines, Lanston Monotype Machine Co.	57,076
Whisky, H. Ehrmann & Co.	56,963
Whisky, E. Block & Sons	56,997
Whisky, Schuer Co.	57,017
Whisky, B. Winter	57,046
Whisky, Loeb, Bloom & Co.	57,051
Whisky, Strauss, Pritz & Co.	57,061
Whisky, Mono Vineyard & Wine Co.	57,070

LABELS

"Balm of Almond" for a toilet preparation, Charles Chemical Co.	13,145
"Cascara Pepsin," for chewing gum, C. P. Chemical Co.	13,170
"Fayette County," for canned corn, Fayette Canning Co.	13,165
"Fayette County," for canned tomatoes, Fayette Canning Co.	13,168
"George Washington," for canned corn, Fayette Canning Co.	13,167
"Hunter," for canned corn, Fayette Canning Co.	13,166
"Martha Washington," for canned tomatoes, Fayette Canning Co.	13,169
"Munyon's Paw Paw," for beverages, Munyon Company	13,146
"Narco Beef Iron & Wine," for a medicinal remedy, Hance Bros. & White	13,163
"Narco Bronchial Lozenges," for a medicinal remedy, Hance Bros. & White	13,162
"Narco Charcoal Tablets," for a medicinal remedy, Hance Bros. & White	13,161
"Narco Cold Tablets," for a medicinal remedy, Hance Bros. & White	13,160
"Narco Cough Remedy," for a medicinal remedy, Hance Bros. & White	13,151
"Narco Diarrhoea Remedy," for a medicinal remedy, Hance Bros. & White	13,159
"Narco Dyspepsia Remedy," for a medicinal remedy, Hance Bros. & White	13,158
"Narco Effervescent Phosphate of Soda," for a medicinal remedy, Hance Bros. & White	13,155
"Narco Fig Laxative Syrup," for a medicinal remedy, Hance Bros. & White	13,150
"Narco Headache Remedy," for a medicinal remedy, Hance Bros. & White	13,157
"Narco Liver Pills," for a medicinal remedy, Hance Bros. & White	13,156
"Narco Magnetic Liniment," for a medicinal remedy, Hance Bros. & White	13,152
"Narco Seidlitz Powders," for a medicinal remedy, Hance Bros. & White	13,153
"Narco Syrup of Hypophosphites," for a medicinal remedy, Hance Bros. & White	13,154
"Narco Wine of Cod Liver Oil," for a medicinal remedy, Hance Bros. & White	13,149
"Old Colony," for sheets, Edw. Malley Co.	13,174
"Polly-Shine," for a polishing powder and fluid for metals, New Orleans Soda Water Co.	13,172
"Prairie Vine," for medicine, L. A. Vincent	13,148
"Shogo Lithia," for a lithia spring water, Shogo Lithia Spring Co.	13,147
"Sunrise," for canned corn, Fayette Canning Co.	13,164
"The Kismet Multi-Do," for multifunction paper cutters, glass and bottle holders, and forceps, Kismet Co.	13,173
"Velvet Lustre," for shoe polish, M. F. Peterson & Co.	13,171

PRINTS.

"McArthur's Fire Escape and Jacob's Ladder," for fire escape and Jacob's ladder, M. J. McArthur	1,826
"Motorcycle Back, Bicycle Playing Cards," for playing cards, United States Playing Card Co.	1,825
"Star-Plaid Back, Bicycle Playing Cards," for playing cards, United States Playing Card Co.	1,824
"The Kismet Company," for multifunction paper cutters, glass and bottle holders, and forceps, Kismet Co.	1,823

A printed copy of the specification and drawing of any patent in the foregoing list, or any patent in print issued since 1862, will be furnished from this office for 10 cents, provided the name and number of the patent desired and the date be given. Address Munn & Co., 361 Broadway, New York.

Canadian patents may now be obtained by the inventors for any of the inventions named in the foregoing list. For terms and further particulars address Munn & Co., 361 Broadway, New York.

Saves 20% to 50% on Power

In nearly every plant one-half the total power goes to waste - it is eaten up in friction. A series of tests made by Prof. C. H. Benjamin, of the Case Scientific School, of Cleveland, Ohio, at sixteen different works, proved that it took over 50 per cent. of the total power of the plant to drive the shafting alone, when run in babbitted bearings. That meant 50 per cent. of the power was unproductive. It showed for the

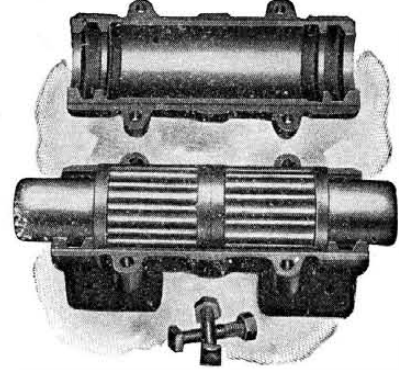

Peninsular Self-Oiling Roller Bearings

an average saving in friction over the babbitted bearing as follows: 43.2 per cent. for the 1 1/2 inch shaft; 73.6 per cent. for the 2 7/8 inch shaft; and 76.6 per cent. for the 2 1/2 inch shaft.

OUR GUARANTEE:

Without knowing anything whatever about your plant, we guarantee, if you are now using babbitted bearings, to save 10 per cent. of your total power by replacing them with Peninsular Self-Oiling Roller Bearings.

10 per cent. is assured; 50 per cent. has been achieved, and never have we fallen below a saving of 20 per cent.

For any reliable firm we will gladly put the claim to the test by equipping a shaft, or, if desired, their entire plant with Peninsular Self-Oiling Roller Bearings and allow them to be run for 30 to 60 days on trial. If they fail to substantiate our claim, the bearings can be returned at our expense.

Peninsular Self-Oiling Roller Bearings, besides what they save in power, save enormously in belting and general wear and tear. Running in a bath of oil, they are non-heating and not a drop of oil is lost—a saving in oil of 50 per cent. over a babbitted bearing. These bearings are adapted to works of any character.

Write for Our Book on "POWER-SAVING"

giving official tests comparing relative efficiency of the babbitted bearings with the Peninsular Self-Oiling Roller Bearings in reducing friction; also containing letters from companies engaged in all branches of manufacture now using Peninsular Self-Oiling Roller Bearings.

Unless we save 10 per cent. of your total power they can be returned at our expense.

GEORGE A. McKEEL & CO., Ltd., Transmission Dept., JACKSON, MICH.

LET US BE YOUR FACTORY
WRITE FOR ESTIMATE ON ANY ARTICLE YOU WANT MANUFACTURED
STAMPINGS, MODELS, EXPER. WORK
WRITE FOR FREE BOOKLET
THE GLOBE MACHINE & STAMPING CO.
970 Hamilton St., Cleveland, O.

Bad Water
DON'T DRINK—
Our Filters Purify, Deodorize, Decolorize. Booklet Free.
Buhring Water Purifying Co.
68 Murray St., New York

"KNIFE" BALL BEARINGS
For thrust or weight or both. No fitting, just push them on. All sizes 1-4 in. Shaft and up. 10 cts. in stamps for samples.
PRESSED STEEL MFG. CO., 545 The Bourse, Phila., Pa.

AUTOMOBILE INSURANCE
Every owner of an Auto should insure his car against loss or damage, whether in actual riding or in transit. We fully insure you against such loss or damage, however sustained. Premiums low. Full est reliability.
H. W. BEALS, 76 William Street, New York

ICE MACHINES
Corliss Engines, Brewers and Bottling Machinery. THE VILTEL MFG. CO., 899 Clinton St., Milwaukee, Wis.

MODELS & EXPERIMENTAL WORK.
Inventions developed. Special Machinery
E. V. BAILLARD, 24 Frankfort Street, New York.

RUBBER
Expert Manufacturers
Fine Jobbing Work
PARKER, STEARNS & CO., 228-229 South Street, New York

Model and Experimental Work. Years of experience. M. P. Schell, 1759 Union St., San Francisco

MODELS & GEARS
INVENTIONS PERFECTED UNION MODEL WORKS
193 SO. CLARK ST. CHICAGO, ILL.

LINENOID—A MOLDED MATERIAL MADE OF PURE LINEN
CRANE BROS. MANUFACTURERS, WESTFIELD, MASS.

BE A WATCHMAKER
Send for our free book, How to be a Watchmaker. Stone School of Watchmaking, 904 Globe Bldg., St. Paul, Minn.

MODELS & CHICAGO MODEL WORKS
ESTABLISHED 1867 179 E. MADISON ST. CHICAGO, ILL.
WRITE FOR CATALOGUE OF MODEL SUPPLIES

FREE ILLUSTRATED BOOK
We will on request send to you postpaid, this book, also our special plans by which you can secure any article in our catalog absolutely free. Write to-day—don't miss this chance. J. Andrae & Sons Co., 114 W. Water Street, Milwaukee, Wis.

ELECTRONS AND THE ELECTRONIC
Theory are discussed by S. R. OLIVER LODGE in SCIENTIFIC AMERICAN SUPPLEMENTS 1428, 1429, 1430, 1431, 1432, 1433, 1434. Price 10 cents each, by mail. Munn & Company, 361 Broadway, New York City, and all newsdealers.

BUSINESS OPPORTUNITY—Men of Business
Interested in a new field for making money, will find in our proposition what they are seeking. We have a New Plan in the Mail Order Line that will please those seeking a good investment with large profits. A Fortune for the right person.
THE F. H. ALDEN CO., E. 4th St., Cincinnati, O.

STAMPS 100 all different, Venezuela, Uruguay, Paraguay, Peru, Japan, Mexico, Cuba, Philippines, etc., and Album, 1000 10c FINELY MIXED 20c 1000 hinges 5c. Agents wanted, 50 per cent. New List Free.
C. A. Stegman, 5946 Cote Brillante Ave., St. Louis, Mo.



FREE!
This Valuable Text Book
Contains formulas, facts and tables, very helpful in solving problems incident to friction transmission.
This company makes more and better
PAPER & IRON FRICTIONS AND PAPER PULLEYS
than any other concern. Let us show you how they will save you money by saving power and preventing trouble.
The Treatise on Friction Transmission will be sent gladly to anyone who has use for it. A postal, stating occupation and firm with which you are connected will bring it to you free.

The Rockwood Mfg. Co.
1904 English Ave.
Indianapolis, Ind., U. S. A.

FACTORY MEN We can help you to better earnings and
better results by our course of instruction in Cost Accounting. Small cost—spare hours—easy payments. Let us tell you our plan. It costs nothing to investigate. Our students to-day hold the best places and manage the best factories. A postal will bring you the details.
INTERNATIONAL ACCOUNTANTS' SOCIETY, Inc.
59 Fort St. W., Detroit, Mich.

BRAIN WORKERS—THINKERS!
Have you that clearness of mind so essential to success in your undertakings? You can have, but not until your physical system is right. I want to tell every interested reader of SCIENTIFIC AMERICAN how he may attain perfect physical health by adopting the simplest, most rational and logical method yet known—RAW FOOD DIET—not a fad of "cranks," not a theory, but an infallible method of proper eating. Send \$1.00 for sack of my MACERATED WHEAT (30 days supply), and convincing letters, or merely write for literature and information blank.
BYRON TYLER, 334 Life Bldg., Kansas City, Mo.

YOUR PATENT
Carefully Developed May Be a Success!
Development of ideas, experiments, models. Specialty, small machinery and fine instruments. Modern equipments. Technical office. RICHTER BROS. Mech. Electrical Engineers and Manufacturers, 115 Court Street, Hoboken, N. J. Two minutes from D. L. & W. Depot.

I Print My Own Cards
Circulars, books, newspaper. Card Press \$5.00. Larger \$15.00. Money saver maker. All easy, printed rules. Write factory for catalog, presses, type, paper, cards.
The Press Co., Meriden, Conn.

New Catalogue of Scientific and Technical Books

A new 112-page Catalogue is now ready for distribution. It is entirely new and lists 5,000 of the latest and best books of a scientific and technical nature. Copies are being mailed to all subscribers to our periodicals, but those who purchase our publications at news stands, or read them in libraries, should send at once for a copy of our Catalogue, which will be mailed free to any address in the world.

MUNN & COMPANY, Publishers, 361 Broadway, New York City

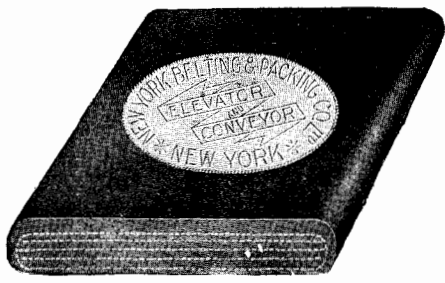

Rubber Elevator & Conveyor Belting

FOR CONVEYING AND LIFTING
BROKEN STONES, COAL, COKE, WOOD
PULP, GRAVEL, SAND, SUGAR, etc., etc.

**SPECIAL CONSTRUCTION
EXCEPTIONAL QUALITY**

**NEW YORK BELTING &
PACKING CO., Ltd.**

91-93 CHAMBERS STREET, NEW YORK

**SEND \$1.00 NOW
FOR OUR NEW BOOK
How To Make Alcohol**

and De-Nature it, from Farm Products, for use in Farm
Engines, Automobiles, Heating and Lighting. Com-
plete instructions, skills illustrated. New Free Alco-
hol Law and Government Regulations.

SPON & CHAMBERLAIN

123 S. A. Liberty Street - NEW YORK

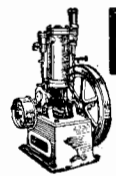

CHARTER

Stationaries, Portables, Hoisters, Pump-
ers, Sawing and Boat Outfits, Combined
with Dynamoes.

Gasoline, Gas, Kerosene.

Send for Catalogue.

State Power Needs.

CHARTER GAS ENGINE CO., Box 148, STERLING, ILL.

Scales All varieties at lowest prices. Best Railroad
Track and Wagon or Stock Scales made.
Also 1000 useful articles, including Saws,
Sewing Machines, Bicycles, Tools, etc. Save
Money. Lists Free CHICAGO SCALE CO., Chicago, Ill.

**THE FAMOUS
TURCO-AMERICAN
GLASS PIPE**

is the ideal combination of the Oriental
Narghile without its claustrophobia, and the
Occidental pipe without its injurious
effects on the health of the smoker.
The Turkish Water Pipe affords
the healthiest smoke as proved
by the proverbial longevity of
the Turks. The famous Turco-
American Glass Pipe is a por-
table pipe with all the health
comforts of the Narghile
and the ease of use
of the every day
pipe.

Through
its clear
non-break-
able glass bowl
you can see
every wreath of
smoke, in itself
the greatest delight
to the tasteful pipe
smoker. The nicotine
is segregated absolutely
in the bottom of the bowl.
Thus the Turco-American
Pipe assures a delightfully
dry, clear, clean smoke. No
biting the tongue, no wet to-
bacco remnants to throw away as
every bit of tobacco in the pipe
is consumed to a clear white ash.
Smoke it a week, and you will be so
attached to it that you would not part
with it for many times the amount of its cost. But if not entirely
satisfactory in every respect, return it and we will send back your
money. Straight or drop stems. Price \$1.50, postpaid in United
States and Canada. Foreign countries add postage. Reference:
National Bank of Commerce. Booklet for the asking.

The Turco-American Pipe Co., 214 South Ave., Rochester, N.Y.

Bausch & Lomb Reading Glasses



The lenses of these large magnifying glasses are carefully
ground and polished and are mounted in durable nickle rim
with ebonized handle. Every SCIENTIFIC AMERICAN reader
ought to have one of these glasses. There are hundreds of things
in every day work that are easier to see with a little magnification.

PRICES: 2 inch lens, \$0.75, Post Paid. Catalog on request.
3 inch lens, 1.20, Post Paid.

Bausch & Lomb Opt. Co., Rochester, N. Y.
NEW YORK BOSTON WASHINGTON
CHICAGO SAN FRANCISCO

TOOL KNOWLEDGE CHEAP



In fact you can have it free!
This cut represents our new Tool
Catalogue No. 22. It is cloth-
bound and contains 950 pages all
about Tools. Full descriptions
and thousands of illustrations.
Sent post-paid on receipt of \$1.00
which is refunded on your first
purchase from us of \$10.00 or over

MONTGOMERY & CO.
105 Fulton St., N. Y. City

DURABILITY CLEANLINESS

ESTIMATED VALUE

All the good points of all other flooring materials
—from wood to marble—with many advan-
tages found in none of these—and not one of
their disadvantages—make up the great su-
periority of

**Pennsylvania
Rubber Tiling**

AS AGAINST WOOD FLOORINGS (hard
or soft) *Pennsylvania Rubber Tiling* is prac-
tically unaffected by the hardest wear, abso-
lutely non-porous and water-proof, and there-
fore non-absorbent of unsanitary elements,
which fairly teem in wood after short use (a
particularly important point in public buildings,
hotels and hospitals). At the same time the
physical advantages of wood—warmth and
resiliency under foot—are far superior in
Pennsylvania Rubber Tiling.

AS AGAINST MARBLE and tilings of
cemental or ceramic character: All these are
slippery and unpleasant to the tread and give
forth nerve-grating sounds—are with greatest
difficulty kept spotless—and unavoidable crevices
form unsightly features. These draw-
backs are wholly lacking in *Pennsylvania
Rubber Tiling*, which is practically silent to
the tread, never slippery, seal-close at the
joints, and fully as durable as any of the above.

SPECIAL DESIGNS APPROPRIATE TO ANY INDIVIDUAL INTERIOR ARE
READILY EXECUTED WITHOUT EXTRA COST.

Pennsylvania Rubber Company
JEANNETTE, PA.

NEW YORK
1665 Broadway
CHICAGO
1241 Michigan Ave.
PHILADELPHIA
615 North Broad St.



ATLANTA, GA.
102 Prior St.
BOSTON, 167 Oliver St.
BUFFALO, N. Y.
Main and Tupper Sts.
LONDON, 4 Snow Hill

ELEGANCE

SAFETY

LEARN TO BE A WATCHMAKER

Bradley Polytechnic Institute
Horological Department
Peoria, Illinois
Formerly Parsons Horological Inst.
Largest and Best Watch School
in America

We teach Watch Work, Jewelry,
Engraving, Clock Work, Optics,
Tuition reasonable. Board and
rooms near school at moderate rates.
Send for Catalog of Information.

THE MIETZ & WEISS
Send for Catalogue

OIL ENGINES
Stationary 1 1/2 to 80 H. P.
Marine 3/4 to 100 H. P.

Use KEROSENE and FUEL
OILS. Direct connected Gen-
erators, Pumps, Air Compressors,
Hoists, etc. Thousands in use in
all parts of the world.

AUGUST MIETZ
198-198 Mott St., New York, U.S.A.

Write to-day

MOTSINGER AUTO-SPARKER
starts and runs
Gas Engines without Batteries.

No other machine can do it successfully
for lack of original patents owned by us.
No twist motion in our drive. No belt
or switch necessary. No batteries
whatever, for make and break or
jump-spark. Water and dust-proof.
Fully guaranteed.

MOTSINGER DEVICE MFG. CO.
14 Main Street, Pendleton, Ind., U. S. A.

THE "LEADER."
1 1/2 H. P. Gasoline Auto-Marine Engine

Built like a watch. Beautifully Finished. Accu-
rately Constructed. Light, Strong, Reliable, and
Noiseless in operation. Suitable for launches
from 15 to 19 feet in length. Price complete,
\$75 net, no discount. Thoroughly guaranteed.
Perfect Speed Control. Complete descriptive Cata-
logue upon application. Manufactured by

CLAUDE SINTZ,
292 S. Front St., Grand Rapids, Mich.

\$15 "GEM" Adding Machine

Free 10-Day Trial. We Pay Ex-
pressage. Has a Resetting Device
Mechanical Production. Does the work of high-priced machines.
Handiest thing an engineer can own. Great for outdoor work.
Carried in your pocket. Guaranteed for two years. *Catalog Free.*

Automatic Adding Machine Co., 475 Broome St., N. Y. City

**A HARVEST OF
GOOD POINTS.**

**PAUL E. WIRT
FOUNTAIN PEN**

Combines all the good points of other
fountain pens with a number exclusively its own.
Does not leak, flows freely, writes smoothly.
The original fountain pen. The leader in merit
for 25 years.

Always Ready—Always Writes

Made in 100 styles to suit all—Sold by leading
dealers everywhere. Send for illustrated catalogue to

Box G-23, Bloomsburg, Pa.

STEAM USERS

Rainbow Packing

The original and only genuine
red sheet packing.

The only effective and most
economical flange packing in ex-
istence.

Can't blow Rainbow out.

For steam, air, hot or cold
water, acid and ammonia joints.

Beware of imitations.

Look for the trade mark—the
word Rainbow in a diamond in
black, three rows of which extend
the full length of each roll.

Manufactured exclusively by
PEERLESS RUBBER MFG. CO.
16 Warren St., New York

COLD GALVANIZING
AMERICAN PROCESS. NO ROYALTIES.
SAMPLES AND INFORMATION ON APPLICATION.

Established
1820.

**NICKEL
AND
Electro-Plating**
Apparatus and Material.
THE
Hanson & Van Winkle
Co.,
Newark, N. J.
28 & 30 S. Canal St.
Chicago.

10 Days Trial

of any Lewis violin, guitar, mandolin, banjo,
or other stringed instrument, flute or clarinet,
now sold direct. Lewis Instruments have been
made for a generation in our workshops in
Chicago, U. S. A., Eisleben and Schillbach
(Germany) and Pedrona (Italy). You risk
nothing in ordering and you can now save
50% and more—all teachers' and dealers'
dis-counts. You know that Lewis instruments
have long been regarded as the standard. Do not miss
this ten days' trial offer. Write for free catalog No. 15.
Wm. G. Lewis & Son (Est. 1869) 220 Wabash Av. Chicago

BANDMEN!—Clarinet and Flutes at Wholesale Prices!

THE LOCKE ADDER
Only \$50

The Modern
Business Necessity

CAPACITY 999,999,999

The famous Calculating Machine. Enthusiastically endorsed the world over. Rapid, accu-
rate, simple, durable. Two models: oxidized copper finish, \$50; oxidized silver finish, with
case, \$100.00, prepaid in U. S. Write for Free Booklet and Special Offer. Agents wanted.

C. E. LOCKE MFG CO., 25 Walnut St., Kensett, Iowa

Another Good Thing from
the Goodell-Pratt Shops.

RECIPROCATING AUTOMATIC DRILL

Useful for drilling holes where Braces, Breast Drills
or Hand Drills are inconvenient. Maximized Power and
Minimized Friction. *Catalogue tells all—free.*

GOODELL-PRATT COMPANY. Greenfield, Mass.

Vose

Have Been Established
55 Years

and are receiving more
favorable comments to-
day from an artistic
standpoint than all
other makes combined.

**We Challenge
Comparisons.**

By our easy payment plan every family
in moderate circumstances can own a
Vose piano. We allow a liberal price
for old instruments in exchange, and
deliver the piano in your house free of
expense. You can deal with us at a
distant point the same as in Boston.

Catalogue, books, etc.,
giving full information
mailed free.

VOSE & SONS PIANO CO.
160 Boylston St.,
Boston, Mass.

PIANOS

HEIMET OIL LUBRICATES ANYTHING
IF YOU HAVE A HOT BOX TRY IT. CH-BESLEY & CO
15 to 21 South Clinton Street.