

SCIENTIFIC AMERICAN

[Entered at the Post Office of New York, N. Y., as Second Class Matter. Copyright, 1904, by Munn & Co.]

Vol. XCI.—No. 14.
ESTABLISHED 1845.

NEW YORK, OCTOBER 1, 1904.

[8 CENTS A COPY
\$3.00 A YEAR.]

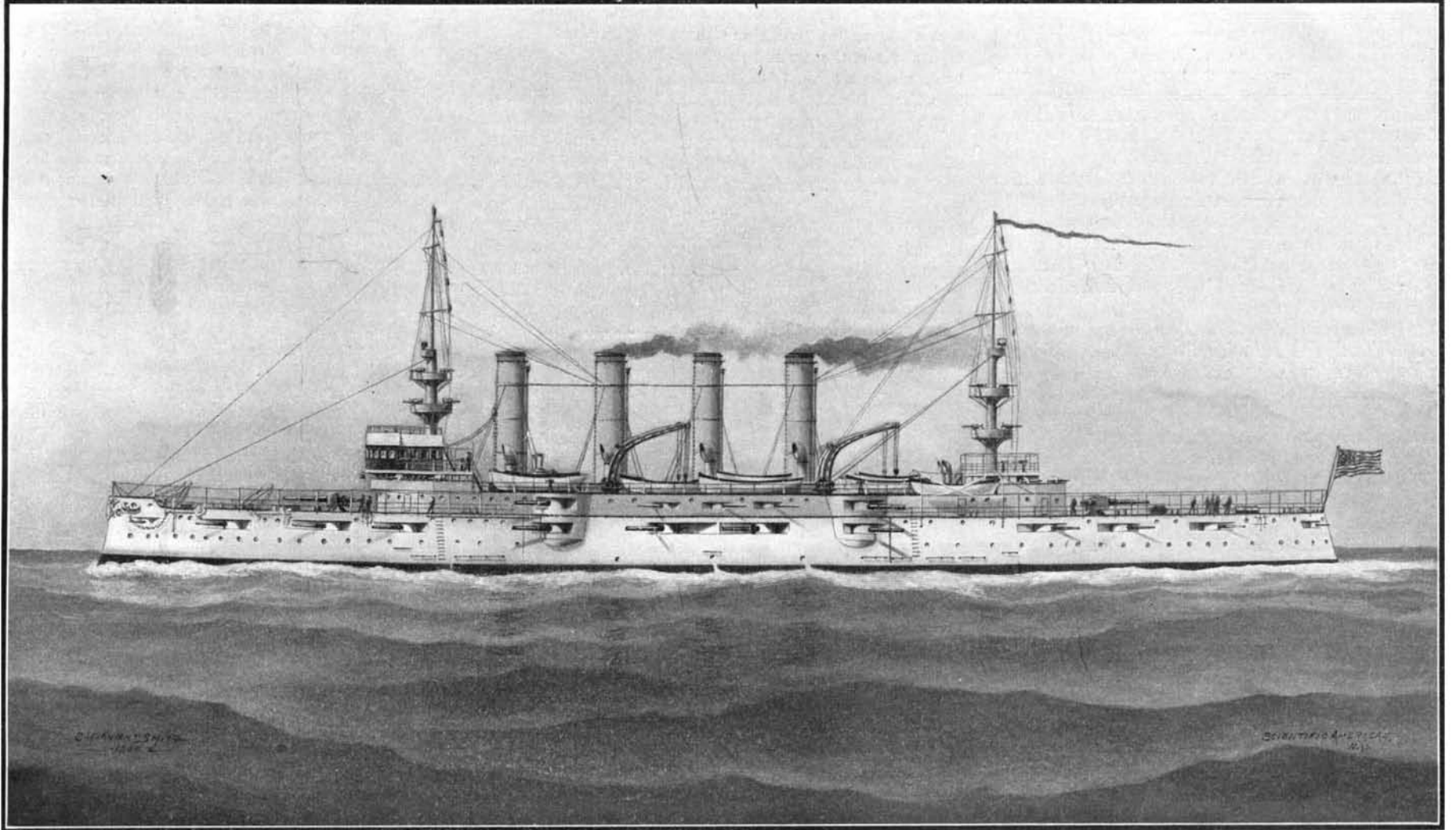

Displacement, 9,700 tons. Speed, 22 knots. Bunker Capacity, 1,500 tons. Armor: Belt, 4 inches; topsides, 4 inches; deck, flat, 2 inches; slopes, 3 inches. **Armament:** Fourteen 6-inch R. F.; eighteen 3-inch R. F.; twelve 3-pounder semi-automatic; four 1-pounder automatic; two 3-inch field guns; two 0.30-caliber machine guns; eight 0.30-caliber automatics. **Complement, 645.**

PROTECTED CRUISER "MILWAUKEE," LAUNCHED SEPTEMBER 10, AT UNION IRON WORKS, SAN FRANCISCO.

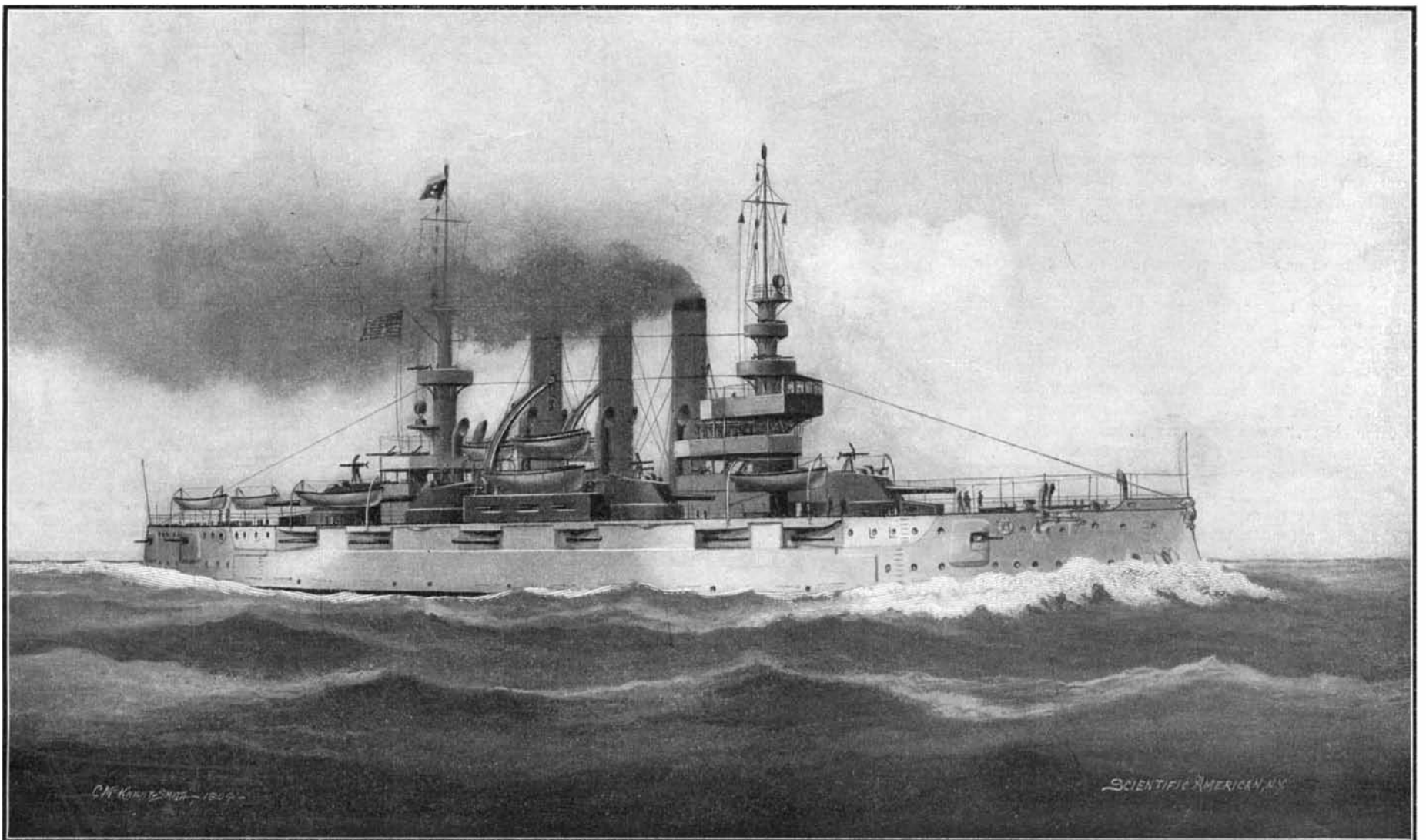

Displacement, 16,000 tons. Speed, 18 knots. Coal Supply, 2,200 tons. Armor: Belt, 11 inches to 4 inches; casemates, 7 inches; main turrets, 12 inches; secondary turrets, 8 inches; deck, 3 inches. **Armament:** Four 12-inch, eight 8-inch, twelve 7-inch, twelve 3-inch rapid-fire guns, 26 smaller guns. **Torpedo Tubes, 4 submerged. Complement, 803.**

BATTLESHIP "CONNECTICUT," LAUNCHED SEPTEMBER 29, AT THE BROOKLYN NAVY YARD.--[See page 231.]

SCIENTIFIC AMERICAN

ESTABLISHED 1845

MUNN & CO., - - Editors and Proprietors

Published Weekly at
No. 361 Broadway, New York

TERMS TO SUBSCRIBERS

One copy, one year for the United States, Canada, or Mexico \$3.00
 One copy, one year, to any foreign country, postage prepaid, 20 lbs. 5d. 4.00

THE SCIENTIFIC AMERICAN PUBLICATIONS.

Scientific American (Established 1845).....\$3.00 a year
 Scientific American Supplement (Established 1876)..... 3.00 "
 Scientific American Building Monthly (Established 1885)..... 2.50 "
 Scientific American Export Edition (Established 1878)..... 3.00 "
 The combined subscription rates and rates to foreign countries will be furnished upon application.
 Remit by postal or express money order, or by bank draft or check.
 MUNN & CO., 361 Broadway, New York.

NEW YORK, SATURDAY, OCTOBER 1, 1904.

The Editor is always glad to receive for examination illustrated articles on subjects of timely interest. If the photographs are sharp, the articles short, and the facts authentic, the contributions will receive special attention. Accepted articles will be paid for at regular space rates.

WARSHIP CONSTRUCTION IN GOVERNMENT YARDS.

The fact that the first large battleship to be constructed in a government yard has been built in the same time as that required to construct a sister ship in what is probably the best equipped private yard in the United States, is a matter that is giving the Navy Department no little satisfaction; for it has disposed effectually of the popular belief that warship construction in a government yard was necessarily tedious, costly, and poorly done.

How it has come about that such an impression exists is a question that takes us back to the day of the building of the "Maine" and the "Texas." Both of these vessels were long in construction, the cost of which was very high; but this is explained by the fact that when they were built, our navy yards were suffering from very serious political interference, and were burdened with a large number of employees who had gained their entrance to the yards through political influence, and regarded their positions as of that kind in which a minimum amount of work is to be done for a maximum amount of pay. To turn out efficient work under such circumstances, especially in the difficult art of warship construction, was a simple impossibility—as the various naval constructors soon found out to their sorrow. Moreover, when the "Maine" and the "Texas" were built, steel warship construction was in its infancy in this country, and the navy yards were but poorly equipped for the task, much of the plant being quite out of date.

To-day, however, we have changed all that. Thanks largely to the energy and courage of the late Chief Naval Constructor, our navy yards have been entirely emancipated from political control, new drydocks, buildings, and plants have been built and installed, until to-day our best yards, and notably that at Brooklyn, are in first-class condition, and capable of turning out the very best work.

The Bureau of Construction and Repair, as soon as it felt that it was in condition to handle warship construction to advantage, began to urge strongly upon the Secretary of the Navy the advantage of constructing some of our new ships in government yards. The principal arguments in favor of such a course were, first, that the private builders, who were showing a great lack of diligence in the prosecution of their contracts for new ships, would be stimulated to greater activity if they knew that ships were being built in government yards, and a new standard of expeditious work thereby set up. Another, and not less important object aimed at, was to insure that the full working staff of the navy yard would be constantly employed at all seasons of the year. Hitherto the navy yards had labored under the great disadvantage that when the regular repair work was completed, it became necessary to discharge a large proportion of the working force. The mechanics thus set free scattered in search of work, and in the following season, when repair work became active, it was necessary to gather a new force, which had to become acquainted with the plant and the general working of the navy yard before the best results could be secured. Now, it was judged that by having one or more new ships always on the stocks, the necessity for discharging any of the force, when repair work slackened, would be removed, inasmuch as it could be transferred to new construction.

It is now nearly two years since the new regulations were put in force, and it was decided to put them to a searching test by ordering the construction at the Brooklyn navy yard of one of the largest battleships ever built for any navy. At the same time, the contract for a sister ship was placed at the private yard of the Newport News Shipbuilding Company, one of the most completely equipped plants in the world.

The results have exceeded the most sanguine expectations of the Navy Department, for, in spite of the disadvantages under which the Brooklyn navy yard labored, owing to the fact that it had to build entirely new ways and erect a large cantilever traveling crane before the keel of the vessel could be laid, the

"Connecticut" has been built in about the same time, namely, eighteen months, as was the "Louisiana," while both the time of construction and the cost of the vessel have been considerably less than was estimated at the time the order for the vessel was given—and this in spite of the fact that the hours of labor are shorter, and the pay is higher in government than it is in private shipyards.

The SCIENTIFIC AMERICAN has always been a strong advocate of the policy of building some of our new warships at government yards, and therefore it gives us particular pleasure to congratulate the naval constructors on the excellent results that have been achieved in the case of the "Connecticut." The effect of the new policy on the private shipbuilding firms of the country has been everything that could be desired. There has been a notable acceleration in the rate of construction, the "Louisiana" having been launched in eighteen months from the date of the laying of the keel, no less than 7,000 tons of steel being worked into her hull at that period. This is a great improvement on any previous work, the best record previous to this for a battleship being about two years' time, and this for a vessel of smaller size and less importance than the "Louisiana." It is to be hoped that the good results that have been attained will encourage Congress to allot a certain portion of every shipbuilding programme to government yards, and that not only New York, but League Island, Boston, and other leading government yards will be given their share of the work.

THE CHALLENGE CUP MOTOR-BOAT CONTEST.

The races for the Gold Challenge Cup of the American Power Boat Association, which are being run off as we go to press, have proved that the development of the motor boat in this country has progressed to a point at which it can compare in point of speed and reliability with the fastest of the European craft. In saying this it is but fair to state, however, that many of the boats are carrying engines of foreign make, and to this extent the performance is robbed of much of its purely American character. In the lines of the boats, and the design of their propellers, however, both elements of the highest importance as affecting the speed, even of these diminutive craft, the contestants are the product of our own builders.

In the first day's race, intended to be over a 32-knot course from the Columbia Boat Club House, West 85th Street, up the Hudson and back, but actually measuring 27.25 knots, the best performances were those of the winner, Mr. W. K. Vanderbilt's "Mercedes VI.," and the "Vingt-et-un," which made the highest speed over the course. The "Challenger," which has just returned from her unsuccessful quest of the Harmsworth Cup in England, was the scratch boat, and she allowed "Vingt-et-un" 10 minutes 17 seconds; "Speedway," 19 minutes 20 seconds; "Mercedes," U. S. A., 20 minutes 5 seconds; "Macaroni," 26 minutes 56 seconds; "Mercedes VI.," 31 minutes 12 seconds; "Shooting Star," 31 minutes 29 seconds; "Flip," 32 minutes 17 seconds; "Marcirene II.," 56 minutes 55 seconds; and "Josephine," 59 minutes 17 seconds. The first to cross the line was to be the winner. The "Mercedes VI.," steered by Mr. Vanderbilt, proved so speedy that she was the first to overtake the mark boat, which had to drop anchor at once, in order to furnish a turning point. The "Mercedes VI." finished first, covering the course at a speed of 23.07 miles an hour. The "Vingt-et-un," which finished fifth, made the best speed, averaging 24.76 miles an hour. The second race was run off in a nasty sea, and many of the smaller boats shipped so much water that they had to stop to bale out, the "Mercedes VI.," which was the first around the mark, being one of these. The "Vingt-et-un" came through in splendid style, thanks to her high freeboard, and careful handling, covering the course at an average speed of 25.36 statute miles per hour. This performance is particularly gratifying because of the fact that she carries an American-built engine. This speed brings the American record within less than a mile of the 26.25 miles an hour recently made at Monte Carlo by the "Trefle-a-Quatre." In both races the "Challenger," as the result of some defect in her thrust block, did not go over the course.

WATER VERSUS STEAM POWER.

Steam power is going out of fashion. Water power is coming in. Electrical transmission is working the change. Carried to its possible results, this utilization of water powers means the extinction of the steam engine. Such a complete victory for water power in many cases is by no means improbable. An example is ready at hand. In Niagara Falls, a city of large and varied manufacturing interests, not a single steam engine is at work. This instance is not as exceptional in its conditions as might be thought. Great as is the power of Niagara Falls, the cost of development per unit of plant capacity is quite as large as that on many another river. On the other hand, the price of steam

coal at Niagara Falls is much below that in New England and many other parts of the country.

Results in the extinction of steam power plants at Niagara Falls are exceptional in degree rather than in kind. In hundreds of villages and towns throughout the country steam engines have been almost, if not altogether, displaced by electrically-transmitted water power. In scores of cities steam engines of the largest sizes have been shut down, and their work taken up by electric power from distant waterfalls. The steam plants thus rendered silent and useless are not designed for any particular line of industry. Some stand in former power houses of electrical supply and railway systems, that are now operated from sub-stations with transmitted water power. Idle steam plants in such locations may be seen at Montreal and Albany, Buffalo and St. Paul, Salt Lake City and San Francisco. In some such cases, as at Buffalo and Montreal, the steam plants are not started even at times of maximum loads on the electric systems. Others of these idle steam plants are in large cotton mills, as at Montreal, where the electric motors that are doing the former work of the steam equipment have an aggregate of thousands of horse-power. Large machine works furnish other illustrations of steam plants that have been put out of service by transmitted water power and electric motors. In one such case, at Concord, N. H., the shops of the railway that hauls all of the coal entering the city are operated by electric motors of about 550 horse-power total rating, and the steam plant that formerly did the work is permanently out of use. Another case, this time in Buffalo, shows the substitution of electric water power for steam in a plant for the manufacture of pumps, where the horse-power required is over two thousand. So the list might be indefinitely extended to include grain elevators and malt houses, flour and cereal mills, rubber works and iron foundries, ore smelters and chemical works, and almost every sort of manufacturing industry that requires mechanical power in large or small units. No loads are too great to be operated by transmitted water power, and none are too small for efficient driving with electric motors. The sewing machine making shirts, and the heavy machinery employed in the construction of steel ships, are alike moved by the transmitted energy of distant, falling water.

With factory loads as well as electrical supply and railway systems shifting from steam to water power, the amount regularly transmitted to cities is already large and is rapidly increasing. Portland, Me., and Springfield, Mass., each receive more than two thousand horse-power electrically transmitted from waterfalls. At both Manchester, N. H., and Hartford, Conn., the corresponding figures are more than three thousand. About ten thousand horse-power goes alike to Schenectady, N. Y., and San Francisco, Cal. St. Paul, Minn., gets approximately four thousand horse-power, Albany, N. Y., fully as much, and Los Angeles, Cal., more. Montreal leads the list of centers for transmitted water power with nearly thirty thousand, and Buffalo is a close second with much more than twenty thousand horse-power, at times of maximum load. The city of Niagara Falls itself is so close to the electric generating stations that its supply of energy may be said to be distributed rather than transmitted, but the amount utilized there is nearly seventy thousand horse-power. To this striking example of great industries built up about an electrically-developed water power may be added that of Shawenegan Falls, Massena, and Sault Ste. Marie, near each of which thousands of electrical horse-power are distributed to manufacturing plants.

Without the aid of electrical transmission and distribution this displacement of steam by water power could never have taken place on its present great scale. Even at water-power cities the distribution and the application of energy to manufacturing plants is accomplished much more readily by electrical means than with the water itself. It is largely for this reason that many water powers previously unused are now becoming centers of industry. The great majority of manufacturers, however, cannot be drawn away from the centers of population, even by the advantages of cheap water power, and for them the choice is necessarily between steam plants and transmission from distant waterfalls. This choice is based on commercial rather than on sentimental or even sanitary reasons. Electrical energy transmitted from water powers displaces steam in manufacturing plants, not so much because the former is cleaner, safer, and more conducive to good health, as because it is cheaper. Perhaps the most remarkable feature of the electrical development of water power is the fact that the energy can be transmitted ten, scores, and even hundreds of miles, and then delivered in large units at prices below the cost of power from coal. Of course, the distances over which water power can be profitably transmitted vary much with the conditions at both the generating and the receiving ends of the line, but experience has amply shown that a transmission of some length may be made to advantage from almost every water power

of considerable size. As the cost of fuel goes up, the distance of profitable transmission for water power increases, but even very cheap fuel sometimes fails in competition with transmitted water power. Even free fuel could not hold its own against transmitted water power in all cases, because the labor cost of operation is much higher in a steam than in a water-power plant. For illustration of these facts, to some extent, it is only necessary to consider the case of Buffalo, where the price of steam coal sinks sometimes as low as \$1.50 per ton, and water power is delivered from a distance of 23 miles. As an example of the rates for transmitted energy from water falls that have enabled it to displace steam power, the flat charge of twenty-five dollars per horse-power year may be mentioned. This charge for power, 24 hours per day and 365 days in the year, is made to large consumers by several transmission systems, and is constant for the number of horse-power covered by the contract without regard to the time during each day that it is actually consumed. If the purchaser of electric power on this basis can use it only 10 hours per day and 300 days per year, or 3,000 hours, his rate per horse-power hour amounts to 0.83 cent for the energy actually consumed. Where the power can be used 24 hours per day and every day in the year, the flat rate of \$25 per horse-power year amounts to only 0.29 cent per horse-power hour. Who would shovel coal for this money?

THE HEAVENS IN OCTOBER.

BY HENRY NORRIS RUSSELL, PH.D.

We may begin our survey of the sky this month by going out about 9 o'clock on any clear evening in the middle of October, facing south, and looking up about two-thirds of the way from the horizon toward the zenith. The constellation directly before our eyes will then be Pegasus. Its characteristic feature is a large square of second magnitude stars, which has now nearly reached the meridian. A number of stars on the right also belong to the constellation.

Below this is the extensive but inconspicuous Aquarius, south of which, and in line with the western side of the great square of Pegasus, is a solitary bright star, Fomalhaut, in the otherwise unimportant constellation of the Southern Fish. Still farther south, and almost on the horizon, is Grus—the Crane—a constellation conspicuous in the southern skies, whose two brightest stars just rise above the horizon of New York.

West of Aquarius is Capricornus. The bright object in this constellation is the planet Saturn. It contains no very bright stars, the most conspicuous ones being a little pair to the right of Saturn, both of which appear double in a field-glass.

From the northeastern corner of the great square of Pegasus, a line of stars of about the second magnitude extends to the left, parallel to the Milky Way. The first two of these are in Andromeda, and are both of some interest. The second in order—Gamma Andromedæ—is a fine double star, whose green companion is again divided by powerful telescopes into a close pair in rapid orbital motion.

The first of the two—Beta Andromedæ—serves as a pointer to one of the most interesting objects in the heavens—the Great Nebula of Andromeda. This can be seen, even with the naked eye, as a faint patch of light on the line from Beta Andromedæ through the faint star to the northward, produced about as far again. With a field-glass it appears as a dull patch of light, very different in appearance from the neighboring stars. A larger instrument shows more detail, but it is left to photography to show that the visible part of the nebula is but a portion of a magnificent spiral system, covering an area of sky about as large as the full moon.

Photographs of this nebula have been so frequently published that they are probably familiar to most of our readers. No satisfactory explanation of the remarkable form of this nebula, and the many similar ones, has yet been suggested.

Farther to the left, beyond Andromeda, is Perseus—a group of fairly bright stars in the Milky Way—and lower still is Auriga, with the brilliant star Capella.

The planet Jupiter is by far the most conspicuous object in the southeastern sky. The small triangle of stars above it marks the head of Aries. The lower southeastern sky is occupied by Cetus—a very large but rather uninteresting constellation. A polygon of stars below Jupiter marks the monster's head, and its body extends a long way to the westward, including one conspicuous star, which stands very much alone about 30 deg. west of Fomalhaut.

Taurus is near the eastern horizon, with Aldebaran just risen, and the Pleiades higher up.

Following the Milky Way west from Perseus, we first reach the familiar zigzag of Cassiopeia, pass next through the scattered stars of Cepheus, and so reach Cygnus—a constellation full of interest. Its brightest star—Alpha Cygni—is remarkable for its enormous distance from us. The most careful measurements fail to show any sensible parallax, and we may con-

clude that the star is so remote that its light must take hundreds of years to reach us, and that it is probably thousands of times brighter than our sun.

A contrast to this enormous orb is afforded by the little star 61 Cygni, which may be found as follows: Alpha Cygni is at the head of a cross of stars lying in the Milky Way. If we complete the quadrilateral formed by the top and the eastern arm of the cross, we come upon a triangle of faint stars. The southernmost and faintest of these—just comfortably visible to the naked eye—is 61 Cygni.

This has long been known as a remarkable star, both because it is double, and especially on account of its very large proper motion, which would carry it over a distance equal to the moon's apparent diameter in about 350 years.

It was one of the first stars investigated for parallax, and the first for which a definite positive result was obtained. The value first found by Bessel for its distance has been but slightly altered by the results of later observers, and it appears that its distance is about 500,000 times that of the sun. At this distance the sun would appear about as bright as the pole-star does to us, so that it is evident that the two components of 61 Cygni are by no means as bright as the sun.

Below Cygnus, in the Milky Way, is Aquila, marked by the bright star Altair, with a fainter one on each side. North of this, and west of Cygnus, is the still brighter star Vega, in Lyra.

Hercules is below this in the northwest. Draco lies between Hercules and the pole, and Ursa Major is low on the northern horizon.

THE PLANETS.

Mercury is morning star in Virgo, and is at his greatest elongation on the 1st, when he is 18 deg. west of the sun. This distance is less than the average, because the planet is almost at the nearest point in his orbit to the sun. On this account he receives more than the average amount of light, which compensates for his closeness to the sun by making him appear brighter, so that he is as easy to see as usual.

During the first week of the month he rises at about 4:30 A. M. almost due east, and is well visible before the dawn interferes.

Later in the month he gets nearer the sun, and is not easy to see. On the 20th he is about 4 deg. north of the bright star Spica Virginis, but the conjunction will be hard to observe.

Venus is evening star in Libra and Scorpio. She is gradually getting farther from the sun, but is still south of him, and hence inconspicuous, because she sets so early—about 6:30 P. M. on the 15th. She is still 140,000,000 miles from us, and is only one-quarter as bright as at her best.

Mars is morning star in Leo. At the beginning of the month he is quite near Regulus, and moving slowly southeastward toward Beta Virginis. He rises at about 2:30 A. M. on the 15th, and within a few minutes of this time all through the month.

Jupiter is in Aries, and is in opposition on the 18th. He is visible all night long, and is the most conspicuous object in the sky.

Some unusually interesting configurations of his satellites occur during this month. On the 1st, the second and third satellites are eclipsed, while the first travels across the planet's disk. On the 3d, the first and second satellites and their shadows transit across the planet at the same time, affording a very interesting sight. With a telescope of fair size, it is possible to notice the differences in the size of the satellites and their shadows, and in their rate of motion.

The first satellite comes on later, but makes up about half its delay during the transit. The phenomena last from 7 to 11 P. M., and so are at a very convenient time for observation.

The same thing happens again on the evening of the 10th, beginning at 10 P. M. This time the second satellite comes on first, is overtaken by the first, and leaves the planet last. The two satellites are very close together all the time.

On the 12th, before 7:15 P. M., Jupiter has but one visible satellite, the first and third being in front of the planet, and the second behind it. The same phenomenon occurs about 9 P. M. on the 19th. There are other eclipses and transits of the satellites during the month, but they are less interesting.

Saturn is evening star in Capricornus, crossing the meridian at 8:30 on the 1st and 6:30 on the 31st.

Uranus is evening star in Sagittarius, setting at about 8:30 on the 15th.

Neptune is morning star in Gemini, and crosses the meridian at about 4:30 A. M. on the same date.

THE MOON.

Last quarter occurs at 9 A. M. on the 2d, new moon at midnight on the 8th, first quarter at 1 A. M. on the 16th, full moon at 6 A. M. on the 24th, and last quarter again at 6 P. M. on the 31st.

The moon is nearest the earth on the 8th, and farthest away on the 20th. She is in conjunction with Neptune on the 2d, Mars on the 6th, Mercury on the

7th, Venus on the 10th, Uranus on the 13th, Saturn on the 17th, Jupiter on the 23d, and Neptune again on the 29th. None of these conjunctions is close, but on the 27th there is an occultation of the first magnitude star Aldebaran. As seen from Washington, the star disappears at 7:28 A. M. and reappears at 8:26. It will be daylight at the time, but the occultation can be observed telescopically.

At Sea, September 14, 1904.

SCIENCE NOTES.

W. M. Watts has previously shown that there appear to be two distinct kinds of connection between the spectra of allied elements and their atomic weights. In the case of zinc, cadmium, and mercury, and of gallium and iridium, the differences between the oscillation frequencies of certain lines of the one element are to the differences between the oscillation frequencies of the other element as the squares of their atomic weights. In applying this method, some uncertainty exists as to the correspondence of the lines in the different spectra; but it is possible, by accumulating evidence of this kind, to obtain indications as to the probable atomic weight of radium from a comparison of its spectrum with those of mercury, barium, and calcium. By selecting appropriate lines, it is possible to deduce for the atomic weight of radium the values 226.32, 226.42, 225.21, 225.32, 226.52, from the first type of relationship, and the values 225.05, 223.47, 220.36, 223.13, 227.39, and 224.63 from the second type of relationship. The mean of all these results is 224.89, the experimental value being 225. While the spectroscopic evidence now adduced is not of a very certain character, it serves to throw doubt upon the calculations by which Runge and Precht deduced the value 258 for the atomic weight of radium, and indicates that the analytical value is not incapable of being reconciled with the spectroscopic evidence.

In a paper recently presented to the Académie des Sciences, Dr. Charles Repin brings out a new method of acting directly upon the blood and freeing it from toxic substances which it may have absorbed. By a special apparatus which he uses, he literally washes the blood by drawing off the serum and replacing it by an artificial serum formed of a saline solution. In this way the corpuscles are furnished with a fresh liquid and the serum containing the poisonous substances is eliminated from the body. To carry this out, the blood, which is taken by aspiration from a punctured vein, is at once mixed with eight or ten times its volume of a saline solution. The mixture is sent into a centrifugal separator which is so arranged that all the blood corpuscles are collected at one point. They are taken from the separator by a pump which re-injects them into the system at once. The apparatus is entirely automatic and works continuously. It extracts the plasma with all the toxic products and replaces it by an artificial serum. No harm is done to the corpuscles, which do not suffer from their short passage to the outside. M. Repin's method has been applied at the Pasteur Institute. The apparatus is operated by a horizontal shaft which revolves at a high speed. The shaft carries four arms projecting at right angles and each arm has a conical chamber mounted on the end. The shaft and chambers are traversed by a system of tubes which allow three functions to be carried out: First, the blood mixture is brought into the chamber; second, the globules are separated and provided with the right amount of liquid for re-constituting the original volume; third, the surplus of the diluting liquid is drawn off. The apparatus contains a number of details which are necessary to prevent coagulation of the blood and make it work successfully. These will no doubt be illustrated in a succeeding description. By simply passing the blood through the apparatus, all the operations are carried out automatically and the re-constituted blood is returned to the system, after having been washed entirely free from the toxic matter it may have absorbed. Dr. Repin is now demonstrating the physiological effects of this method.

Dr. P. L. Sclater writes an account in Knowledge of the cape jumping hare, an animal so rarely seen in London that the animal from which the artist, Mr. Goodchild, has drawn the illustration is the only one which has ever been brought alive to England. The spring-haas, or cape jumping hare, is nocturnal, or, at any rate, crepuscular, in its habits. It lives in small communities on the open veldt, both in the plains and in the mountain ranges, and makes large and deep burrows in the ground, whence it emerges toward sunset, being rarely seen in the bright daylight. When chased in the open it proceeds in great bounds like a jerboa or kangaroo, for which its highly developed hind legs are admirably adapted, and is even said to move faster up hill than down. Its food is entirely of a vegetable nature, and consists of roots and green stuff of all sorts. Its flesh, according to Lé Vaillant, is very good to eat, and in his day was much appreciated by the Hottentots and Kaffirs.

A NOVEL AUTOMATIC PUMP FOR INFLATING AUTOMOBILE TIRES.

BY THE ENGLISH CORRESPONDENT OF THE SCIENTIFIC AMERICAN.

Every automobilist is painfully aware of the arduousness, time, and manual labor involved in the inflation of pneumatic tires. With a view to overcoming this exhausting, and, to say the least, primitive system

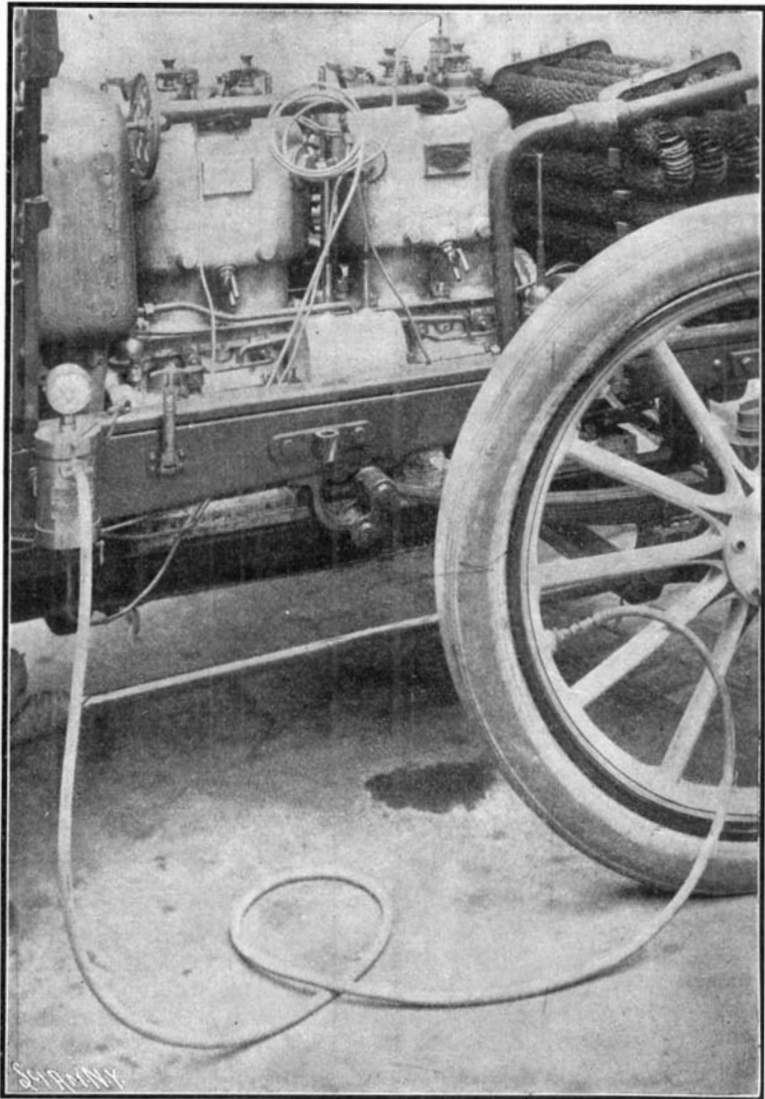

AUTOMATIC AUTOMOBILE TIRE INFLATER.

for the inflation of tires, a novel and convenient apparatus, called the "Pompeesi," has been placed on the market by Messrs. Jarrott & Letts, Ltd., of London, who handle the American Oldsmobile runabout in Great Britain.

In this device manual labor is entirely dispensed with, for the process is accomplished entirely by the engine. Inflation is achieved by utilizing the force generated by the explosion of the gaseous vapor in the cylinder of the motor, in a simple and efficient manner. Furthermore, owing to the ingenious system adopted, it can be utilized with an engine comprising any number of cylinders, the work being as efficient with one cylinder as a multiple-cylinder engine. As will be recognized from the accompanying illustration, the device is small and compact, and constitutes a permanent fixture of the vehicle, being attached to the frame, dashboard, or any other convenient spot.

The apparatus consists primarily of a special plug-fitting. One of the ignition plugs is unscrewed and withdrawn from its place in the cylinder wall, and this special fitting is inserted. This special fitting, although it allows the ignition plug perfect and free communication with the combustion chamber, at the same time does not permit of its being screwed close against the cylinder wall. The fitting is a small metal box provided with a valve, which admits the consumed gaseous vapor from the cylinder after the explosion.

From this valve box extends a length of coiled steel tubing to the main part of the apparatus. A long section of pipe is provided, so that the hot gases may be sufficiently cooled before they enter the cham-

ber of the apparatus. This cylindrical chamber, which is made of nickel, is for the purpose of purifying the exploded gases. Within are placed a series of circular baffle plates with a narrow opening at one point of their peripheries, to admit of the gases traveling from one concentric passage to the other. The gas enters the purifying box in the center, and is forced around the circular baffle plates into the outside passage. This chamber serves a useful object in arresting all oil or other impurities that may be admitted from the combustion chamber of the motor, and which would prove deleterious to the fabric of the tire.

To the upper part of the cylindrical box is attached the flexible rubber hose leading to the valve of the tire.

Owing to the fact that no interference is afforded to the combustion of the gases in the explosion chamber by the insertion of the ignition plug into the special fitting or valve box, this section of the apparatus can always be left in connection. When the operation of tire inflation is not in progress, the flexible India-rubber hose is disconnected from the cylindrical purifying chamber, and a cap screwed on to render it a perfectly tight joint.

To operate the apparatus, the engine is first stopped. The valve of the deflated tire is then connected to the fixed cylindrical purifying box by the flexible rubber tubing. The motor is started again. The greater part of the exploded gases in the cylinder to which the special plug is screwed pass through the inlet valve of the valve box at the plug. The valve then closes, and as the gases cannot escape back again, they pass through the coiled steel hose, cooling in transit, pass through the purifying chamber, and thence pass into the tire. When the desired pressure in the tire is attained, as indicated by the gage attached to the purifying chamber, the engine is stopped, and the flexible rubber tubing is disconnected.

When the engine is running, the exploded gases still escape for a time into the valve box; but as their passage is stopped when they reach the purifying chamber, the pressure behind the valve in the valve box soon becomes sufficient to prevent the valve opening and the gases escaping in that direction, and they therefore pass into the muffler or exhaust box in the usual manner. At the bottom of the purifying chamber is a small drain cock, through which any oil that may have collected in the purifying chamber may be withdrawn.

The "Pompeesi" has proved highly efficient in actual operation. It can be connected and set to work in ten seconds. The saving of time occupied in the inflation

of the tires, too, is considerably reduced, varying from two to three minutes according to the size of the tire. Experience has shown that the consumed gases of the explosive mixture exercise no deleterious effect upon the fabric of the tires. In fact, the reverse has proved to be the case, as they act more as a preservative. The tires furthermore stand inflated appreciably longer by this means, for the temperature of the gases is reduced to that of the outer atmosphere, which fact was proved in a special test, no fall in the pressure being observed on the gage after the tires had stood inflated for twenty-four hours. Owing to the simplicity of the device, there is nothing to get out of order. It can be as easily adapted to all engines, whether the plugs be fitted horizontally or vertically, or whether magneto ignition is employed. The device, which is of French

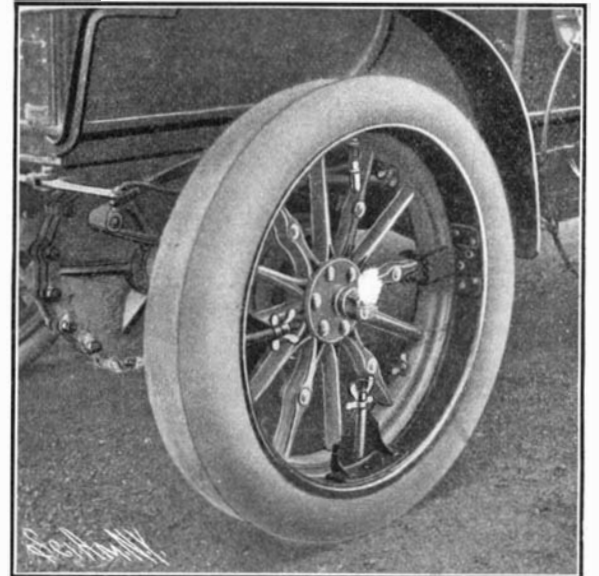

NOVEL SPARE WHEEL AND TIRE DEVICE FOR AUTOMOBILES.

origin, has been awarded the gold medal by the Automobile Club of France.

NOVEL SPARE WHEEL AND TIRE DEVICE FOR AUTOMOBILES.

An interesting reserve-tire device has been placed upon the English market. By this contrivance, instead of carrying a spare tire or tube ready for replacing a tire that fails through puncture or any other defect on the road, a complete rim and tire fully inflated ready for use is carried on the car. The device comprises a special rim carrying the tire, which is fully inflated. To this rim are fixed three clips. When a puncture occurs, instead of stripping the defective tire from the wheel, and substituting a new tire or repairing the defective one, this reserve wheel and tire is firmly clipped by thumb screws to the rim of the defective wheel. This wheel lifts the punctured tire off the ground and carries all the friction, so that the punctured tire is as safe as if it were withdrawn from the wheel.

The advantage of this invention is that delay on the road through a failing tire is reduced to the minimum.

The spare tire and wheel only occupies one minute to attach in position and even tire inflation is dispensed with, as the tire is carried already fully inflated. The accompanying illustration shows the principle of the invention, and how it is attached. When carried, a hoop or ring is made the same size as the tire in order to clip it thereto. This appliance is the invention of Messrs. Davies Brothers, of Llanelly, Wales.

A MACHINE FOR AUTOMATICALLY MAKING INCANDESCENT GAS MANTLES.

In this country, at the present time, about forty million incandescent gas mantles are used annually. Vast as this quantity is, the industry in America is still in its infancy; and widely as the mantle itself has been introduced, the average user knows little of the composition of the mantle.

Briefly stated, a mantle is made as follows: A "stocking" is first knitted of cotton thread and then saturated with a solution of thorium.

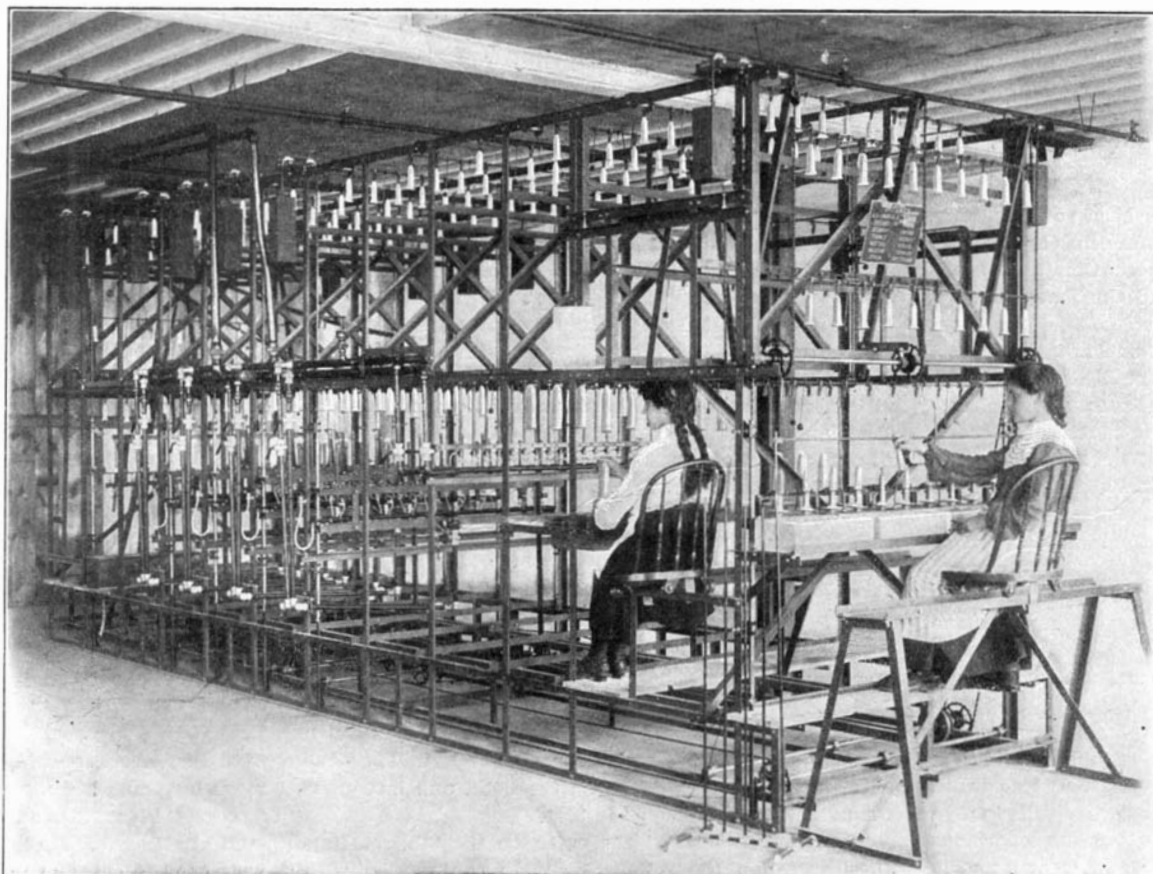

THE ROBIN AUTOMATIC INCANDESCENT MANTLE-MAKING MACHINE; CAPACITY, 4,500 MANTLES PER WORKING DAY OF TEN HOURS.

Thus impregnated, one of the stocking's ends is sewed up with asbestos thread, a loop being left by which the stocking is manipulated in the subsequent steps of the process. The sewed stocking is ignited at its top by a flame for the purpose of consuming the thread. After this treatment, all that is left is a reticulated structure consisting almost entirely of oxide of thorium. "Shaping and hardening" are the next stages through which the mantle must pass, both being effected by the Bunsen flame. Lastly, the mantle is dipped into a coating solution in order to protect it from breakage in transportation.

All these processes have hitherto been carried out by hand. The asbestos loop to which we have referred constitutes a means whereby a workman can pick up the mantle with a hooked rod and hold it over the Bunsen flame in shaping it. The percentage of losses incurred through imperfect shaping and breakage is high. The shaping and hardening of the mantle is accompanied by an unequal shrinkage which often renders the mantle unfit for use. Even if this did not occur, irregularities in the wall of the stocking may be formed, the result of imperfections in the thread, which cause unequal absorption of the impregnating thorium. In addition to these objections, expense naturally plays its part. The number of mantles which a single workman is able to burn off and shape in a day is necessarily limited. The number of imperfect mantles is large; consequently, the cost of the hand-made mantle is relatively high.

For the purpose of overcoming these objections, Mr. Joseph T. Robin, 258 Canal Street, New York city, has invented and patented what is probably the first machine for automatically making incandescent mantles. So successful has his apparatus been in actual operation, that it is fast taking the place of handwork in America and in Europe. A single machine is able to produce as many as four hundred and fifty perfect mantles per hour, and does the work of eight shapers, besides that of the dippers and others. Only two operators are required to serve the machine, one to place the stockings in position, the other to remove them after they are finished. An indicating device shows the exact number of mantles treated by means of the apparatus.

Naturally, the first improvement introduced by Mr. Robin in the process of making mantles was the prevention of irregularities caused by imperfections in the thread of the fabric. This difficulty Mr. Robin succeeds in overcoming by employing a metal ring, secured to the bottom of the stocking, which ring is of sufficient weight to lessen the contraction of the stocking during the operation of burning out. Furthermore, the ring prevents the formation of folds. In the accompanying diagram we illustrate a mantle, or rather an impregnated stocking, in which the full lines indicate the fabric before it is burnt off, and the dotted lines the form of the structure after the fabric has been destroyed. The ring clearly appears at the bottom of the mantle pictured in the diagram. Besides answering the purpose specified, the ring also serves to hold open the lower end of the stocking, so that the flames of the shaping and hardening burners can easily enter the interior, and to avoid the collapsing of the stocking during the dipping or coating process.

As shown in the accompanying photographic reproduction of an actual machine in operation, only two operators are needed. These operators are placed one in front and the other at one end of the machine. The operator seated within the machine has simply to hang the impregnated stockings by their asbestos loops upon the hooks of a series of carrier bars that intermittently move before her during the regular operation of the machine. Each carrier bar, by an ingenious arrangement of sprocket wheels and chains, is caused to move first over a set of burners by which the fabric of the stockings is burnt off; then to a set of burners by which the lower part of the mantle is shaped;

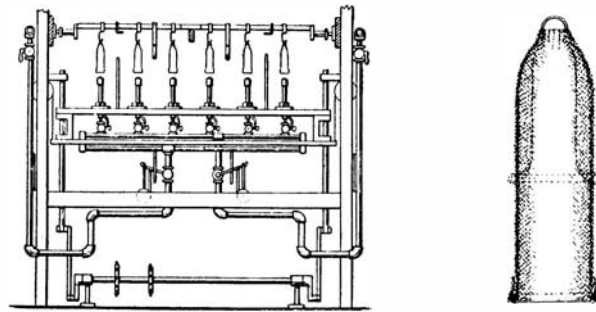
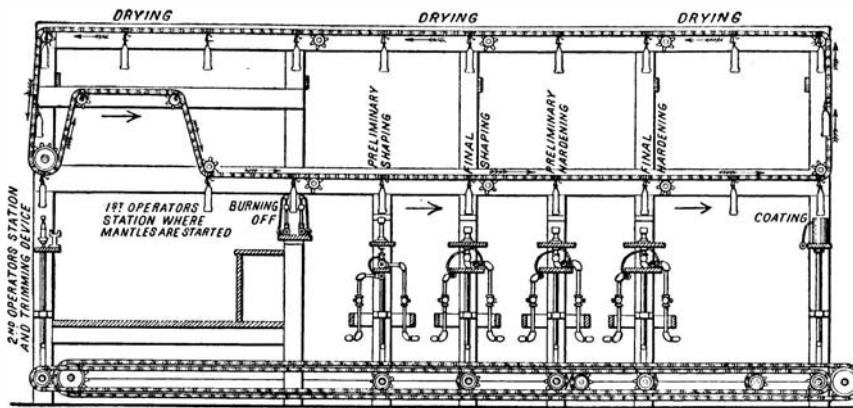

SIDE AND END ELEVATIONS OF THE AUTOMATIC INCANDESCENT MANTLE-MAKING MACHINE, AND A MANTLE WITH A RING, THE DOTTED LINES SHOWING THE AMOUNT OF SHRINKAGE.

after this, to another set of burners by which the upper portions are shaped; next, to a set of burners by which the mantles are hardened, and finally to a series of cups containing a coating solution, into which the mantles are dipped. Now practically complete, the mantles are elevated to the top of the framework of the machine, travel slowly toward the second operator, drying as they travel, and finally reach her,

whatever breakage does occur is due to the carelessness of the operator. Rarely is a mantle lost. The uniform excellence of the machine-made mantles, moreover, cannot be attained even by the most skillful operator.

DOMESTIC BATH PLUMBING.

Throughout the country districts, one of the great needs of the residences—a convenient bathtub—is seriously felt. The absence of this adjunct is felt in every household; for there are no water mains in the roadways, no sewers to carry away the waste, no gas to heat the water. As for heating the water by the tea-kettleful on the kitchen stove, and carrying it to the tub, that is too tiresome, and destroys the anticipated pleasure.

In the accompanying illustration it is shown how up-to-date facilities for a bath may be secured at a reasonable cost; given, first, a good soft water supply from well or cistern near the house, and secondly, deftness of the householder's hands to screw the pipes together, from the water supply to the tub. All of these conditions fell to the lot of the writer in his country house, within twenty miles of New York city; and the illustrations show how the idea may be realized without the aid of a plumber.

The cost (completed as shown) to the writer, was a trifle less than \$75. This outlay, for a permanent luxury, seems easily within reach of many on farm or roadside.

Having decided upon the location of the tub, in the interior of the house, measure accurately the distance from the water supply, where a 1 1/4-inch water pipe can be laid, under the ground, through the side of the house or cellar, up to the floor on which the tub is to be located, and thence to an outlet into a suspended metal tank holding 30 gallons of water, and an additional pipe reaching from the bottom of the first tank to an auxiliary tank, as shown, having a capacity of about 20 gallons. The necessary elbows, stop cocks and waste cock for emptying the pipe of water during the winter's cold must also be allowed for. Send these measurements, with a rough diagram of the different courses and turns of the pipe, giving the lengths of each course in feet and inches, to some large plumbers' supply dealer for estimate of cost, including a porcelain-lined tub and copper-bottom, galvanized tank, the estimate to include threaded ends of pipe, threaded elbows, and cocks, all ready to screw together. The tanks for water should be for the larger 14 x 16 x 31 inches, the other 14 x 16 x 20 inches, cross-braced on the inside both ways to prevent bulging, a "tell-tale" 1/2-inch lead pipe soldered into a hole 1 inch from the top and long enough to pass through the side of the house, to overflow

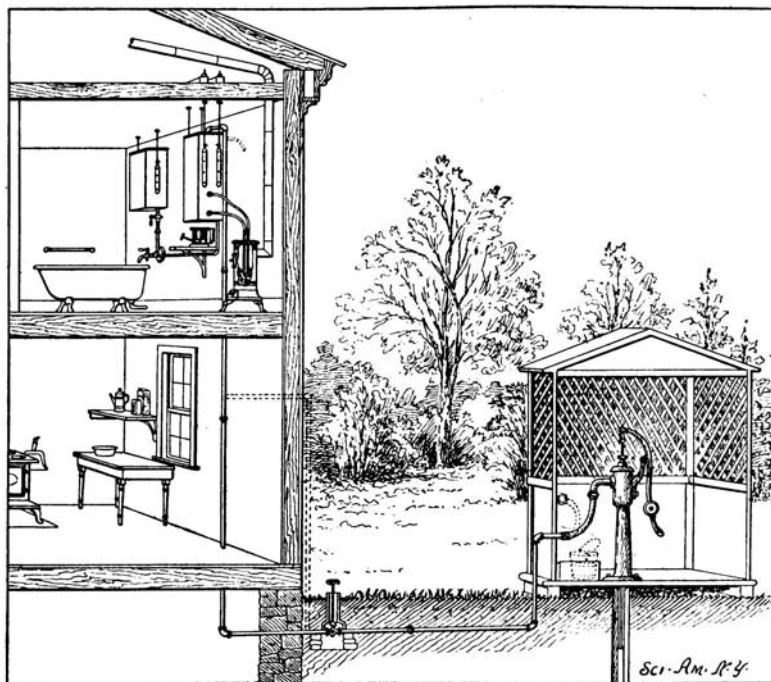

METHOD OF OBTAINING HOT WATER IN A COUNTRY BATH-ROOM.

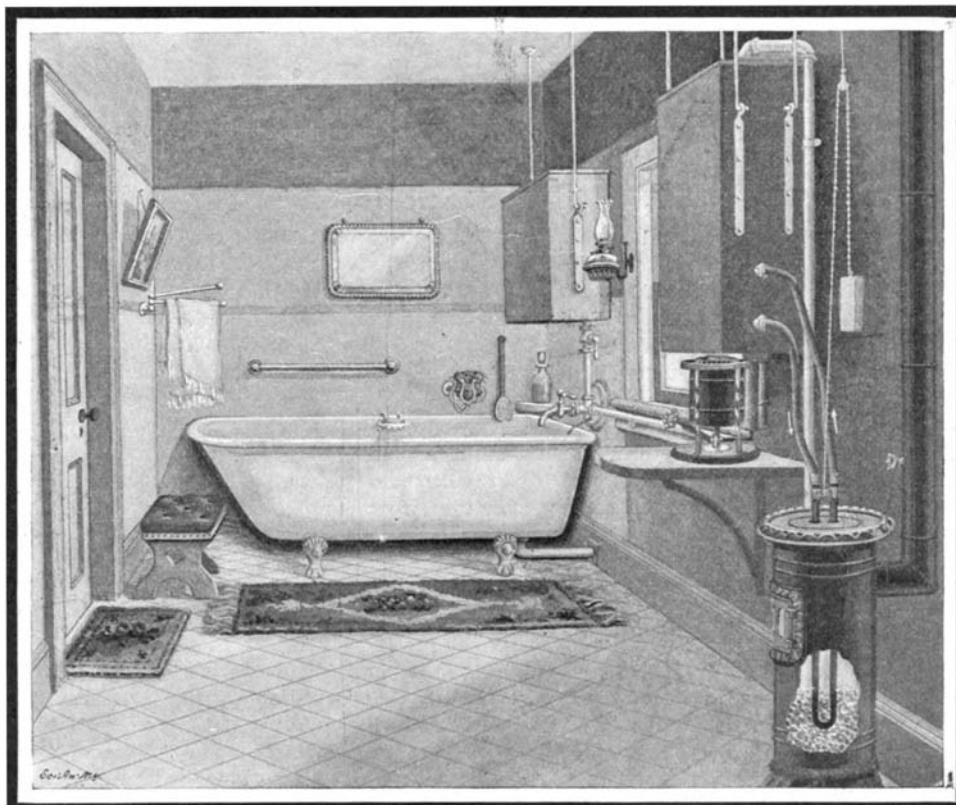

THE BATH-ROOM AND THE WATER HEATER.

when full, and ears on the sides, as shown, for suspension to $\frac{1}{4}$ -inch hooks that pass up through ceiling and bolt through crosspieces of wood, resting on the garret joists.

The tub shown is 5 feet long, of the usual standard make. Have a piece of lead pipe 3 feet long, soldered to the bent outlet of the tub, to run the waste water out of doors; suspend the tanks as shown, with their tops on the same level, so that both tanks may fill at the same time; then close the cock in the pipe to the smaller tank, keeping the cold water in it to temper the hot water when it is run into the tub.

The connection of the iron water pipe with the pump is accomplished by the use of a piece of rubber hose, to one end of which the usual "force and lift pump" coupling is attached, the other end being wired on to the iron water pipe terminal. The hose may be loosened from the pump and held aside on a hook, to permit the usual uses of the pump.

The larger tank of water is heated by a single blue-flame, wickless kerosene heater. If there be a small stove in the room, used ordinarily, for keeping the chill out of the room in the winter time, a portion of the heat of the fire may be utilized to heat the water, without using the kerosene heater. This is done by having a piece of $\frac{1}{2}$ -inch iron water pipe, 40 inches long, bent over like a hairpin, and having two rubber-hose connections with tank, by means of two unions, located, one near the bottom and the second a few inches above it. This insures circulation, and very hot water in the winter, when the bent pipe has been lowered into the fire, through hole or holes in the stove cover, as shown. With either of these two arrangements of water heating, both simple, and of little expense, any temperature of water desirable for bathing purposes may be had. When all is in complete working order, as pictured in our illustrations, many happy hours may be healthfully passed in its pool. It is probably unnecessary to call attention to the many accessories which add to the comfort of the bather; such as the movable soap dish, sponge holder, holding bar, towel rack, looking glass, etc.

A NOVEL RESPIRATORY APPARATUS.

BY EMILE GUARINI.

In mine explosions, in emanations of fire-damp, in catastrophes like that of the Metropolitan Railroad of Paris, and in many fires, it is not the heat of the flames, but asphyxia, that claims the greatest number of victims. In order to enter irrespirable gases, the life-saver has up to the present had no other resource than to connect himself with a tube through which air was pumped to him from the exterior, just as it is pumped to the diver. This system presents great drawbacks, and, when the distance to be traveled is considerable, the pipe becomes heavy and may become obstructed by bends, folds, etc. It is, therefore, but natural that an effort should have for a long time been made to devise an apparatus, which, by permitting a person to carry upon him a sufficient quantity of air to allow him to live for a certain length of time in any sort of atmosphere, should render him independent of the external air.

The first thing that suggested itself was the use of compressed air, and Lieutenant of Engineers Vaginot devised an apparatus that constituted a very great improvement upon all previous ones by permitting life-savers to greatly increase their sphere of action. This apparatus consisted of a reservoir of compressed air which the life-saver utilized for his respiration, and regularly expelled to the exterior the air respired. It permitted him to remain for ten or twelve minutes in any kind of irrespirable gas whatever. Physiology teaches us that in the air that we breathe (composed of 79 per cent of nitrogen and 21 of oxygen) the nitrogen plays no part in the exchange of respiratory gases. It is, therefore, useless to overload the life-saver by storing up nitrogen under pressure, for, while a tube of 35 cubic feet of compressed air weighs 30 pounds, a tube of oxygen of 7 cubic feet, which permits of living just as long, weighs but 5. On the other hand, we know that our blood absorbs only 4 per cent of the oxygen that enters our lungs, the remaining 96 per cent being expired without having been utilized.

The fact, based upon the experiments of Regnault and Reiset, and which Dr. Guglielminetti's new apparatus has clearly confirmed, is, that if the eliminated carbonic acid be absorbed by potash, and the oxygen be replaced in measure as it is consumed, a limited quantity of nitrogen may be used for respiration for an indefinite length of time.

In the Guglielminetti apparatus, the pure compressed oxygen is contained in a small receptacle provided with an expander and a meter for indicating the quantity of gas remaining in the former. The expanded oxygen is discharged at the rate of 120 cubic inches a

minute, and flows automatically through a tube to the mouth of the life-saver. The escapement pressure is sufficient to allow the air expired into a respiratory bag to be drawn by the current of oxygen as by a Giffard injector, through a regenerator containing granulated caustic potash, which absorbs all the carbonic acid eliminated. The air, thus purified, having been heated in its formation, passes into a refrigerating apparatus and afterward becomes charged with oxygen by its passage in front of the aspiration device. It is thus possible for a person carrying the apparatus to remain for 25 or 30 minutes without danger in an absolutely deleterious medium; but, after the expiration of this time, since the air contained in the apparatus has become heated to 98 or 100 deg. F., the individual is less at his ease, although neither syncope nor any other accident supervenes any more than when hot air is inhaled in a Turkish bath. In practice, the apparatus is capable of operating uninterruptedly for two hours if two oxygen tubes are employed.

The important point is that all the carbonic acid expired shall be absorbed by the potash, that the oxygen shall be renewed in sufficiently large quantities, and that the person carrying the apparatus shall, without the least effort, breathe as freely as in the open air.

The accompanying figures give a diagram of the apparatus and two views of it. Fig. 2 gives a front view of the apparatus, while Fig. 3 shows an apparatus specially designed for firemen, the mouthpiece here being held between the lips, the nose being closed by

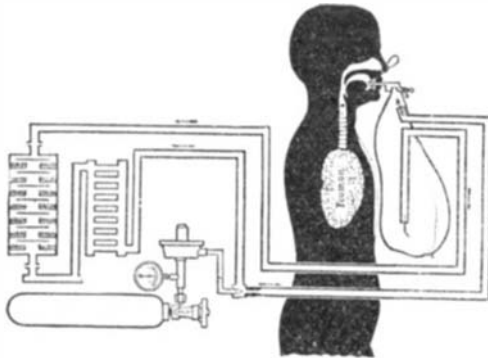

Fig. 1.—Diagram of Respiratory Apparatus.



Fig. 2.—Front View.

Fig. 3.—Apparatus for Firemen.

THE GUGLIELMINETTI-DRAEGER RESPIRATORY APPARATUS.

pincers, and the helmet being discarded as useless.

In conclusion, we may state that the apparatus weighs but 22 pounds, inclusive of the helmet, and that the firemen of Paris, who have placed it upon trial, have been fully satisfied with the results obtained. The inventor is at present studying the application of the apparatus to diving.

Life-Saving Bag and Box.—The object of these apparatus, both of which contain a small 4-cubic-foot tube of oxygen, is to permit of the direct respiration of oxygen from the compression tube, to which is secured an expander that accurately regulates the discharge of the gas, a pressure gage that always shows exactly the quantity that remains in the tube, and a metallic mask provided with a Cailletet valve for expiration, and that permits of fixing the mask upon the face of an asphyxiated person. It is thus possible to combine oxygen inhalation with artificial respiration and, thanks to a mask for the nose, with rhythmic tractions of the tongue. We wish to dwell particularly upon this latter arrangement, which is of great importance, since in many cases traction of the tongue in the asphyxiated brings about a beginning of respiration,

which is not kept up. If, at this moment, the patient be made to absorb oxygen instead of air, we know from the experiments of Grehaut that he will have many chances for his life. As he cannot utilize the oxygen during expiration, a small bag of gold-beater's skin interposed between the tube and the mask forms a reservoir into which the oxygen flows during the expiration.

This apparatus is therefore always ready for operation, and easily carried to a place of accident, either by hand or upon a bicycle. This is a very important matter in cases of asphyxia, in which a gain of a few minutes may often save a person's life.

The 2,000,000-Mile Record Run of a Locomotive.

We have on more than one occasion drawn attention in these pages to the different practice of English and American railroads with respect to the retention of locomotives for a prolonged period of service. In this country, the general method is to run a locomotive for a limited number of years, and then to relegate it to the scrap heap in favor of a more modern type of engine. On the other side, however, the practice is to retain a locomotive in service as long as it will run, irrespective of the developments and improvements that may be incorporated in the progress of time. The result is that upon the English railroads may be seen engines still in hard use, which we should consider long past their term of service. Yet no English engine has attained the unique distinction achieved by the locomotive No. 955, "Charles Dickens," upon the London and Northwestern Railway, which has covered close upon 2,100,000 miles, in the haulage of express trains.

This engine issued from the Crewe engineering shops of the railroad on February 6, 1882, and has been engaged in the London-Manchester service regularly every day, except in those periods in which it was undergoing overhauling, ever since. This locomotive is fitted with cylinders of 17 inches diameter and having a stroke of 24 inches. The driving and trailing wheels are of 6 feet 6 inches and leading wheels 3 feet 6 inches diameter. The mean diameter of the boiler outside is 4 feet 1 inch and length of barrel 9 feet $9\frac{3}{4}$ inches, with a heating surface of 194 tubes, yielding an area of 960.2 square feet, and a firebox heating surface of 103.5 square feet. The boiler pressure is 150 pounds per square inch. The weight of the engine in working order is as follows:

On leading wheels, 10 tons 12 hundredweight; on driving wheels, 12 tons 10 hundredweight; on trailing wheels, 12 tons 10 hundredweight. The tender has a water capacity of 1,800 gallons and a coal capacity of 3 tons. The total weight of the engine and tender in working order is 60 tons 12 hundredweight.

This locomotive was installed upon the express service, hauling the train leaving Manchester at 7.45 in the morning, and returning with the train out of London at 4 P. M. the same afternoon, thus covering 387 miles a day. The engine ran regularly in all weathers without the slightest mishap. On the 2,651st round trip it recorded the remarkable feat of having run 1,000,000 miles, covered in 9 years and 219 days. During this time 12,515 tons of coal were consumed, and 93,237 tons of water were evaporated. During 11 years' service but few repairs had to be effected, the most important being the supply of two new sets of "digestive organs." Even these, however, were by no means worn out when discarded, for they were immediately installed in the sister engine "Snowdon," which covered 191,236 miles with them, and then yet a third locomotive, "Balmoral," appropriated them, and ran with them for many years. The second set, after replacement, were placed in the engine "Courier," and were satisfactory for several years.

The locomotive "Charles Dickens" continued with the same express, and on the 5th of August, 1902, during the 5,312th round trip from Manchester to London, notched its 2,000,000 miles, a feat which has not been paralleled on any other railroad in any other part of the world. Notwithstanding the extensive improvements and developments that had been effected in the 20 years and 181 days that had elapsed during the covering of this enormous mileage, this engine still remained one of the fastest and most punctual upon the road.

During the latter part of this time, however, there was a great change in the character of the rolling stock. Dining and sleeping coaches were introduced, which considerably increased the weight of the train. Furthermore, the requirements of faster traveling necessitated the engine being appreciably speeded up. This was gradually done up to 50.1-3 miles per hour.

During this 2,000,000 miles, the engine consumed 27,486 tons of coal and 204,771 tons of water. The fuel consumption, including the raising of steam, has not

once exceeded 32 pounds per mile, while the cost of maintaining the engine in working efficiency has averaged 3.56 cents per mile run. Owing to the system of standardization which is a feature of the Crewe Works, the enforced idleness of the engine consequent upon renewals and repairs has only averaged 12 per cent of working time. This huge mileage has been covered without the slightest mishap of any kind. Although the speed of many trains upon this system has been considerably augmented during the past few years, yet this express hauled by "Charles Dickens" still remains one of the fastest upon the system, and owing to the present excellent condition and running of the locomotive, it will probably still be retained upon the 387-mile daily run for some time to come.

LAUNCHING OF THE "CONNECTICUT" AND "MILWAUKEE."

On September 29, eighteen months after the laying of her keel, the United States battleship "Connecticut," which shares with the British battleships of the "King Edward" class the distinction of being the largest yet constructed, was launched at the New York navy yard, Brooklyn. The event was marked by the customary ceremonies, and it was witnessed by a great crowd of visitors, who had been admitted to the grand stand and inclosures of the navy yard by tickets of invitation. It is an historical fact, deserving of mention in this connection, that the "Connecticut" was launched from the very spot at which the old prison ship "Jersey" was beached, after she had performed her notorious duties during the Revolutionary war; and when the piling was being driven for the building ways, no little difficulty was experienced in getting it down through the remains of the sunken vessel.

The "Connecticut," and the sister ship "Louisiana," which was launched a month ago at the Newport News yard, were authorized by act of Congress on July 1, 1902, and under the terms of the act the contract for one of these vessels was to be let to a private firm, and the other ship was to be built in a government yard. The determination of Congress to renew the practice of building warships at the navy yards was brought about by the urgent representation of the Navy Department, which claimed that with its present plant and fine organization, such a yard as that at New York was thoroughly equipped for the speedy and economical construction of warships. Consequently, the construction of the "Connecticut," being undertaken at the same time as that of the "Louisiana," has been watched with the keenest interest; and it is extremely gratifying to the government that she should have been completed in practically the same space of time as the contract-built vessel.

The "Connecticut" is 450 feet in length on the waterline, 76 feet 10 inches in beam; and when the ship is fully equipped ready for sea, with all stores on board and a normal supply of coal in the bunkers, she displaces 16,000 tons on a draft of 24 feet 6 inches. Her full load displacement with her bunkers filled and stores aboard for an extended cruise is 17,666 tons. She is propelled by twin-screw, vertical, triple-expansion engines, of 16,500 indicated horse-power, which are designed to drive her at a speed of 18 knots an hour. The normal coal supply is 900 tons, but her bunker capacity is 2,200 tons. When the ship is fully loaded, her maximum draft aft is 26 feet 9¼ inches. Her boilers are of the Babcock & Wilcox type, and she carries enough coal to enable her to steam at a speed of 10 knots an hour continuously for a distance of 5,275 miles.

Officially, the "Connecticut" is known as a sea-going battleship with two 12-inch and four 8-inch barbette turrets. She is remarkable for her great offensive and defensive powers, in both of which she is unexcelled by any foreign ship. All of her armor is of the best Krupp face-hardened type. The protection consists of a waterline belt, which extends from stem to stern. For one-third of her length amidships, the belt is 11 inches thick at the top and 9 inches thick at the bottom, and from these dimensions it tapers fore and aft to an even thickness of 4 inches at the bow and stern. Above the main belt, and for the distance between the main barbettes, there is a continuous wall of side armor 7 inches in thickness reaching from the main belt to the main deck. At the ends of this armor, bulkheads of 7-inch armor extend athwartship to a connection with the main barbettes. There is a continuous protective deck, which is 1 inch thick on the flat and 2½ inches thick forward and aft, the thickness of the side slopes being 3 inches. The main barbettes are protected by 10 inches of armor, and the main turrets by 12 inches. The four turrets of the 8-inch guns are protected by 8 inches of armor, while the barbettes below carry 6 inches.

The unusually powerful battery is composed of four 12-inch 40-caliber guns in two turrets fore and aft, eight 8-inch 45-caliber guns in four turrets, two on each broadside, the two forward turrets having an arc of fire from dead ahead to a point well aft of

the beam, and the after pair of turrets is similarly able to fire from forward of abeam to dead astern. On the gun deck, and firing through casemates in the 7-inch side armor, is a powerful battery of twelve 7-inch, 50-caliber guns. The 7-inch gun is a new piece of high velocity and great penetration, that in these vessels takes the place of the usual 6-inch guns. This piece has a velocity of 2,900 feet a second and a muzzle energy of 9,646 foot-tons. It fires a projectile of 165 pounds with sufficient energy to penetrate 28.7 inches of iron at the muzzle. This is a great advance over the 6-inch guns which will be mounted on the "Georgia" class, the smaller weapon having the same velocity and firing a 100-pound projectile with a muzzle energy of 5,840 foot-tons and a penetration of iron at the muzzle of 24.2 inches. The armament also includes twelve 3-inch 14-pounder rapid-fire guns, six of them mounted on the gun deck, two in the bow and four at the stern, and firing through casemates protected by 2 inches of armor, the other six being mounted on the main deck in broadside between the 8-inch gun turrets, with 2 inches of protection on the casemates. There are also twelve 3-pounders and fourteen machine guns distributed on the roof of the turrets, the superstructure, the bridges, and in the fighting tops. The forward conning tower, which incloses the base of the military mast, is protected with 9 inches of Krupp steel, and the after conning tower, sometimes known as the signal tower, which is located beneath the after bridge, has 5 inches of protection. As originally designed, the "Connecticut" does not carry any submerged torpedoes, but in consequence of agitation of the subject it was subsequently decided to provide her with four such tubes, two located in a compartment forward and two in a compartment aft, in a position slightly forward and aft, respectively, of the 12-inch turrets.

Although she is not such an important vessel as the "Connecticut," the "Milwaukee," of 9,700 tons displacement, which was launched on the tenth of the same month at the yards of the Union Iron Works, San Francisco, is a vessel which a few years ago would have excited widespread attention.

She is a twin-screw protected cruiser, and a sister ship to the "St. Louis" and the (new) "Charleston," now building at the yards of Neafe & Levy and the Newport News Shipbuilding and Dry Dock Company. The dimensions of the "Milwaukee" are: Length on normal load waterline, 424 feet; breadth, extreme, 66 feet; mean draft, 22 feet 6 inches; displacement, about 9,700 tons; speed, 22 knots; bunker capacity, 1,500 tons.

The "Milwaukee" will have a protective deck of nickel-steel the entire length of the ship, 1½ inches thick on flat and 2½ inches on slopes. The nickel-steel plates are laid on ½-inch steel plating, giving the deck a total thickness of 2 and 3 inches. The main side armor belt is 7 feet 6 inches wide and 4 inches thick, and is placed abreast of boilers and engines for a distance of about 196 feet. Above the main belt is the lower casemate, with a uniform thickness of 4 inches, protecting the central portion of the hull for a distance of about 196 feet, and extending up to the gun deck. Above the lower casemate is the upper casemate, with a uniform thickness of 4 inches, protecting the central portion of the hull for a distance of about 136 feet, and extending up to the main deck. At each end on the berth and gun decks, and worked in to meet the ends of the side armor, is athwartship armor 3 inches in thickness. There will be worked in from the protective deck to above the waterline the usual cellulose cofferdam.

The main battery consists of fourteen 6-inch breech-loading rapid-fire rifles of 50 calibers in length. Of these, six are mounted on the main deck, and eight are mounted on the gun deck. The secondary battery consists of eighteen 3-inch breech-loading rapid-fire rifles, of 50 calibers in length; twelve 3-pounder semi-automatic guns; four 1-pounder automatic guns; and eight 1-pounder rapid-fire guns; there are also two 3-inch field guns, two machine guns 0.30 caliber, and eight automatic guns 0.30 caliber.

The "Milwaukee" will have twin engines of the vertical, inverted-cylinder, direct-acting, triple-expansion type, each with a high-pressure cylinder 36 inches, an intermediate-pressure cylinder 59 inches, and two low-pressure cylinders 69 inches in diameter; the stroke of all pistons being 45 inches. The order of the cylinders, beginning forward, is: Forward low-pressure, high-pressure, intermediate-pressure, and after low-pressure. The framing of the engines consists of forged-steel columns trussed by forged-steel stays; the bedplates are of cast steel. The indicated horse-power of both engines will be 21,000 when making about 133 revolutions per minute and with steam pressure of 250 pounds at the throttle. The designed speed on trial is 22 knots.

There will be sixteen boilers of the water-tube type, placed in four water-tight compartments forward of the engine rooms; the forced draft system will con-

sist of blowers discharging into closed ashpits, there being one blower for each boiler. There will be a complete electric plant on board, consisting of two 150-kilowatt and three 50-kilowatt generators, direct-connected to compound engines, using steam at 150 pounds. Over 78 electric motors will be installed, of from one to thirty horse-power; they will be used to operate boat cranes, deck winches, blowers for ventilation, ammunition hoists, etc.

The "Milwaukee" will have a complement of 645 officers and men.

A few years ago the "Milwaukee" would have ranked as an armored cruiser; but to-day, because of the unprotected ends at the waterline, and the weakness of the side armor (only 4 inches in thickness), she is classed in the navy list only as a protected cruiser.

Automobile Notes.

The crowning racing event of the year in this country will take place on Long Island, October 8. The race is known as the Vanderbilt Cup race, and it is an international race for a trophy presented by Mr. William K. Vanderbilt, Jr. It will be run on a 30.24-mile course, which will be traversed ten times by the competing cars. Some of the best European cars are found among the eighteen entries, while but few leading American makes are represented. Among the latter are two 60-horse-power Pope-Toledo racers, the Packard 30-horse-power "Gray Wolf," a 30-horse-power Royal Tourist, and a 75-horse-power Simplex. The French team consists of three 90-horse-power Panhards and one Renault of the same power, besides a De Dietrich and a Clement-Bayard 80-horse-power car. Five 60-horse-power Mercedes cars will represent Germany, and two 90-horse-power Fiat machines Italy. In order to entirely do away with dust, the course will be thoroughly sprinkled with oil throughout the entire distance, and it is estimated that 100,000 gallons of crude petroleum will be needed for this purpose. The course has a number of very sharp turns, which it will require skillful driving to round without mishap.

A 614-mile reliability test of light cars has just been held in England. The test consisted of a 50-mile run out from Hereford and back again, or 100 miles in all per day, besides hill-climbing, stopping, and starting on grades as high as 15 per cent. Twenty minutes was allowed each morning for adjusting the cars. Out of thirty-eight cars that started, twenty-six finished successfully, while but four managed to make absolute non-stop runs throughout. Of these, two were 6-horse-power Wolseley and Siddely cars, which sell for about \$875 each; and the remaining two were a 6-horse-power De Dion and an 8 to 10-horse-power Croxton, valued at \$1,000 each. Nearly all of the cars were of the light, two-passenger type. Besides the four cars mentioned, four others—a 6½-horse-power Wolseley, two 7½-horse-power Humbers, and another 6-horse-power De Dion—made eleven out of a possible twelve non-stop runs. The two Wolseleys and the two De Dions were run as teams, and it speaks very well for the former that but 10 minutes time was lost between them during this long road test, while the only troubles with the De Dion cars happened to the second one, driven by Miss Dorothy Levitt, which was detained an hour and a quarter during the last 50-mile run by the needle-valve sticking in the carbureter. The trials have shown very well the possibilities of the runabout automobile for touring purposes, and have again demonstrated the reliability and lack of tire trouble which are the features of this type of car.

The Current Supplement.

The current SUPPLEMENT, No. 1500, is opened with an excellently illustrated article by our St. Louis correspondent entitled "The United States Commission of Fish and Fisheries Building." Of technological importance are an instructive contribution on the practical production of bronze leather, a *résumé* of the action of explosives, and a very exhaustive paper on artificial stone. Mr. Harold Busbridge writes on the shrinkage and warping of timber, illustrating his opinions with many striking illustrations. "Art and Engineering" is the title of a discourse upon a subject of considerable importance, in so far as it affects American municipalities. Prof. Robert MacDougall outlines in an interesting way the evolution of the human hand. The Porta Volta electric supply station of Milan is noteworthy, in so far as it embodies a 5,000-horse-power three-phase turbo-alternator of new design. A fully illustrated article on the plant is published in the SUPPLEMENT. The Prime Minister of England, Mr. Henry A. Balfour, delivered a splendid address before the British Association for the Advancement of Science, a discourse in which he outlines the development of modern anthropology. One of those practical articles in which the construction of experimental apparatus is described, and for which the SUPPLEMENT is noted, is also published. It bears the title, "The Construction of an Indicating or Recording Tin Plate Aneroid Barometer." It is written by Dr. N. Monroe Hopkins.

LOCOMOTIVE HISTORY AT THE WORLD'S FAIR, ST. LOUIS.

BY HERBERT T. WALKER.

Not the least important and interesting section of the Transportation Exhibit at the World's Fair at St. Louis is the remarkable collection of old locomotives, that present a graphic history of the development of transportation by steam from its earliest inception down to the present day.

It will be remembered that some time prior to the opening of the Columbian Exposition in 1893, Major J. G. Pangborn, representing the Baltimore & Ohio Railroad Company, visited Europe and acquired a large number of drawings and other data of early loco-

thus supplying the missing links, and forming a chain of locomotive history that is practically complete, presenting the matter to the student in a way that enables him to grasp the subject as no written work would do.

The history of the locomotive is a difficult and complex subject, and one, moreover, that has never been written in book form. The value, therefore, of this historical display, from an educational standpoint, can scarcely be overestimated.

It would be impossible to do justice to the elaborate exhibit, now at St. Louis, within the limits of a single notice; and, as illustrated articles on these historical locomotives have appeared in this journal from

ton's suggestion, made in the year 1680, for a vehicle to be propelled by a jet of steam working on the reaction principle utilized in the famous Turbine of Hero of Alexandria in the year 150 B. C. It is needless to say this idea was never put into practical form.

The next exhibit is an enlarged reproduction of Murdock's road locomotive of 1784, and is the first engine shown in Fig. 2. Murdock's engine was a small brass model, which worked satisfactorily on a table or floor; but the reproduction at St. Louis is made larger, and, as seen in Fig. 6, the figure of an engineer has been placed thereon. Murdock's engine had but three wheels, and was worked by a single cylinder and a grasshopper beam.

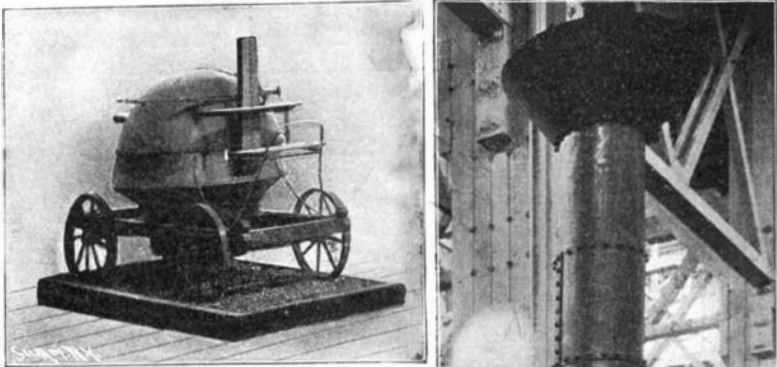

Fig. 1.—Sir Isaac Newton's Proposed Locomotive, 1680.

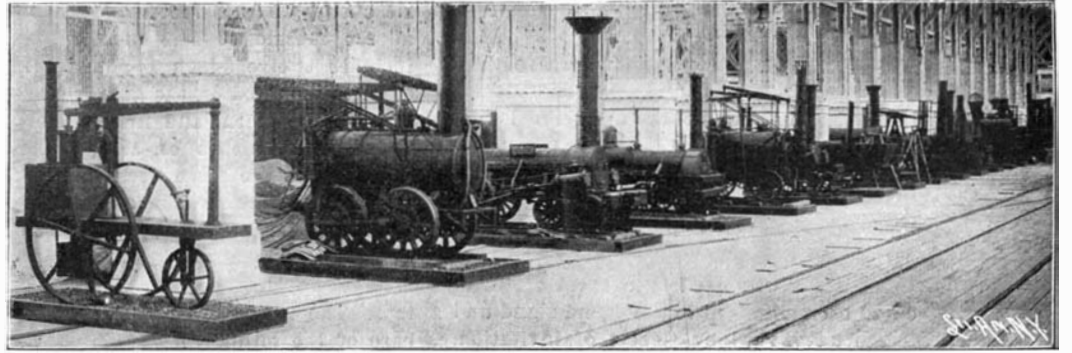

Fig. 2.—A Portion of One Line of the Historical Exhibit at the World's Fair.

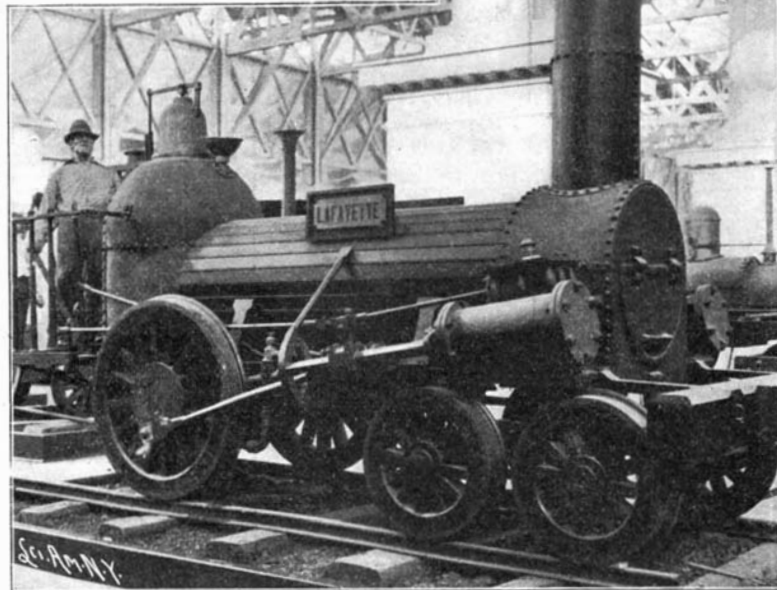

Fig. 3.—Typical Norris Locomotive of 1837.

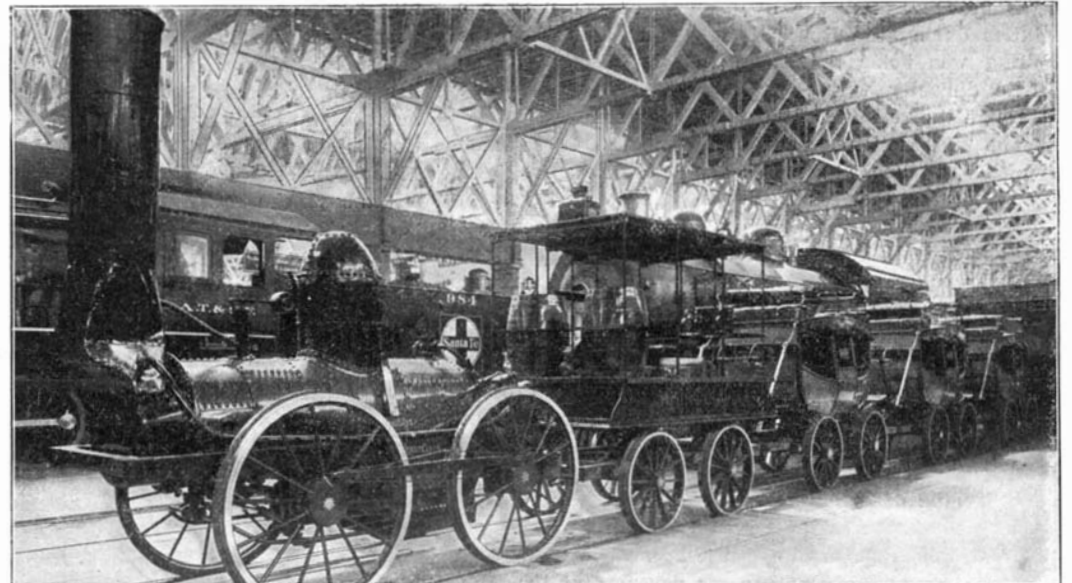

Fig. 4.—"De Witt Clinton" and Train, 1831.

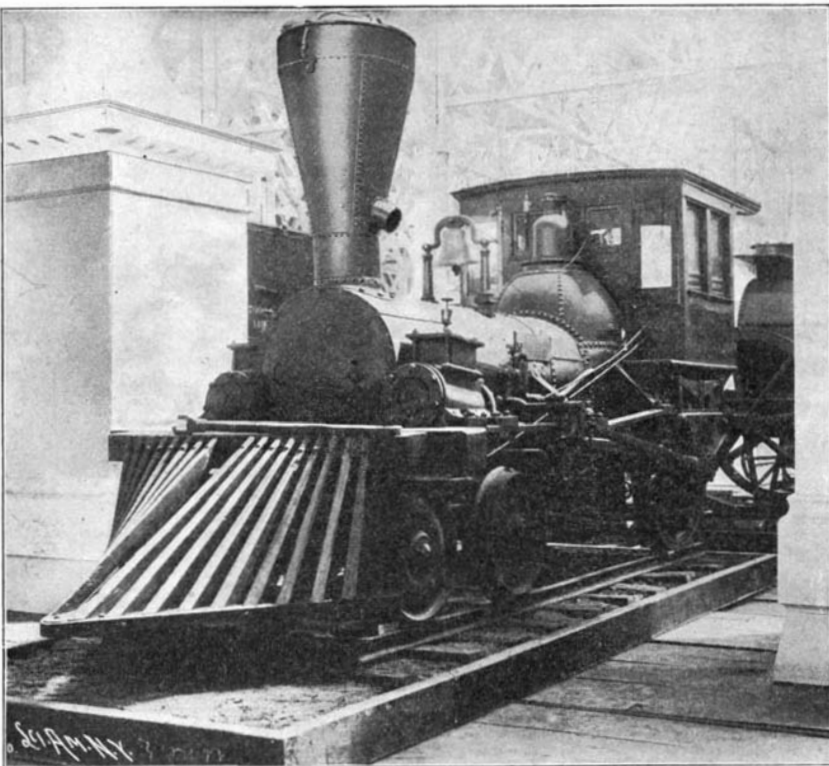

Fig. 5.—The First Locomotive in Chicago, 1848.

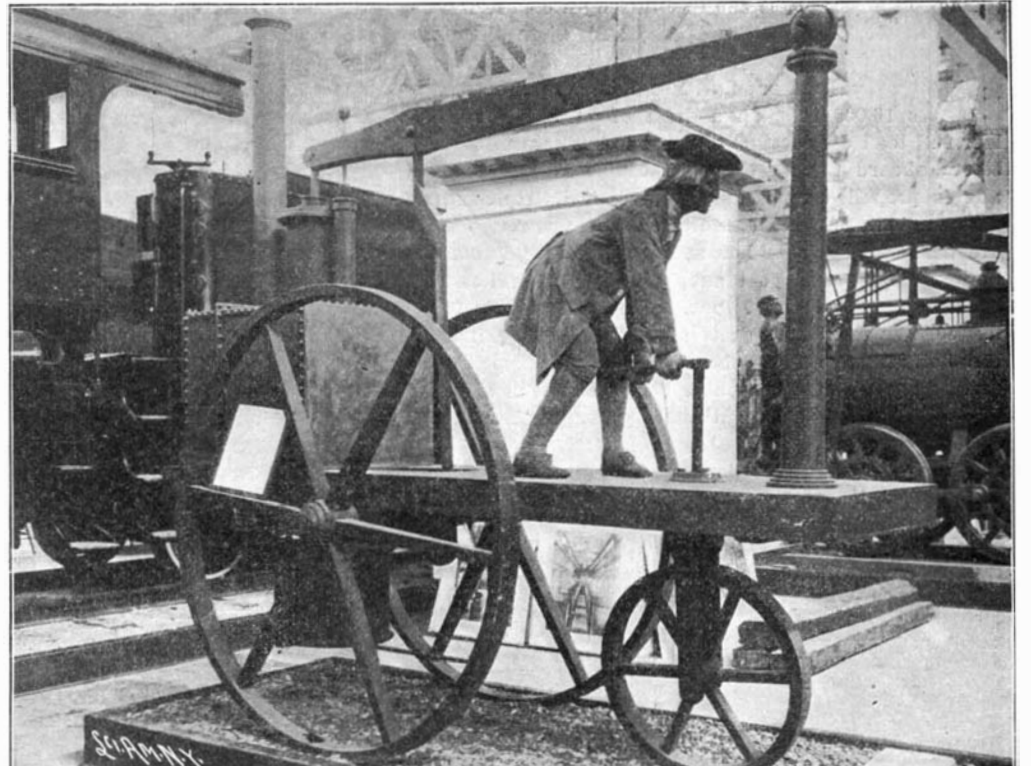

Fig. 6.—Murdock's Road Locomotive, 1784.

LOCOMOTIVE HISTORY AT THE WORLD'S FAIR, ST. LOUIS.

tives. He also secured like material from the railroads and engine builders of the United States; and from this rich mine of information, full-size reproductions of nearly all the types of locomotives were constructed. Furthermore, wherever possible, specimens of real locomotives were secured, and these with the full-size reproductions formed, at Chicago, a unique exhibit which presented an almost unbroken chain in the history of the locomotive engine.

On the closing of the Columbian Exposition, the collection was removed to the Field Museum, and thence it was recently transferred to St. Louis, at which time additional historical material was collected,

time to time, it will suffice for the general reader if we glance at a few of the more noteworthy examples.

Before describing the engines which we illustrate, mention should be made of the fact that all the engines stand upon either the original or the exact counterpart of the track of their period; and that, in many instances, lifelike figures of the contemporary enginemen have been mounted on the footplates.

These two features of the engines lend additional historical flavor to this most valuable collection.

Fig. 1 of the accompanying illustrations shows the commencement of one line of the Historical Exhibit, and the object before us is a model of Sir Isaac New-

The second engine, appearing in Fig. 2, is a full-size reproduction of the "Stourbridge Lion," the original of which was built in England in 1828, and was run on the Delaware & Hudson Canal Company's railroad. This engine had grasshopper beams, and was the first locomotive to turn a wheel in the United States.

We next observe "La Fayette" of 1837. This was one of the first Norris locomotives that had adhesion sufficient to surmount heavy grades, and, as seen in Fig. 3, a figure of an engine driver with one hand on the throttle lever and the other holding the reversing lever has been placed on the footboard, giving a realistic finish to this pioneer American engine, which, with

its drop "D" hook motion and dome firebox, will repay careful study.

The fourth engine shown in Fig. 2 is the "Experiment," designed by John B. Jervis in 1832 for the Mohawk & Hudson Railroad. It was the first engine to have a swiveling truck—a feature of the American locomotive that has helped to make it so successful.

Then follows in the line the "Puffing Billy," a celebrated English locomotive designed by Blackett and Hedley in the year 1813, for hauling coal trains on the Wylam Colliery Railway, Newcastle-on-Tyne. It has upright cylinders and grasshopper beams, similar to the "Stourbridge Lion," already noticed.

The rest of the engines shown in this illustration become too indistinct in the perspective to be clearly seen, but among them will be found Eastwick and Harrison's "Hercules" of 1837-38, the first locomotive to have equalizing levers; the first American eight-wheel engine, designed by Campbell in 1836; James' engine of 1832, the first engine in the world with link motion, and many others of equal interest. Limitations of space forbid more than a brief reference to one of Ross Winans' celebrated "Camel" engines, that astonished the railway world fifty years ago with its great hauling power. We must not, however, pass by a full-size reproduction of Stephenson's "Rocket" of 1829, which at the celebrated competition at Rainhill, England, attained a speed of 24 miles an hour. It possessed all the essential features of the modern locomotive, and is, perhaps, the most important historical locomotive in the world.

In other parts of the historical display will be found several engines worthy of notice, among them the "Pioneer" of 1848. (See Fig. 5.) This is a working locomotive. It was the first locomotive seen in Chicago, and ran on a railroad that is now a part of the Chicago & Northwestern system. It weighs about 10 tons, and has inside cylinders. The eccentrics are outside, and are fitted with drop "V" hooks. This feature alone makes the engine of special interest.

Perhaps the best specimen of a full-size reproduction to be found in the whole display is that of the "De Witt Clinton," which was the first engine to draw a train in the State of New York. The original was built for the Mohawk & Hudson Railroad, now a part of the New York Central & Hudson River Railroad, in the year 1831. This exhibit is complete, as it includes the tender and three passenger cars, and is illustrated in Fig. 4. It will be observed that these cars are built on the lines of the old stage coach. The baggage was carried on the roof, and an outside seat was provided for the guard or conductor.

Passing over the rest of the engines in this great exhibit, it may be said in conclusion that the Baltimore & Ohio Railroad Company have supplemented it by the addition of several modern locomotives of the most approved design, including the Mallet articulated compound engine, which has the distinction of being the heaviest locomotive ever built. It has four cylinders and twelve driving wheels arranged in two sets of six wheels each, the frame for the front set of wheels being pivoted to the rear section of the frame, thus enabling the engine to round the sharpest curves with ease. The total heating surface of this mammoth machine amounts to 5,586 square feet—the largest heating surface ever put into a locomotive. Its enormous power may be conceived in the drawbar pull of 70,000 pounds which it exerts when working compound, but when in simple gear the tractive effort reaches over 80,000 pounds. The weight of the engine in working order is 334,500 pounds.

A good idea of the great increase in the size and power of locomotives since Stephenson's time may be obtained by comparing his engine with the

First Stage—A Few Days After Hatching from Egg.

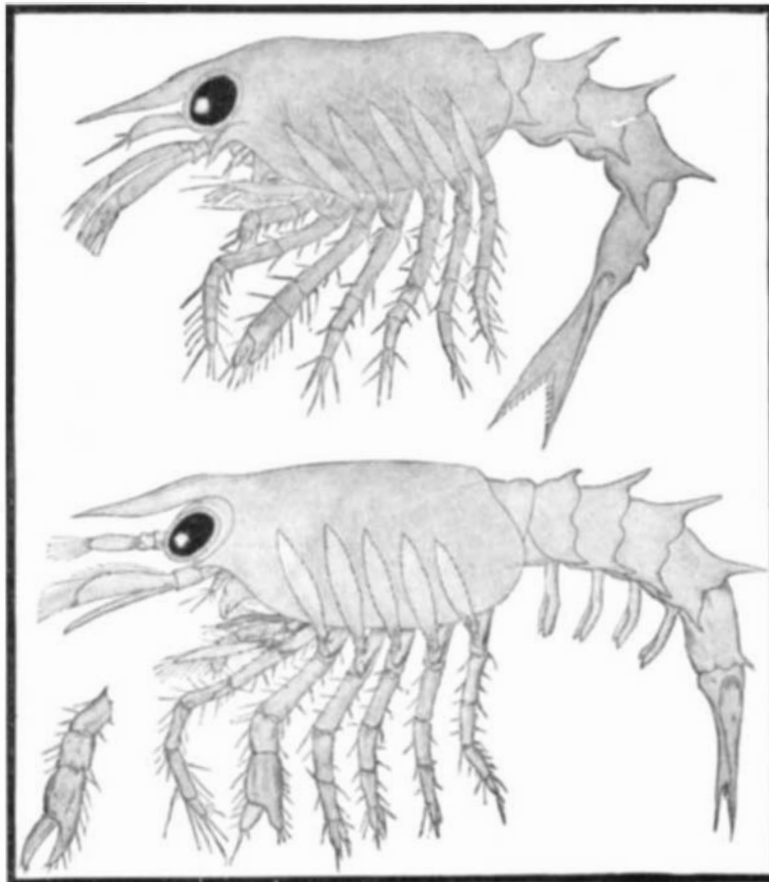

Second Stage in the Growth of a Lobster.

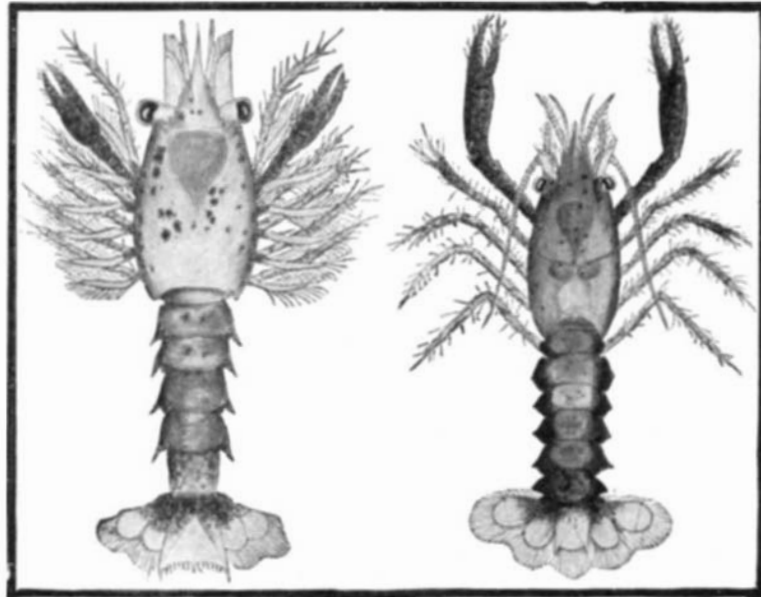

Third Stage—Nearing Maturity.

Fourth Stage (Last)—Young Lobster Ready for Liberation.

The Four Stages in a Lobster's Life.

one just described. The total heating surface of the "Rocket" was 137.75 square feet; its drawbar pull was about 785 pounds, and its weight in working order was but a little over 9,000 pounds.

It is gratifying to know that this valuable collec-

tion will not (as at one time seemed possible) be broken up at the close of the St. Louis Fair, arrangements having been practically completed for placing it in a permanent home in one of the eastern cities, with ample provision for its subsequent safe keeping.

ARTIFICIAL PROPAGATION OF LOBSTERS.

BY WALTER L. BEASLEY.

The artificial propagation of lobsters, one of the most interesting of biological problems, and of great economical importance to the United States, has been successfully solved. This noteworthy discovery, which has baffled scientists up to the present, has been practically worked out by the Rhode Island Commission of Inland Fisheries through the investigations carried on by Dr. A. D. Mead, of Brown University, who is director of the floating laboratory of the Commission at Wickford, R. I. The U. S. Fish Commission also co-operated in these experiments. For the past three years or more this has been anchored in Mill Cove and turned into a lobster experimental station, with specially-devised apparatus, and is to-day the first successful lobster-hatching plant in the world. New life is now assured to the declining lobster industry, which otherwise seemed doomed to extinction. The annual output is smaller each year, due partially to the unceasing trapping and reckless destruction of the female egg and short lobsters by certain of the crafty and ignorant fishermen, who fail to observe the regulations, and evade the fishing laws. It should be stated, however, that early experiments were carried on on behalf of the United States Fish Commission at Wood's Holl in 1899-1900 by Prof. Herman C. Bumpus, then director of the United States Biological Laboratory. His series of promising investigations awakened general interest in the artificial rearing of lobsters, and many different devices for the inclosures were tried, all of which proved unsatisfactory and resulted more in killing than in the rearing of the lobster fry. Later the experiments were transferred to the Wickford Station. The writer, in July of this year, at the Wickford Laboratory, had the opportunity of visiting the lobster-hatching plant, when Dr. Mead outlined the apparatus and his successful method of rearing the young lobsters from the eggs through the critical four stages of two to three weeks which is necessary before they become fitted for the struggle for existence. The following narrative embodies the salient and latest features of Dr. Mead's investigations, obtained from an interview and his official report. The hatchery is installed in a

house-boat, some fifty feet in length, built on two pontoons, having a house ten by ten on each end, which is used for a laboratory, sleeping apartments, and the storing of appliances. A well of twenty feet is arranged between the two houses. Two large floats on both

sides of the house-boat contain the essential apparatus for the breeding and rearing of the young fry. This, the most vital and important feature of the whole work, viz., the inclosure used to harbor the young fry, consists of a stout canvas bag twelve feet square, submerged to the depth of four feet and supplied with a rotating propeller. After innumerable experiments, it was found that the keynote to success was that the water in which the young fry were inclosed should be kept in continuous motion. This accomplishes two things: it prevents the fry from settling into pockets to smother or devour one another, and it keeps food in suspension, so that they can obtain it. In order to admit a free circulation of water in these bags, windows of copper screens are placed in the bottom and in the sides near the top. The bottom ones are twenty by thirty inches, through which the water enters the bag. The side ones are five feet long and ten inches broad, and placed ten inches from the top, through

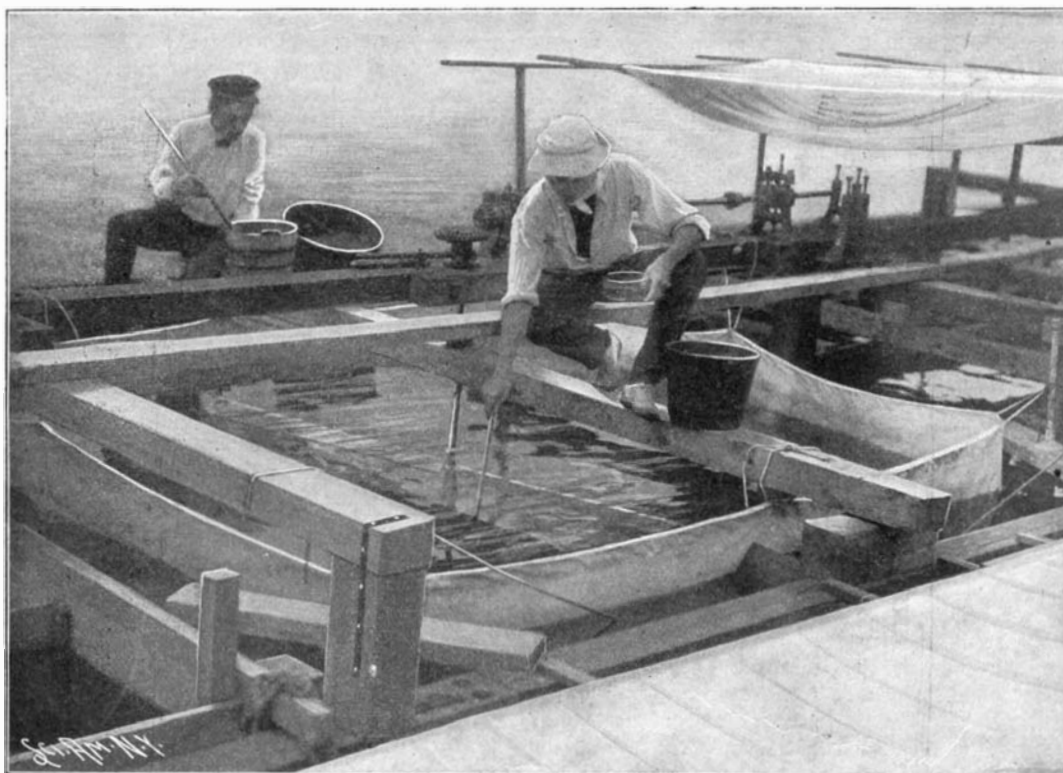

Submerged Bag with Stirrers for Breeding Lobsters. Getting Out "Fourth-Stagers" for Liberation.

which the water escapes in the bag. The windows are covered on the inside with linen scrim, which prevents the lobsters from being caught in the copper screen. The rotating propellers create an upward current through the bottom windows, which flows out through those on the side. The paddle blades are four feet long and operated by a gasoline engine, which turns the main shaft, revolving the whole series. The largest number of "lobsterlings" raised to the fourth stage at one time was 12,750, being over fifty per cent. In a series of experiments in which the fry were counted at the beginning and at the end, from sixteen to fifty per cent of the fry in the first stage were carried through to the required final fourth. In the experiment which yielded fifty per cent 1,000 specimens were used, with 2,500 forty per cent were carried through, and over twenty per cent in an experiment with 5,000, kept together in a small inclosure. A percentage of fifty-four was obtained in one case. Hitherto the best percentage under the old method and with most favorable conditions at Wood's Holl yielded only a quarter of one per cent. The Norwegian investigator Appellöf, who has recently conducted experiments, reports that by the use of the greatest precautions he succeeded in carrying over, out of 1,500 larvæ of the second stage, only one hundred individuals into the fourth, less than ten per cent. The first step in the artificial propagation is obtaining eggs from the female lobsters. These are bought from the Creek Newport fishermen in July and August. The eggs are carried through the winter and spring under the tail of the female, attached to the swimmerets, and the hatching begins in May and ends about the middle of July. The number of eggs produced varies with the size of the lobster, and ranges all the way from three thousand to ninety thousand. The maternal care which the female lobsters display for the young is small. The newly-hatched fry are entirely free, have no means of attachment, and are readily scattered by the tide and waves and become easy prey for the other marine animals. The eggs are combed from the female into a bag occupying the space between the two cabins on the house-boat, and after being hatched are transferred into the regular canvas bags with propellers. Here they are carried through the interval of two to three weeks. The chief difficulty in rearing fry through this period in any considerable numbers consists in so confining them that they will not die from the effects of suffocation, mechanical shock, starvation, cannibalism, or parasites. This is remedied effectively by keeping the water constantly stirred, and the lobsters and their food suspended in the water. The attack from parasites constitutes one of the most serious difficulties to contend with. Frequently the young lobsters are so completely covered with a growth of parasites, which hinders their movements, that it interferes with feeding and with moulting, so much so as to finally cause death. Of unusual interest is Dr. Mead's observations on the early life habits and appearance of the young lobsters, hitherto not generally known, during the four stages of their infancy. The huge white bag, swarming with millions of the tiny creatures, furnishes at all times a fascinating and kaleidoscopic picture of marine life. The best food so far discovered for the young fry is the soft part of clams, the bodies of which were cut out and chopped into fine pieces and then thrown into the bag. Their habit of cannibalism made the question of ample food supply an important one. The only way found to prevent them from destroying one another was to give them an abundance of food. In the process of latching, the first stage lasts about three days, the second about four or five, and the third five or six, though the length of each period varies greatly, depending upon the water temperature, the food supply, and the general health of the young fry. From nine to sixteen days are required for the larvæ to pass from the first to the fourth stage. The young, immediately after hatching, are designated as belonging to the "first stage"; after they have moulted once, as belonging to the "second stage," and so on. The surest and quickest means of distinguishing the different stages is by the appendages along the underside of the abdomen (tail). In the first stage there are none; in the second stage several pairs of swimmerets are present; in the third stage appendages appear upon the end segment of the tail. The fourth stage is so different from the preceding ones that no difficulty is ever experienced in distinguishing it.

During the first three stages the lobsters swim near the surface in an aimless, jerky way. They are entirely unfitted for a bottom life. The thorax bears five pairs of forked limbs, which ultimately become the walking limbs of the lobster. One branch of each leg—the lower—extends forward and downward, and is

used solely for feeding; the other, which is fringed with long hairs, bends upward to the side of the thorax, and by vigorous downward strokes helps to keep the larva afloat. The abdomen (tail) of these lobsters is bent downward at right angles to the body and is the chief swimming organ, and by means of rapid, irregular, downward strokes sends the animal tumbling over and over. When the lobster has nearly reached the surface, it often rests for a little, and sinks gradually toward the bottom.

The most marvelous and astonishing change of form and habits occurs at the third moult. The emerging fourth-stage lobster has the general form of the adult. The abdomen is no longer bent down, at right angles with the body, but now extends straight behind. The downward stroke of the abdomen, which was the chief means of motion during larval life, is now used, as in the adult, only for rapid retreat. All five pairs of walking legs have lost their upper branches, and the first pair, which are now the large, characteristic nippers, are extended straight in front of the head while the lobster is swimming. The other walking legs are relatively shorter than in the larvæ, and are fitted for walking. These structural changes are accompanied by more radical differences in habits and instincts. He is no longer helpless upon the bottom, but burrows under shells or stones for a home, crawls over the bottom or swims about in search of food, avoids enemies, and instantly retreats from danger when attacked. A new style of locomotion is adopted, and he swims forward in a straight and perfectly definite course by the strokes of the swimmerets. In the

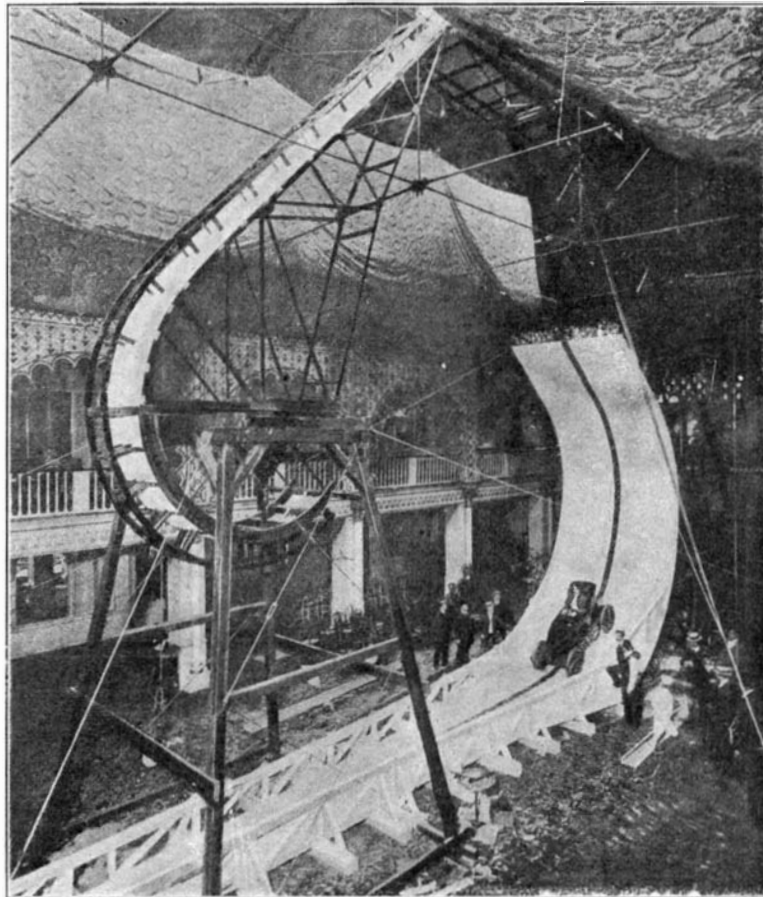

The Auto-bolide, on which an Automobile and Its Occupant Travel at the Rate of 130 Miles an Hour and Incidentally Turn a Complete Somersault in the Air.

fourth stage the lobster has passed the most crucial period of its entire life, and is vastly better fitted for the struggle for existence than in any earlier stage. After lobsters have been carried through to the fourth stage, they are liberated in lots of one to five thousand at various points. One of the most suitable methods adopted was to set them free in the morning upon a stony shore, when the tide was out. Here they could find a satisfactory place to burrow and hide from their enemies, also a chance to obtain food. If thrown overboard in large quantities in deep water at one place, they would undoubtedly attract large numbers of fishes and other enemies, and consequently be devoured. The hiding and burrowing habits which are taken up when the fourth stage is reached, continue to be characteristic of the lobster during the earlier period, and doubtless throughout life. In the cars where they are confined, the lobsters show a ready appreciation of anything which will serve as a hiding place, such as shells, stones, seaweed, etc. Aside from rearing the young fry up to the last stage, many new and important problems are being worked out, such as the rate of growth, age of maturity, regeneration, migration of adult lobsters along the coast, to and from deep water. These are copper-tagged with a number and request to return, when caught, to the hatchery. The record one for traveling up to date covered a distance of ten statute miles in less than eight days. By experiment it has also been proved that the young lobster could withstand the cold of winter and the freshened water of early spring. They were submerged in cars in November, and were sunk

in the channel in from eight to ten feet of water and left undisturbed until spring. No food was given them, although they may have obtained some from the water or from the animals which grew in the car. In the spring they were raised, and seemed not to have suffered from their long fast and winter's exposure. They were all in a healthy condition, but so torpid with the cold that they could be picked up with the hand, becoming very lively, however, when warmed. It was found that the size of the lobsters of the same age varied greatly, though reared in exact conditions. The immediate cause of these differences is probably due to the amount of food taken, as some are more courageous than others in foraging.

The Wickford hatchery, through the painstaking and scholarly researches of Dr. Mead, has conclusively proven that artificial lobster culture upon a large scale is now practicable; while the establishment of numerous hatching plants, liberating millions of young fry annually, is destined ultimately to reclaim the valuable waning lobster industry of this country. The author acknowledges his indebtedness to Dr. A. D. Mead for data incorporated in the foregoing sketch, and to Mr. Hadley for drawings reproduced of the newly-hatched "lobsterlings."

THE AUTO-BOLIDE.

The latest of those daring contrivances which seem to defy all dynamic laws, and for which Parisians in particular seem to have an overweening fondness, is the "Auto-Bolide"—compared with which "looping-the-loop," "the circle of death," and other felicitously-named "amusement" apparatus seem tamely commonplace. The accompanying illustration, which is reproduced from L'Illustration, shows the apparatus clearly enough, but the account which that paper gives of the principle upon which Mlle. de Tiers whirls around this structure, in a specially-constructed automobile, is anything but clear. We are simply vouchsafed the information that a platform is situated a considerable distance from the ground, from which platform two rails descend at an angle of 45 degrees, terminating in a sharp though graceful upward curve. Separated from the end of this curve by an air gap of some 30 feet is an ordinary loop-the-loop track. The entire contrivance resembles more the letter S than anything else. Indeed, at the Folies-Bergère this piece of acrobatic foolishness is called "la boucle en S."

From the very obscure description of Mlle. de Tiers' automobile, it would seem that the vehicle is provided with rollers which grip the track on the downward plunge, leaving it at the air gap, and allowing the automobile to finish the last stretch of this hazardous course on its own wheels. Since the occupant of the vehicle must turn a complete somersault in the air, a heavy counterweight is secured to the front part of the machine, to assist it in its revolution. The leap across the gap is said to be "impressive." Startling, would be a more fitting description. The tires receive a violent shock, but seem to stand it well enough. The entire distance of 50 meters (164 feet) is covered in four seconds, or at a speed of about 130 miles an hour. It may be a matter of rejoicing to engineers to know that not a member of their profession is the inventor of this absurdity, but a painter, M. Alonzo Perez by name.

Fiala Rescue Expedition Fails.

W. S. Champ, leader of the expedition that started to relieve Ziegler's North Pole expedition under Anthony Fiala, telegraphs as follows:

"I regret to report my failure to reach Franz Joseph Land. The ice is insurmountable. The approaching winter and heavy frost have compelled me to abandon further effort."

Fiala left New York in May, 1903, for Norway, where his ship, the "America," was waiting. His plan was to go to Camp Ziegler, Alger Island, for winter quarters, and in the spring of this year to make the dash for the pole.

A notable locomotive engineer, Mr. William Adams, M.I.C.E., has recently passed away in his eighty-first year at Putney, England. He was one of those most closely associated with the development of the present type of locomotive, and was the first to produce an engine especially adapted for short-distance traffic. This engine, which was designed in 1868 for stopping and starting with great acceleration, has served as a model for this class of work ever since. During the course of his brilliant career Mr. Adams was the locomotive engineer for three of the most prominent trunk railroads in Great Britain.

SPELTERINI'S EGYPTIAN PICTURES.

Among the means employed for obtaining bird's-eye views of elevated objects are kites and balloons. Cameras have been sent up on the strings of powerful kites and so arranged that the sensitive plate contained therein could be exposed to the reflection of the picture below. No mean results have been thus obtained, yet this scheme serves only in the absence of the more exhilarating medium, the balloon ascension. What is thus obtained can never approach a view taken where, instead of depending upon a favorable puff of wind, the mind of the operator directs the lens from the basket of a balloon. Such a picture we take pleasure in reproducing here from the *Illustrierte Aeronautische Mitteilungen*. It is one of several views of the vicinity taken by Mr. Ed. Spelterini on February 21, 1904. Our photograph fails to reproduce all the luxuriance of color, all the sensations engendered by this prospect under an African sky.

From the height, which must have reached several thousands of feet, we clearly see the canal of Jusuf, which is at times a dry bed, but just now is apparently filled with the life-giving fluid so bountifully dispensed by Father Nile; again, in the distance, is equally clearly discerned the 8-mile straight-away, tree-bordered drive from the town of Ghizeh to the Mena House situated almost at the very foot of the great Pyramid.

The Living Crystal.

The researches of Dr. Otto von Schrön, Prof. of Pathological Anatomy in the University of Naples, says a writer in *Knowledge and Scientific News*, gave meaning some ten years ago to the expression "the living crystal." He showed that living matter, largely albuminous in character, takes the crystalline form, and, while still living and crystalline, obeys so many of the laws and manifests so many of the prop-

erties of inorganic crystallization, that its crystalline character may be said to be established. From these experiments he drew the inference that crystallization in its terrestrial origin was a manifestation of life—of vital energy; in short, that a crystal grew for the same reasons that a plant grows, or the brain grows, or an amoeba grows; that the vital forces stirring the one are no more than a different form of the forces that develop the other. The "living crystal," the "vital crystal" which, for example, he discovered as one of the products evolved by various of the bacilli that he examined, became thus, in his theory, the bridge between what had heretofore been called living matter—animal and vegetable—and dead matter—mineral. The first crystals which set him on the road to this theory were the crystals of the Asiatic cholera bacillus, which he examined as long ago as 1886. They were long, needle-shaped prisms. Other bacilli examined exhib-

ited distinct crystals of different forms. The *bacillus subtilis*, for instance, formed bayonet rhombs; the *bacillus tenuiformis*, hexagonal prisms; the tubercle bacillus develops square rhombs; anthrax, elongated rhombs; any given bacillus being immediately identified by its crystal, which never varies in the shape assumed in its original formation. These objects are perfect crystals in form; yet, as anyone may see, they are alive, and their life, their motion, and their reproduction are as visible and undoubted as their death when it ensues is undoubted. Their death occurs when all the living matter which originally formed part of the crystal has eliminated itself. On death they become the crystals that we know, ordinary mineral crystals.

Scrap leather is the latest substitute for wood in the manufacture of railroad ties. This process has been worked out by F. W. Dunnell, of West Warren, Mass., who has had occasion to give the subject of paper making some study, and the leather railroad tie is the result. He claims that the tie can be made so hard that it will resist a spike, if this were desirable; but when the tie is made at a proper density for railroad purposes, it will take the spike as nicely as wood, and will hold it much better. The tie is said to resist the action of water and chemicals to a great extent, and the inventor estimates its life at thirty-five years.

Samples of this tie put down some twenty-eight months ago in the yard or the Boston & Albany Railroad at West Springfield have not shown the least wear, although they have been subjected to the hardest usage. The material from which these ties are made represents the waste of the shoe and leather goods factories, of which there are many in New England.

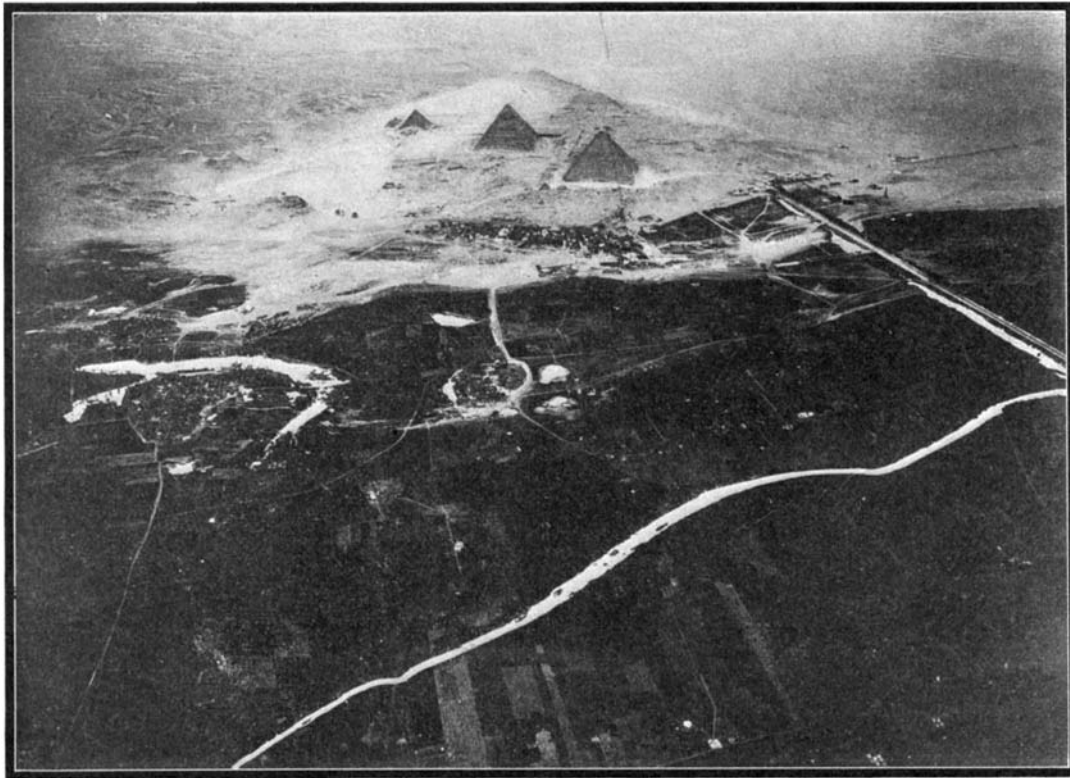

BIRD'S-EYE PHOTOGRAPH OF THE EGYPTIAN PYRAMIDS TAKEN FROM A BALLOON.

RECENTLY PATENTED INVENTIONS.

Of General Interest.

MARINE HULL.—T. H. SMITH, Sturgeon Bay, Wis. In this case the invention consists in an improved manner of constructing metallic hulls, and it lies particularly in the means for fastening the metallic sheathing to the frame, in the manner of joining the sheathing-plates to each other, and in the novel means for stiffening the entire structure.

MEN'S NECKWEAR.—J. H. STARK, New York, N. Y. The invention refers particularly to improvements in neckwear or scarfs of the class having an apron or aprons depending from a collar-engaging device, an object being to so construct the parts that the apron may be readily rotated around a vertical axis relatively to the head or collar engaging device to present new or different surfaces, thus practically providing two scarfs in one.

PACKAGE-CAN.—M. SHALITA and P. SHALITA, New York, N. Y. In this patent the invention has reference to the construction of cans preferably made of metal and adapted especially for liquid contents, the cans being of that type in which a removable cover is employed, held in place by frictional engagement with the mouth-section of the body of the can.

BUILDING-BLOCK.—G. GERARDTS, New York, N. Y. The invention relates to masonry; and its object is the provision of a new and improved block for forming partition-walls and the like, arranged to permit easy and quick setting of the blocks and a firm uniting of adjacent blocks to produce an exceedingly strong, durable, and light wall.

EYEGLASSES.—H. MASTERS, Butte, Mont. Mr. Masters in this instance has invented an improvement in eyeglasses, and particularly in glasses involving double lenses or two pair of lenses. Bow-clamps clamp directly upon the lenses, and are slightly outturned at their free ends, forming rounded surfaces against the lenses, so they can be applied tightly to the lenses without injuring the latter.

TOBACCO-PIPE.—R. S. KOCH, Bethlehem, Pa. The principal object in this improvement is to provide means for absorbing and retaining moisture and preventing it from interfering with the draft. Moisture collecting in the stem is a very disagreeable feature, and many attempts have been made to do away with it, but the inventor is not aware any have been practically successful. The chief aim is to accomplish this object.

DOUBLE RETURN-ENVELOP.—J. Q. DIXON, St. Louis, Mo. Mr. Dixon's invention is an improvement in that class of envelopes known as "double" or "return" envelopes and

which are constructed of a single blank adapted to be folded, one portion being adapted to be folded within the other and serving as the return-envelop proper when the outer portion is detached by the addressee.

EASEL-SUPPORT FOR DISPLAY-BOXES.—C. W. DE LANEY, Hammond, Ind. The object here is to provide details of construction for a device which affords a reliable support for a display-box that may be readily attached thereto, so as to maintain the box in an upwardly and rearwardly inclined position for an exhibition of goods held in the box and also a conspicuous display of advertising matter placed on the box and easel-support.

CLAMP FOR WELDING TIRES.—C. S. BEAKER, Worth, Mo. In this patent the improvement has reference to clamps for use in heating and welding tires; and its principal objects are to provide such a device for holding the ends of tires in their proper relation for making a lap-weld, thus enabling the smith to dispense with a helper's services.

SHOWER-RING.—W. H. LAWRENCE, Worcester, Mass. This invention pertains to bathing apparatus; and its object is the provision of a new and improved shower-ring arranged to permit the bather to readily place the ring in position on the neck and remove it therefrom whenever it is desired to do so.

ATTACHMENT FOR SURVEYING INSTRUMENTS.—E. R. ARMSTRONG, Beaumont, Texas. There are several objects of Mr. Armstrong's invention, which relates to surveying and other instruments of a kindred character in which a telescope is used to aid in measuring distances and angles; but the principal object is to provide for reading all data directly from the instrument, and thus avoid all the ordinary calculations, which usually have to be made at night after fieldwork is rendered impossible by darkness.

Heating and Lighting.

APPARATUS FOR AUTOMATICALLY LIGHTING OR EXTINGUISHING STREET OR OTHER GAS-LAMPS.—J. BERGAN, Granville, New South Wales, Australia. The object of this invention is to provide an apparatus for lighting and extinguishing the street-lamps throughout an entire district or city by means of a device actuated from one central station or from district central stations, and consequently without the necessity of daily attention on the part of a lamplighter.

Machines and Mechanical Devices.

SCENE-SHIFTING MECHANISM.—H. S. THOMAS, New York, N. Y. In this patent the

invention has reference to improvements in mechanism for shifting scenic curtains, an object being to provide a simple mechanism arranged in a comparatively small space, whereby a plurality of screens may be raised and lowered, one independently of another, to produce varying effects or illusions or to display suitable backgrounds.

REVERSIBLE FEED MECHANISM FOR SEWING MACHINES.—W. A. SMITH, New York, N. Y. The invention relates to improvements in reversible feed mechanisms for sewing-machines of the class disclosed in a prior patent granted to Mr. Smith; and one object of the present invention is the provision of a device for releasing and moving endwise the controlling or adjusting bar by a simple turn of the device in one direction or the other. Simple means release the adjusting-bar without moving it endwise, and the inventor provides an improved form of feed-dog, throat-plate, and bridge on the bed-plate.

BAND-SAW.—C. SEYMOUR, Defiance, Ohio. The object of this inventor is to provide a saw arranged to permit convenient and accurate adjustment of the feed-table for making straight and beveled cuts, to allow the feed mechanism to automatically accommodate itself to inequalities in the work, to insure proper guiding of the work past the saw-band, and to take up any slack in the endless saw-band, and to allow the latter to slightly yield under heavy strain, and to permit the operator to stop the feed instantly when desired.

SUPPLY-TANK FOR WATER SERVICE.—P. J. LEITHAUSER, Clarendon, Texas. The water service of an establishment frequently includes a supply-tank at a proper elevation to derive the desired head or fall of water, it being usually pumped into the tank as required. However, the tank may be constructed entirely open at the top so that rainfalls supply the tank without use of a pump, and for reasons of economy and strength it is not uncommon to construct it of wooden staves held together by encircling metal bands. Under certain conditions the sides above the water become so dry as to cause the staves to shrink, warp, and produce leakages. The inventor's principal object is to overcome this objection.

CONTROLLER FOR SPRING-ACTUATED GEAR WHEELS.—A. HILLGREN, New York, N. Y. In this case the object is to provide means for causing the train to evenly deliver the ever-changing power imparted thereto by the uncoiling force of the mainspring to insure a uniform running of the train or gear-wheels driven from the spring-barrel, so that in watches, for instance, the balance-wheel will vibrate uniformly.

SINGLE-TRIGGER FIREARM.—H. E. WIXMANS, Poughkeepsie, N. Y. This arm is intended to be a practical and successful device that will fulfill two important requirements—first, freedom from a tendency to discharge both barrels in rapid succession by an involuntary pull on the trigger, and, secondly, the ability of the user to select at will the right or left barrel for service.

METALLIC PACKING.—J. J. REDNER, New York, N. Y. This packing is intended for use on steam-pistons and similar purposes. The packings now on the market answer their purpose in a general way, but those having a lock to prevent them from turning on the piston or other element to which they may be applied, are so constructed that they sometimes become caught on one side or in contracted position, thereby permitting steam to escape. The inventor remedies these defects by providing a lip-lock packing-ring which cannot get caught.

LUBRICATOR.—A. G. PUERNER, Stoughton, Wis. The invention relates to lubricators, particularly those adapted for application to windmills and the like. In apparatus of this class on account of its comparative inaccessibility it is of importance to provide them with a device which will from a common reservoir positively deliver the lubricant to the frictional surfaces of the mill in cold and warm weather, this supply being furnished in varying measured quantities to different elements. The objects are to achieve such results.

CAR-BRAKE.—H. HOFFMANN, New Rochelle, N. Y. The purpose in this instance is to provide a construction of brake which will be quick in action, and under perfect control of the motorman or attendant even should the strength of the attendant be below normal. The inventor dispenses with the winding of brake-chains directly on brake-shafts and provides a brake construction which will be economic and readily adapted to any type of rolling-stock.

STUB-SWITCH FOR RAILWAYS.—J. G. MCKEOWN, Phoenix, Canada. This invention has reference more especially to stub-switches; and one of the principal objects thereof is to overcome numerous disadvantages frequently met in the use of many devices of the kind and also to provide a railway-switch which is thoroughly effective and reliable in operation and comparatively inexpensive to manufacture. It comprises few parts, is easily regulated and possesses the capacity for long and repeated service.

NOTE.—Copies of any of these patents will be furnished by Munn & Co. for ten cents each. Please state the name of the patentee, title of the invention, and date of this paper.

Get out of the old ruts !!

DECREASE the cost of your truckage
 WHILE YOU
INCREASE the speed and capacity of your teams

The Steel Highway Track

Just what is needed for Factories, Coal and Lumber Yards, Breweries, Plantations, etc., to facilitate handling of Products at minimum expense.

Get prices and particulars.

Ask for booklet "A."

Our Steel Highway Track has Steel Base-plates, Rail Supports, Tie-bars and Wedge Keys; no wood, no bolts, no burrs—but all metal, interlocking and indestructible.

This cut shows the track as laid; the cut below shows construction in detail.

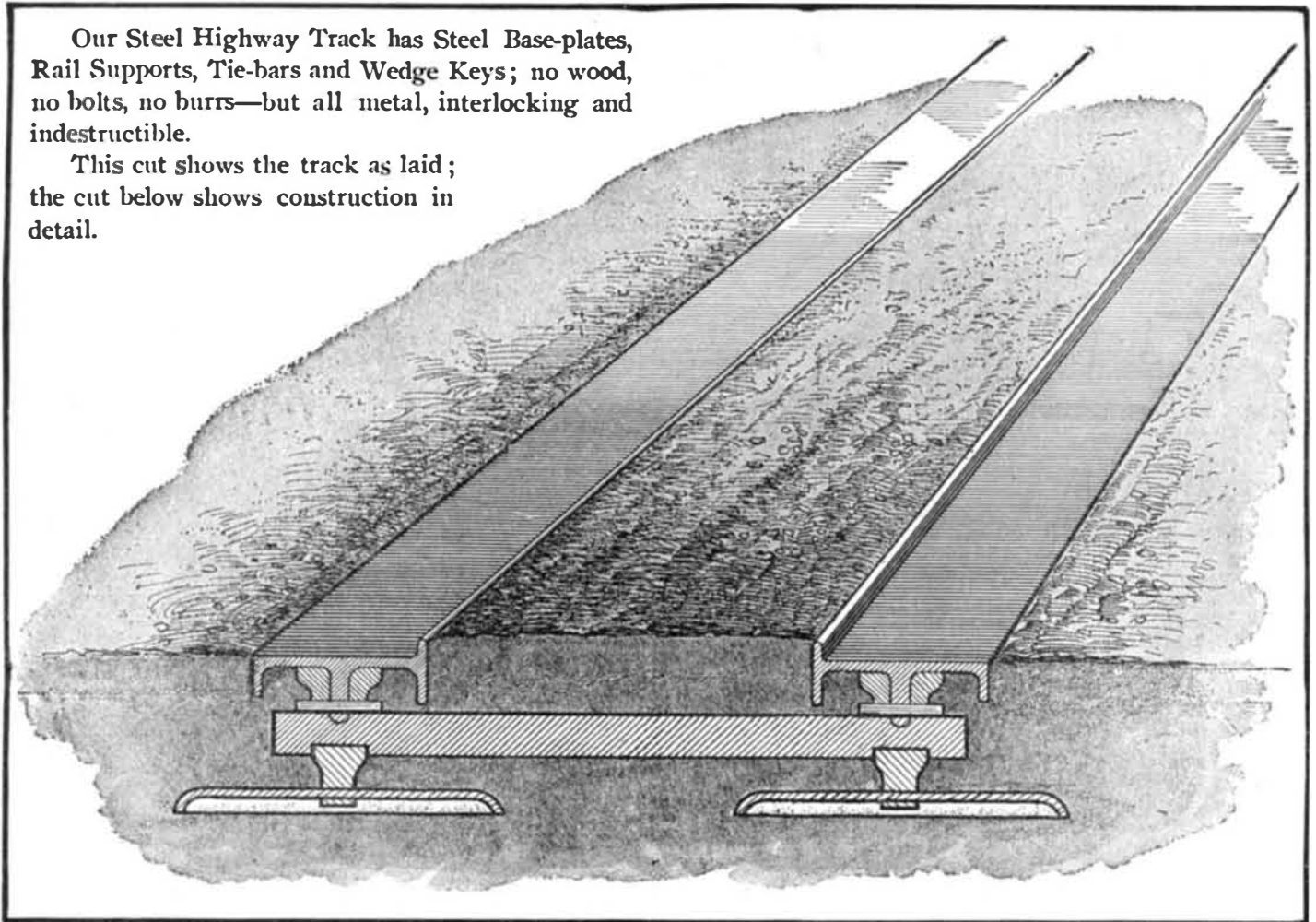

One horse on a Steel Highway Track can pull as heavy a load as six horses on a good macadam road, or twelve horses on a good gravel road

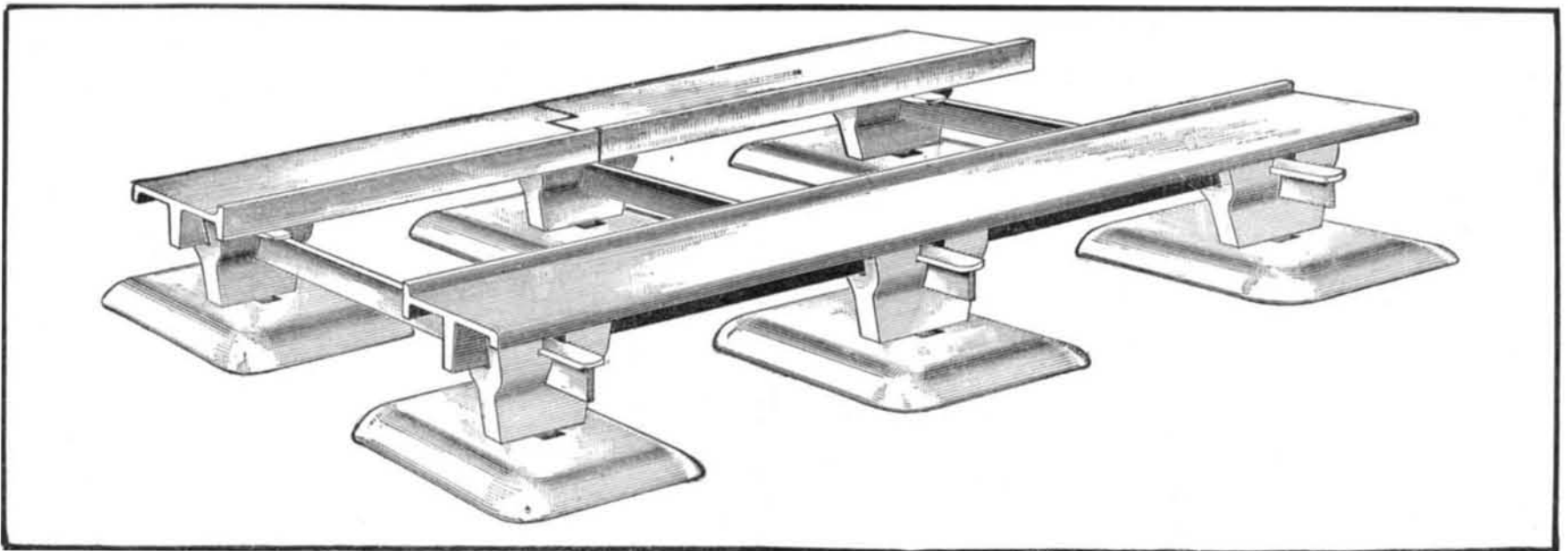

Correspondence solicited relative to the formation of subsidiary companies operating State rights

Steel Highway Track Construction Co.
 OF AMERICA

Let us put you on the Right Track!

MAIN OFFICE:
 758 Drexel Building
 Philadelphia

Business and Personal Wants.

READ THIS COLUMN CAREFULLY.—You will find inquiries for certain classes of articles numbered in consecutive order. If you manufacture these goods write us at once and we will send you the name and address of the party desiring the information. In every case it is necessary to give the number of the inquiry.

MUNN & CO.

Marine Iron Works. Chicago. Catalogue free.

Inquiry No. 6021.—For makers of worms for corkscrews.

AUTOS.—Duryea Power Co., Reading, Pa.

Inquiry No. 6025.—For makers of small dies (cubes) suitable for parlor games.

For mining engines. J. S. Mundy, Newark, N. J.

Inquiry No. 6026.—For manufacturers of wool-knitting machines.

"U. S." Metal Polish. Indianapolis. Samples free.

Inquiry No. 6027.—For makers of toy looking-glasses.

Perforated Metals. Harrington & King Perforating Co., Chicago.

Inquiry No. 6028.—For a storage battery which does not freeze, and is not liable to damage from jolting in a railway coach.

Handle & Spoke Mch. Ober Mfg. Co., 10 Bell St., Chargin Falls, O.

Inquiry No. 6029.—For manufacturers of the pith of corn stalks.

If it is a paper tube we can supply it. Textile Tube Company, Fall River, Mass.

Inquiry No. 6030.—For a machine for stamping wooden rules, yard sticks, etc.

Sawmill machinery and outfits manufactured by the Lane Mfg. Co., Box 13, Montpelier, Vt.

Inquiry No. 6031.—For manufacturers of bottle-cleaning machines.

D. A. Beaton, Practical Lead Burner, P. O. Box 334 Woburn, Mass. Fifteen years' experience.

Inquiry No. 6032.—For makers of gutta-percha, or "rod gutta."

WANTED.—Three first-class tool makers, ten good machinists. Western Motor Co., Logansport, Ind.

Inquiry No. 6033.—For manufacturers of butter and cheese making machinery.

American inventions negotiated in Europe. Wenzel & Hamburger, Equitable Building, Berlin, Germany.

Inquiry No. 6034.—For manufacturers of heavy trucks and motor omnibuses.

Patented inventions of brass, bronze, composition or aluminum construction placed on market. Write to American Brass Foundry Co., Hyde Park, Mass.

Inquiry No. 6035.—For makers of small carbon bulbs, 1-16 inch diameter and less, for electric transmitter. The bulbs to be polished.

Send for new and complete catalogue of Scientific and other Books for sale by Munn & Co., 361 Broadway New York. Free on application.

Inquiry No. 6036.—For dealers in advertising novelties.

Any metal, sheet, band, rod, bar, wire; cut, bent, crimped, punched, stamped, shaped, embossed, lettered. Dies made. Metal Stamping Co., Niagara Falls, N. Y.

Inquiry No. 6037.—For a cremating furnace for stable manure, street sweepings, etc.

Manufacturers of patent articles, dies, metal stamping, screw machine work, hardware specialties, machinery and tools. Quadriga Manufacturing Company, 18 South Canal Street, Chicago.

Inquiry No. 6038.—For manufacturers of gasoline motor cylinders with auxiliary exhaust.

Two patents for sale. Supply tanks for water service, No. 709,550. Valve, a cut-off, for supply tanks, No. 737,941. Can furnish some valves, cut-off, in working order. P. J. Leithausner, Clarendon, Texas.

Inquiry No. 6039.—For dealers in stage scenery.

English and European Market for American Manufacturers.—W. & R. Leggett, Limited, East Parade, Bradford, England, is in remarkably good position for handling any article connected with building trade, and will be glad to act as agent for American firms. Please communicate.

Inquiry No. 6040.—For manufacturers of the Plato clock.

The celebrated "Hornsby-Akroyd" Patent Safety Oil Engine is built by the De La Vergne Machine Company Foot of East 13th Street, New York.

Inquiry No. 6041.—For makers of small metal postage stamp boxes.

Partner with means of a well-known firm on the Pacific Coast, well experienced and acquainted, open for engagement, or shortly, would like to handle a good article for a well established firm. Best of references. L. Folkers, 931 Filbert Street, Oakland, Cal.

Inquiry No. 6042.—For makers of novelties in toys and games.

Inquiry No. 6043.—For manufacturers of sand and emery paper.

INDEX OF INVENTIONS

For which Letters Patent of the United States were Issued for the Week Ending September 20, 1904 AND EACH BEARING THAT DATE

[See note at end of list about copies of these patents.]

Table listing inventions with patent numbers and names of inventors. Includes items like 'Account registering system', 'Addressing machine', 'Advertising apparatus', etc.

Main table listing inventions with patent numbers and names of inventors. Includes items like 'Block molding press', 'Boiler press', 'Boiler furnace', 'Boiler stand', 'Boiler stay bolt', etc.

'Star' Lathes advertisement featuring an image of a lathe and text: 'FOR FINE, ACCURATE WORK. SENeca FALLS MFG. CO. 695 Water Street, Seneca Falls, N.Y., U.S.A.'

'ENGINE & FOOT MACHINE SHOP' advertisement for 'LATHES TOOLS & SUPPLIES' by SEBASTIAN LATHE CO. CINCINNATI, O.

'TAKE THE NICKEL PLATE ROAD FOR THE ST. LOUIS FAIR.' advertisement for 'VEEDER COUNTERS'.

'VEEDER COUNTERS' advertisement with an image of a counter showing '99728' and text: 'to register reciprocating movements or revolutions. Cut full size. Booklet Free. VEEDER MFG. CO. Hartford, Conn.'

'KENT POCKET METERS' advertisement for 'Automatic Volt-Ammeter' with an image of a meter and text: 'Is designed and calibrated especially for testing batteries on gas oil engine automobiles and launchers and for any other use of like capacity. Amperes reading made simply by pressing button. The most convenient and complete battery tester on the market.'

'Complete Electric Lighting Plant' advertisement with an image of a lamp and text: 'Price, \$34.00. Dynamo only, for 16-c.p. lamps, \$20.00; lamps, wire, fixtures, etc., \$8.00; just suitable for residences, small factories, yachts, etc.'

'THE CLIPPER CLIP' advertisement with an image of a clipper and text: 'Its triangular shape prevents crumpling and gives three times the capacity of any other clip for attaching papers together. Best & Cheapest. All Stationers. CLIPPER MFG. CO., 401 West 124th St., New York, U.S.A.'

'THE HARRINGTON & KING PERFORATING CO.' advertisement for 'PERFORATED METALS OF EVERY DESCRIPTION FOR ALL USES. SCREENS OF ALL KINDS. 225 NORTH UNION ST. CHICAGO, ILL.'

'Eclipse Pocket Ammeter' advertisement with an image of an ammeter and text: 'For general battery testing. 0 to 30 amperes. Flexible cord attached and contact spur in case, which is drawn back into case, when carried in pocket. Size of watch and very light weight. Can be used in any position. Particularly designed for Auto. use. Price \$5.00. ELDRIDGE ELECTRIC MFG. CO., 227 Main St., Springfield, Mass.'

'A GOOD INVESTMENT' advertisement with an image of a press and text: 'For \$1.75 we will send by express (not prepaid), complete N. D. outfit with full instructions for learning TELEGRAPH OPERATING. A fascinating study that will enable you to earn good wages. Send for our catalog. Established 1879. J. H. BUNNELL & Co., Inc. 20 Park Place New York'

'Presses for Sub-Press Work' advertisement with an image of a press and text: 'Five sizes. Sub-Presses and Tools to order. Send for Catalogue. BLAKE & JOHNSON, P. O. Box 7, WATERBURY, CONN.'

'BARKER MOTORS' advertisement with an image of a motor and text: 'Have more good points, fewer parts and require less attention in operation than any other. Launches, Valves, Specialties. C. L. Barker, Norwalk, Ct.'

'Induction Coils' advertisement with an image of a coil and text: 'for X-Ray Apparatus and Wireless Telegraphy. Special Jump Spark Coil for Automobiles and Gas Engines. E. S. RITCHIE & SONS, Brookline, Mass.'

'Yankee Spark Plug, \$2 FOR GAS ENGINES' advertisement with an image of a spark plug and text: 'Cannot carbonize or short circuit. Compression end cleans point at each explosion. Guaranteed. Everything for the Automobile, Bicycle and Motor Boat. Big Free Catalogue. E. J. WILLIS CO., 2 Park Place, New York'

Table listing inventions with patent numbers and names of inventors. Includes items like 'Grain drills, cultivators, or like implements', 'Grain separator', 'Grate, fireplace', 'Grip, for exercising purposes', etc.

Gaeger WOOLENS

For its many thousands of patrons Jaeger Underwear needs no recommendation. They know its worth because they enjoy its benefits. From others we simply invite a trial, confident that they too will promptly acknowledge its merits. No underwear like it for Health and Comfort both.

SPECIAL WEIGHTS FOR FALL
Booklets and Samples Free.

DR. JAEGER'S S. W. S. CO.'S OWN STORES:

New York: 306 Fifth Ave.
157 Broadway
Brooklyn: 504 Fulton St.
Boston: 230-232 Boylston St.
Phila.: 1510 Chestnut St.
Chicago: 82 State St.

Agents in all
Principal
Cities.

Railway safety signal device, B. Etienne... 770,569
Railway sleeper construction, H. Bywater... 770,349
Railway switch, etc., R. S. St. George-Moore... 770,614
Railway switch and interlocking apparatus, C. J. Coleman... 770,265
Railway tie, Nelson & Nicholls... 770,604
Railway tie, J. A. Markil... 770,690
Railway tie, composite, J. J. Luck... 770,469
Railway tie, metallic, W. E. Burgess... 770,259
Railway truck structure, W. Wharton, Jr... 770,210
Railway vehicle, G. Gibbs, reissue... 770,268
Rake, P. A. Letendre... 770,594
Red lake, Herzberg & Siebert... 770,430
Resistance bar, R. Scott... 770,600
Reversing mechanism, F. C. Mudd... 770,602
Rheostat, J. Nelson... 770,472
Rotary motor, N. W. Fletcher... 770,522
Rotary motor, L. S. Craddock... 770,712
Roving guide traverse motion, L. Owen... 770,440
Running gear, A. F. Madden... 770,725 to 770,727
Safety pin, H. A. Norton... 770,304
Sausage machine, A. Heintze... 770,378
Sawmill set, W. G. Brown... 770,317
Saw set, Hawkins & Perry... 770,429
Scaffold bracket, F. Haas... 770,685
Scale, weighing and computing, T. A. Killman... 770,294
Scarf pins, studs, etc., safety device for, A. Landau... 770,592
Scraper, S. Meeker... 770,647
Screen bin, portable, D. B. Cook... 770,353
Seal for screw nuts, etc., E. J. Brooks... 770,257
Secondary battery, L. Fiedler... 770,277
Sewage, purifying, J. W. Alvord... 770,399
Sewer pipe and coupling, Phelan & Billings... 770,383
Sewing machine attachment holder, L. P. Zimmer... 770,707
Sewing machine feed mechanism, J. H. & J. B. Ursbruck... 770,447
Sewing machine guide, fur or carpet, C. H. Cunningham... 770,678
Sewing machine thread controller, E. L. Bowers... 770,516
Shade, adjustable window, B. F. Childress... 770,262
Shade fixture, T. Sulikx... 770,511
Shade fixture, window, Attebery & Giles... 770,252
Shoers, J. H. Brown... 770,347
Shoers, E. Blasberg... 770,551
Shirt, L. Stern... 770,331
Shirt, J. Engel... 770,714
Shoe fastener, E. Phillips... 770,535
Shoe form treering machine, W. L. C. Niles... 770,473
Sign, illuminated, W. C. De Camps... 770,680
Signal spectacle frame, R. Herman... 770,462
Skirt raiser, dress, L. Schlichter... 770,702
Skylight or transom lifter, K. Rodelstap... 770,316
Snatch block, Walters & Prichard... 770,514
Soda tank coupling head, C. Geddies... 770,570
Sole and heel setting, trimming and burnishing machine, boot or shoe, Z. Beaudry... 770,415
Spanner or wrench, Halstead & Chandler... 770,574
Spark arrester, J. G. Gullick... 770,638
Spice box, W. West... 770,485
Spindles, bobbin clutching means for rotatable, F. H. Thompson... 770,402
Spoke puller, A. K. Olson... 770,474
Spraying apparatus, F. A. Perkins... 770,506
Stacker, hay, E. & H. Turnell... 770,339
Stacker, straw, J. G. Randall... 770,349
Stair pad making machine, H. T. Baker... 770,348
Staple setting device, F. P. Nourse... 770,693
Steam dome and breeching, C. A. Huffmaster... 770,405
Steering device, W. H. Douglas... 770,567
Stereoscope, Wagner & Cotton... 770,705
Stone, composition of matter for artificial, C. W. Brunson... 770,557
Stone sawing machine, C. A. Thomson... 770,403
Stone working tool, A. E. Douglas... 770,455
Stones, coloring natural crystalline, E. Klie... 770,643
Stopping device, W. R. Green... 770,281
Stove, gas, R. Sturges... 770,615
Stovepipe ventilator attachment, T. J. Stafford... 770,329
Sugar from beets, making, Roessler & Schaer... 770,700
Sun dial, E. G. Hewitt... 770,580
Surgical instrument, A. C. Heath... 770,368
Suspenders, R. T. Clarke... 770,419
Switch. See Railway switch.
Switch, W. L. O'Brien... 770,305
Switch, G. E. Lemmon... 770,686
Switch mechanism, electromechanical, Duffy & Irwin... 770,456
Syringe, vaginal, H. Carstens... 770,452
Tackle block, H. L. Ferris... 770,520
Telegraphic key, interchangeable, W. C. Dean... 770,628
Telegraphy or transmission through space, A. Artom... 770,668
Telephone exchange system, W. M. Davis... 770,269
Telephone, single wire selective signaling and intercommunicating, J. A. Brown... 770,556
Telephone switchboard switch or ringing key, L. M. Ericsson... 770,424
Telephone toll apparatus, register and alarm, mechanism for, G. A. Long... 770,377
Telephone transmitters, detachable and antiseptic, mouthpiece for, C. D. Wright... 770,410
Telephonic relay, I. Kitzee... 770,296
Telescoping mechanism, H. E. Bayly... 770,550
Thermal inductor, T. B. Kinraide... 770,433
Thermometer, Wurm & Baumann... 770,345
Ticket or check delivering machine, W. H. Champlin... 770,558
Tile making apparatus, Jaeger... 770,596
Tire, detachable pneumatic, C. S. Scott... 770,611
Tire, vehicle wheel, C. Burnett... 770,348
Tongue construction, vehicle, Geddes & O'Brien... 770,718
Tool, combination, W. H. McLeod... 770,380
Tool handle, detachable, W. Ashert... 770,113
Tool holder, J. Hunter, reissue... 12,269
Toy, E. A. Reineman... 770,386
Toy cash register, W. L. Dunham... 770,423
Toy, spirometer, H. G. Gady... 770,494
Trap, H. H. Holmes... 770,640
Tray or table, self-tilting, Harvey & Bruce... 770,297
Tread protector, L. B. Haggerty... 770,491
Truck, J. E. Kelly... 770,527
Truck, barrel, S. B. Mansfield... 770,436
Truck, hand, Cox & Forbes... 770,355
Tube cleaner, G. C. Quasbarth... 770,313
Tuck marking attachment, S. A. Swart... 770,481
Type casting machine type ejecting device, Mayer & Albrecht... 770,508
Type machine mold dimensioning mechanism, J. S. Bancroft... 770,253
Typewriting machine, W. W. Torrence... 770,605
Typewriting machine platen shift mechanism, G. M. Kitzmiller... 770,434
Umbrella frame joint, G. B. Vogel... 770,704
Undergarment, L. H. Seitz... 770,394
Valve, C. L. Scoville... 770,703
Valve, automatic release, N. R. Maus... 770,646
Valve, engine, J. B. Alifree... 770,671
Valve, flushing, T. C. Beaumont... 770,416
Valve for leach tanks, A. A. Stewart... 770,332
Valve gear, P. Dietz... 770,564
Vehicle, M. L. Sanderling... 770,445
Vehicle brake, motor, C. Schmidt... 770,392
Vehicle, pneumatic tire, C. Mercader... 770,531
Vehicle running gear, A. F. Madden... 770,728
Vehicle speed controller, motor, J. L. Fitz Gerald... 770,521
Vending machine, C. A. Gunder... 770,719
Vest, J. Engel... 770,715
Voting machine, N. B. Ross... 770,318
Wagon, dumping, C. G. Strelch... 770,335
Walks, stairways, etc., approach to movable, G. F. Cahill... 770,260
Wall structure, G. B. Waite... 770,616
Washing machine, T. M. Kirkwood... 770,295
Washing machine, J. S. Ruth... 770,391
Washing machine, E. Wilhelm... 770,706
Water heating, D. Cochran... 770,264
Water heating apparatus, A. P. Broomell... 770,627
Water motor, J. P. Shevlin... 770,324
Water raising or forcing apparatus, compressed air operated, E. Gaucher... 770,279
Water tube boiler, J. P. Sneddon... 770,664
Weather strip, W. Steger... 770,330
Weather strip, C. M. Rhodes... 770,444
Web interlacing machine, A. E. Sexton... 770,508
Weighing apparatus, liquid, C. Cooper... 770,876
Wheel block, H. P. Stullken... 770,510
Wind wheel, C. H. Smith... 770,327
Window cleaner, F. H. Curtis... 770,453
Window opening or shutting appliance, K. Rodelstap... 770,315

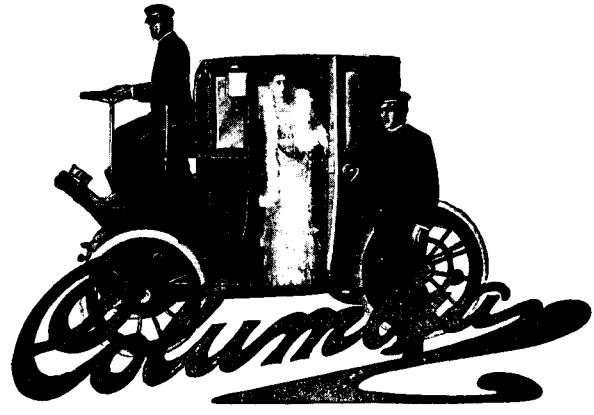

Many social leaders in New York and other large cities—people who demand and have the best of everything—are users of COLUMBIA Electric Broughams, Landaus, Landaullets, Hansoms, Coupes, Victoria-Phaetons and Opera Busses. These vehicles are built from exclusive designs and are sold for private service only. Let us send you a handsomely printed list of prominent purchasers and our special Town Carriage Catalogue.

ELECTRIC VEHICLE CO., Hartford, Conn.

NEW YORK, 134-138 W. 39th St. CHICAGO, 1413 Michigan Ave. BOSTON, 74 Stanhope St.

Member Association Licensed Automobile Manufacturers.

HAYNES 3 SPEED Tonneau 1 LEVER

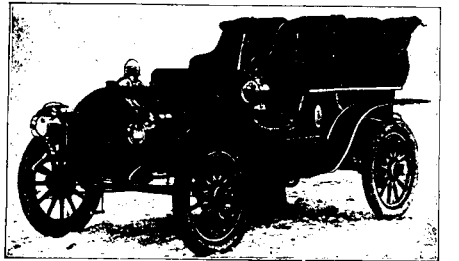

EFFICIENCY

in its highest degree can be obtained only through the employment of that which enables the automobilist to take advantage of existing conditions.

The Haynes 3 Speed 1 Lever Control Meets Every Road Condition

1st gear for starting and mountain climbing.
2d gear for hills, sand and bad roads.
3d gear for good roads and moderate grades.

RESULT: Never less than 80 per cent. efficiency of motor. All obtained by one lever. The catalog tells why. Write for it to-day.

THE HAYNES-APPERSON CO. Kokomo, Ind., U. S. A.

Member of the Association of Licensed Automobile Manufacturers.
Branches: New York, 1713 Broadway. Chicago, 1420 Michigan Avenue. Agencies in principal cities.

SPECIAL SALE

Finest Collection of VIOLINS in America

Nearly one thousand fine instruments are now being offered at a special sale. Every violinist and every violin student should write for the list. A genuine bargain in a fine violin may be obtained from this collection.

Write for List to

LYON & HEALY
49 Adams Street, Chicago

MAGIC LANTERNS and Stereopticons

QUALITY HIGH PRICES LOW

Supplied with Oxy-Hydrogen, Acetylene or Electric Burners. Complete Illustrated Catalogue supplied on application. Address

JAS. H. SMITH & CO., 350 Wabash Ave., Chicago, Ill.

We Removed Six Barrows of Scale

from two small boilers thought clean by the Petersburg Electric Light Plant of Petersburg, Ill., by means of

The Dean Boiler Tube Cleaner



Whatever your present tube cleaning methods are, we can save you hundreds of dollars—accept a free thirty days' trial.

THE WM. B. PIERCE CO.

319 Washington Street, Buffalo, N. Y.

None But Our Own Heads

Can get within polishing distance of this little machine. The Polishing Head is fitted with a three-jawed chuck, holding up to 1/4 inch. This extra recomendatory feature will be appreciated by all users of these little machines.

List Price \$4.00.

GOODELL-PRATT COMPANY

Greenfield, Mass.

WELL DRILLING Machines

Over 70 sizes and styles, for drilling either deep or shallow wells in any kind of soil or rock. Mounted on wheels or on skids. With engines or horse powers. Strong, simple and durable. Any mechanic can operate them easily. Send for catalog.

WILLIAMS BROS., Ithaca, N. Y.

SPRING HUB for Bicycles, Motor Cycles, Automobiles. Holds several World's Records for speed. Relieves and breaks jar below the axle, thereby saving at least half the wear on tires. Absolutely guaranteed. Frank Schmitz & Sons
560-564 Orleans St. - CHICAGO, ILL.

THE SPINAL BRUSH

Circulation is as Necessary as Ventilation. It Insures Health and Prevents Sickness. The brush possesses no medical properties, but when properly applied positively affords instant relief to those who suffer from BACKACHE, HEADACHE, PAIN, NEURALGIA, NERVOUS DISORDERS of any kind that can be cured by FRICTION, CIRCULATION OF STIMULATION. Recommended by the Medical Profession. Brush with full instructions sent postpaid on receipt of One Dollar. The English Syndicate A. & P. Co. Room 105 St. James Building, 1131 Broadway, New York

JEFFREY ELEVATING--CONVEYING--POWER

Transmission--Screening--Dredging--Coal Cutting
Drilling--Hauling--Washing Machinery.

For Catalogues address THE JEFFREY MFG. CO. COLUMBUS, OHIO, U.S.A. NEW YORK DENVER

THE IMPROVED BOSTON GARTER

IS KNOWN and WORN Every Pair Warranted

The Name is stamped on every loop—

The **Velvet Grip**

CUSHION BUTTON CLASP

Lies flat to the leg—never Slips, Tears nor Unfastens

ALWAYS EASY

Geo. Frost Co., Makers, Boston, Mass., U. S. A.

Send 50c. for Silk, 25c. for Cotton, Sample Pair.

REFUSE ALL SUBSTITUTES

Squabs Pay Best Hens

Easier, need attention only part of time, bring big prices. Raised in one month. Attractive for poultrymen, farmers, women. Send for FREE BOOKLET and learn this immensely rich home industry.

PLYMOUTH ROCK SQUABS CO., 298 Atlantic Ave., Boston, Mass.

HOW FAR DO YOU WALK IN A DAY?

Did it ever occur to you that perhaps you walked miles just going around your home, shop or office? Perhaps you'd like to know. If so, get a Pedometer. A Pedometer is an ingenious affair that goes when you go and stops when you stop. This instrument has heretofore cost from ten to fifteen dollars. It is not a toy, but an accurate and valuable recorder of distances.

YOU CAN GET A FREE!

by sending us \$1.00 for a year's subscription to MODERN MACHINERY, our monthly magazine, which will keep you posted on the great progress which is being made in the machinery world (and if you would keep abreast of the times you must read MODERN MACHINERY), interestingly written, well illustrated. Sample Copy, 10c; \$1.00 per year—and a Pedometer, FREE!—Subscribe Now.

MODERN MACHINERY COMPANY, 813 Security Building, CHICAGO, ILLINOIS

FOR GUNSMITHS, TOOL MAKERS, EXPERIMENTAL & REPAIR WORK, ETC.

From 9-in. to 13-in. swing. Arranged for Steam or Foot Power, Velocipede or Stand-up Treadle. Send for Lathe Catalog. **W. F. & JNO. BARNES CO. Established 1872. 1999 Ruby St., Rockford, Ill.**

Automatic Hand Winder

Patent Applied for. A True and Triumphant answer to the demand for the only ever reduced. Winds with mandrel in vise or lathe. Made in two sizes: No. 1, capacity to 3-32, \$1.25; No. 2, capacity to 3-16, \$1.75. By mail.

The Brennan Motor

14 H. P. develops rated power at 700 R. P. M., developed 16 H. P. at 800, and 18 H. P. at 960. Motors are used for automobile marine and stationary purposes They are sure and quick to run

IS GUARANTEED

BRENNAN MOTOR CO. - Syracuse, N. Y.

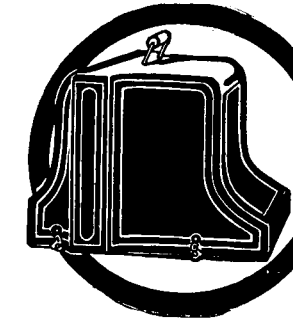

Remington Typewriters

are strong and durable machines—every user says so.

Remington Typewriter Co. 327 Broadway, New York.

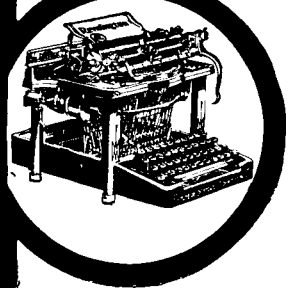

A Great Repository of Practical & Scientific Information One of the Fullest, Freshest, and Most Valuable Handbooks of the age. Indispensable to Every Practical Man

SIXTEENTH THOUSAND. PRICE \$2.00 Free of Postage to any Address in the World

The Techno-Chemical Receipt Book

Containing Several Thousand Receipts, covering the Latest, most Important and most Useful Discoveries in Chemical Technology, and their Practical Application in the Arts and the Industries.

HENRY CAREY BAIRD & CO. INDUSTRIAL PUBLISHERS, BOOKSELLERS & IMPORTERS 810 Walnut St., Philadelphia, Pa., U.S.A.

THOUSANDS are successful and gaining better positions and salaries studying Electrical Engineering, Steam Engineering, Mechanical Engineering, Mechanical Drawing, Electric Motorman's Course, Dynamo Tender's Course, Arithmetic, Algebra, by mail. Text-books free. Students helped to positions. Write for free catalogue. ELECTRICAL ENGINEER INSTITUTE

WE CAN SAVE YOU 25 TO 75% ON TYPEWRITERS of all makes. Send for samples of writing, prices, and catalogue. Machines shipped for inspection. NEW YORK, CHICAGO, BOSTON, KANSAS CITY, ST. LOUIS, SAN FRANCISCO



The Light Running YOST is easy to operate. Its Beautiful Work is easy to read. Our Unusual Catalogue is easy to understand. Why not send for the UNUSUAL CATALOGUE and learn of the BEAUTIFUL WORK done by the LIGHT RUNNING YOST? Sent free. YOST WRITING MACHINE CO., 245 B'way, New York.

MILLS FOR ALL MATERIALS. OUR BUSINESS IS TO MAKE MACHINERY FOR GRINDING GRAIN, CRUSHING ROCKS AND PULVERIZING ALL HARD SUBSTANCES. WE HANDLE ALL KINDS OF MATERIALS FROM COTTON-SEED TO ROOTS AND HERBS. BY AN UNEXCELLED PROCESS, IF YOU WANT ANY KIND OF A MILL OR GRINDING MACHINE, COME TO US AND YOU WILL GET THE BEST AND STILL SAVE MONEY. DEAL WITH US ONCE AND YOU WON'T CHANGE. SEND FOR CATALOG NO 4. MUNCY, PA.

Does This Fact Indicate Merit? 575,000 LINDSAY LIGHTS Sold Since January 1, 1904. LINDSAY LIGHTS are intended for use on manufactured, natural or gasoline machine gas. They burn about four feet of gas per hour and deliver up to 300 candle-power, equaling the candle power of three ordinary incandescent gas burners on one-third the consumption. Fastest selling article now on the market. One Lindsay Light sells another. Reliable representation wanted in all parts of the world where gas is used. Very special inducements for foreign representation. Handsome complete illustrated book and full particulars for the asking. Write Now. If you forget it you will regret it. LINDSAY LIGHT COMPANY DEPT. S CHICAGO, U. S. A. Cables - "LINSLITE," Lieber's Code

Table listing various mechanical parts and their prices, including wire netting, wrenches, and spoons.

DESIGNS.

Table listing designs for items like chaplets, folding chairs, and spoons.

TRADE MARKS.

Table listing trade marks for various products such as blankets, boots, bottles, and machinery.

LABELS.

Table listing labels for various products including antiseptics, ribbons, and cigars.

PRINTS.

Table listing prints for various items like antiseptic powder, boroline, and playing cards.

A printed copy of the specification and drawing of any patent in the foregoing list, or any patent in print issued since 1863, will be furnished from this office for 10 cents, provided the name and number of the patent desired and the date be given. Address Munn & Co., 361 Broadway, New York.

Canadian patents may now be obtained by the inventors for any of the inventions named in the foregoing list. For terms and further particulars address Munn & Co., 361 Broadway, New York.

WANTED.—ELEVEN SKILLED MACHINE draftsmen at \$4.00 per diem. A com ditive examination will be held about December 1, 1904, at the Washington Navy Yard.

A RARE OPPORTUNITY for men with small capital to secure control of our new patent Eye-glass in specified territory. Write to-day as territory is being assigned rapidly. BRIGGS OPTICAL COMPANY, Sale Dept. Rochester, N. Y.

SPECIAL MANUFACTURING. DIES AND STAMPINGS TO ORDER. SPECIAL MACHINERY—MODELS—EXPERIMENTAL WORK. DROP FORGING DIES AND DROP FORGINGS.

ICE MACHINES. Corliss Engines, Brewers' and Bottlers Machinery, THE WILVER MFG. CO. 899 Clinton St., Milwaukee, Wis

CHEMICAL EXAMINATIONS OF ALL KINDS. DR. H. C. STIEFEL, Bissell Block, Pittsburgh, Pa.

MODELS & GEARS. CATALOGUES FREE. UNION MODEL WORKS 193 CLARK, CHICAGO.

MODELS & EXPERIMENTAL WORK. Inventions developed. Special Machinery. E. V. BAILLARD, Fox Bldg., Franklin Square, New York.

ELECTRICITY HOW TO MAKE. A Dynamo, Storage Battery, Telegraph Instrument, Electric Bell, Motor. 5 Books, 10c. each. BUBIE PUBLISHING CO., Box 5, LYNN, MASS.

Dies, Tools, Models and Special Machinery. HOEFT & MOORE, Chicago, U. S. A.

MODEL AND EXPERIMENTAL WORK. Electrical and Mechanical Instruments. Small Mach'y. EDWARD KLEINSCHMIDT, 82 W. Broadway, New York

Manufacturers of HARDWARE SPECIALTIES. Contract Manufacturers and will market articles of merit. LORIMER MFG. CO., 153 S. Jefferson St., Chicago, Ill.

MODELS CHICAGO MODEL WORKS. ESTABLISHED 1867. 179 E. MADISON ST. CHICAGO, ILL.

DRYING MACHINES. S. E. WORRELL Hannibal, Mo.

Embossing and Stationery Dies, Seals, etc. Drop Postal for my leaflets. JOHN KIOLA, Engraver, R. 39, 155 W. Madison St., Chicago, Ill.

INVENTORS. We manufacture METAL SPECIALTIES of all kinds. order; largest equipment; lowest prices. Send sample or model for low estimate and best expert advice FREE. THE EAGLE TOOL CO. Dept. W, Cin'ti, O

SPLITDORF SPARK COILS. 25 VANDEWATER ST. N.Y.

SETS OF CASTINGS OF MODEL ENGINES. SEND 10¢ FOR 126 PAGE ILL. CATALOGUE. ALSO TOOLS, GEAR WHEELS & PARTS OF MODELS. GOODNOW & NIGHTMAN BOSTON

Multiplying table showing the calculation of 4231 multiplied by 3214, resulting in 13598434.

Multiply This in Your Head

Wouldn't you like to be able to figure this and hundreds of other similar problems in your head? Wouldn't you like to be able to add, subtract, multiply, and divide any problem almost instantly without writing any partial product—to be able to simply write the answer?

Our Free Book, "Rapid Calculation"

thoroughly explains a method which will make you a master of figures. It describes a system by which you can figure instantly the most intricate sums in your head; handle groups of figures and fractions as easily as single whole figures; in fact, cut the work of figuring in two.

A better position and a large salary have come to hundreds who have read this book. If you want to better your position, to increase your salary, to make yourself worth more to yourself and your employer, to hold the whip-hand in financial transactions, to make your work easy and interesting instead of tiresome, you should write for this book at once. It will cost you nothing but the trouble of asking for it. A postal will bring it to your very door. It may cost you a good position or a valuable promotion to neglect this opportunity. Write for it today before you forget it. Address 344 B Commercial Bldg. Rochester, N. Y.

COMMERCIAL CORRESPONDENCE SCHOOLS, 344 B Commercial Bldg. Rochester, N. Y.

MAILS CLOSE on ELGIN TIME. Elgin Watches regulate the world's business, public and private. Every Elgin Watch is fully guaranteed. All jewelers have Elgin Watches, in both men's and women's sizes, and in all varieties of cases. "Timemakers and Timekeepers," an illustrated history of the watch, sent free upon request. ELGIN NATIONAL WATCH CO., ELGIN, ILL.

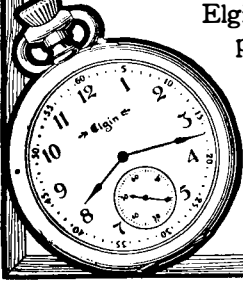

DON'T BUY GASOLINE ENGINES UNTIL YOU INVESTIGATE. "THE MASTER WORKMAN," a two-cylinder gasoline engine superior to all one cylinder engines; revolutionizing gas power. Costs Less to Buy and Less to Run. Quickly, easily started. No vibration. Can be mounted on any wagon at small cost—portable, stationary or traction. Mention this paper. SEND FOR CATALOGUE. THE TEMPLE PUMP CO., 609 N. Meagher & 15th St., Chicago. THIS IS OUR FIFTY-FIRST YEAR.

ANY ONE CAN PRINT WITH THE MODEL PRESS. Full Course of Instructions in Printing Free. Over 50,000 Model Printing Presses Sold. Prints from a Card to a small Newspaper. IT'S NOT A TOY, IT'S A PRACTICAL PRINTING MACHINE. Highest Award at World's Fairs. Established 30 years. Send stamp for illustrated catalogue 212 at once. Prices \$5.00 to \$150.00. Every Press Guaranteed. MODEL PRINTING PRESS CO., 104-6 North 10th St., Philadelphia, Pa.

LEARN TO WRITE ADVERTISEMENTS. The man who can write advertisements has a decided advantage over others—he receives a high salary. We will teach you thoroughly and practically by correspondence, enabling you to earn from \$25 to \$100 per week. Send for our handsome prospectus and a list of hundreds of successful graduates now receiving salaries up to \$100 per week, mailed free. PAGE-DAVIS COMPANY. Address (Suite 20, 90 Wabash Ave., Chicago. Other office 1 Suite 20, 150 Nassau St., New York.

Send For This Atlas

An Atlas of the World containing a complete series of 106 Newly Engraved and Colored Maps, covering every portion of the Globe, including separate maps of every State and Territory of the Union and Special Maps of our new possessions. It also contains a short history of the United States, with illustrations of the interior and exterior of the Capitol and other public buildings of Washington, D. C., together with half-tone photographs of all the Presidents of the United States from Washington to Roosevelt, and short biographical sketches of each. A copy of this handy Atlas will be mailed to any address by the Pittsburgh Bank for Savings of Pittsburgh, Penn., on receipt of five two-cent stamps to cover postage and mailing expenses. When writing, ask the bank to enclose you a free copy of Booklet No. 29, if you are interested in securing a safe and profitable investment for your savings or surplus funds.

Send For It To-Day

You'll find it always convenient to have as a useful and instructive book Montgomery & Co.'s Tool Catalogue. The new edition has 704 pages and is copiously illustrated. Pocket size 3 1/2 x 4 1/2 ins. Sent by mail for 25c. MONTGOMERY & CO., 105 Fulton St., New York City.

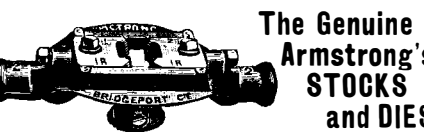

The Genuine Armstrong's STOCKS and DIES. Acknowledged to be the best. Different sizes and capacities. Write for catalog. THE ARMSTRONG MFG. CO., Bridgeport, Conn. New York Office, 139 Centre Street

Telegraphy

Circular free. Wonderful automatic teacher. 5 styles. 42 pp. OENIGRAPH CO., Dept. 82, 89 Cortlandt St., New York.

STONE AXES—TO ETHNOLOGISTS

FOR SALE: A collection of 100 Jamaica Carib Celts, mounted in 5 trays in mahogany cabinet. Photo 25 cents. Apply to J. F. BRENNAN, Public Works Office, Savanna-la-Mar, Jamaica, West Indies.

WINTON

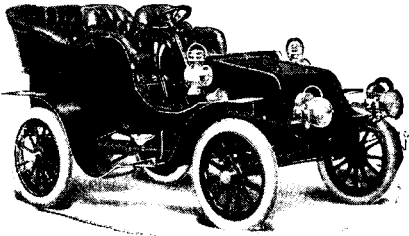

If you do not investigate the WINTON before you buy a motor car you will not get its equal. Completely equipped, \$2,500 f. o. b. Cleveland; without top, \$2,300. Prompt deliveries.

THE WINTON MOTOR CARRIAGE CO., Cleveland, O., U.S.A.

Orient Tonneau Car

Price \$525

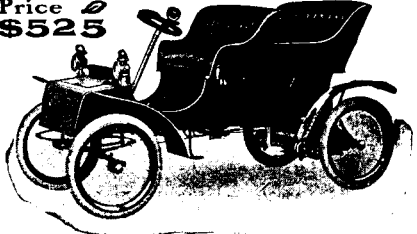

Speed twenty miles per hour. Will climb all ordinary grades. The best car for the price in the world.

Write for catalogue
WALTHAM MANUFACTURING CO.
Waltham, Mass.



"How To ILLUSTRATE" AND "ART OF CARICATURE" \$1.00 \$.50

Teach thoroughly drawing and illustrating, in all its branches. Price, both books, \$1.25 post-paid. 16 pg. illus. Catalogue on request.

BROWN PUBLISHING CO., Room 965 114 Fifth Ave., New York.

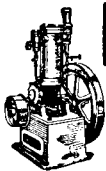

CHARTER

GAS and GASOLINE For All Work. Stationaries, Portables, Hoisters, Pumps, Sawing & Boat Outfits.

Send for Catalogue and Testimonials
State Your Power Needs.

CHARTER GAS ENGINE CO., Box 148, STERLING, ILL.



PROMPT DELIVERIES
Packard Motor Car Co., Dept. 5, Detroit, Mich., U.S.A.
NEW YORK AGENTS: M.A.L.A.M.
Packard Motor Car Co., of New York, 317-319 W. 59th St.

"Patent Steel Wire Rope"
HAS NO SUPERIOR FOR HOISTING OR HAULAGE.

BRODERICK & BASCOM ROPE CO.
ST. LOUIS, MO.

What is Daus' Tip-Top?
TO PROVE that Daus' "Tip-Top" is the best and simplest device for making 100 copies from pen-written and 50 copies from typewritten original, we will ship complete duplicator, cap size, without deposit, on ten (10) days' trial.

Price \$7.50 less 5% Net trade discount of 33% per cent, or \$5

The Felix A. B. Daus Duplicator Co., Daus Bldg., 111 John St., New York

Microscopes
Our Microscopes, Microtomes, Laboratory Glassware, Chemical Apparatus, Chemicals, Photo Lenses and Shutters, Field Glasses, Projection Apparatus, Photo-Micro Cameras are used by the leading Laboratories and Government Departments Round the World.

Catalogs free.

BAUSCH & LOMB OPT. CO.
ROCHESTER, N. Y.

JESSOP'S STEEL THE VERY BEST FOR TOOLS, SAWS, ETC.
Wm. Jessop & Sons, Ltd., 91 John St., New York

1854 - 1904
WALTHAM WATCHES
HAVE STOOD THE TEST OF TIME.

"The Perfected American Watch," an illustrated book of interesting information about watches, free upon request.

AMERICAN WALTHAM WATCH COMPANY,
WALTHAM, MASS.



W. L. DOUGLAS

UNION MADE. **\$3.50 SHOES FOR MEN.**
W. L. Douglas makes and sells more men's \$3.50 shoes than any other manufacturer in the world.

The reason W. L. Douglas \$3.50 shoes are the greatest sellers in the world is because of their excellent style, easy fitting and superior wearing qualities. If I could show you the difference between the shoes made in my factory and those of other makes and the high-grade leathers used, you would understand why W. L. Douglas \$3.50 shoes cost more to make, why they hold their shape, fit better, wear longer, and are of greater intrinsic value than any other \$3.50 shoe on the market to-day, and why the sales for the year ending July 1, 1904, were

\$6,263,040.00.

W. L. Douglas guarantees their value by stamping his name and price on the bottom. Look for it—take no substitute. Sold by shoe dealers everywhere. *Fast Color Eyelets used Exclusively.*

Superior in Fit, Comfort and Wear.

"I have worn W. L. Douglas \$3.50 shoes for the last twelve years with absolute satisfaction. I find them superior in fit, comfort and wear to others costing from \$5.00 to \$7.00."

B. S. McCUE, Dept. Col., U. S. Int. Revenue, Richmond, Va.

W. L. Douglas uses Corona Coltskin in his \$3.50 shoes. Corona Colt is conceded to be the finest Patent Leather made.

SEND FOR CATALOGUE GIVING FULL INSTRUCTIONS HOW TO ORDER BY MAIL.

W. L. DOUGLAS, Brockton, Mass.

Price pales into insignificance beside the fact that "Taylor Old Style" roofing tin will last in good condition seventy-three years. It is so good that you forget the price, yet the price is but little more than common kinds.

This and other roof-proof truths are in the book, "A Guide to Good Roofs," free to all who want weather-tight roofs. Architects, builders and metal workers will, if they send their names and addresses, receive free each month "The Arrow," a little paper which hits the bull's eye more frequently than some publications more pretentious. It also tells about tin.

N. & G. TAYLOR COMPANY
ESTABLISHED 1810
Philadelphia

THE MIETZ & WEISS **KEROSENE** and GAS ENGINE
SIZES FROM 1 to 60 H. P.
Send for Catalogue.

burns KEROSENE cheaper and safer than gasoline. Automatic, simple, reliable. No electric battery or flame used. Perfect regulation. Belted or directly coupled to dynamo for electric lighting, charging storage batteries, pumping and all power purposes.

A. MIETZ,
128-138 Myer St., New York.
ADOPTED BY U. S. GOVERNMENT.
Highest Award, direct coupled Generator Set, Paris Exposition, 1901.
Gold Medal, Pan American Exhibition, 1902.

position, 1901. Gold Medal, Charleston, S. C., Exposition, 1902.

Radium

OUR NEW SKELETON WATCH
New England
WATCHES
READY FOR DELIVERY OCTOBER 1st

Our New Skeleton Watch not only shows you the time, but how time is made. Accurate time at that. Ready for delivery October 1st. For sale by all Jewelers.

THE NEW ENGLAND WATCH CO., 37 @ 39 Maiden Lane, New York
7 Snow Hill, London, England

HAPGOOD DOUBLE FLUE HOT BLAST RANGE
Guaranteed to save one-third in fuel over any other range. Material and workmanship unexcelled. Guaranteed to be satisfactory or your money refunded. (See cut.)

Our Hapgood Anti-Trust Range, \$21.75
A 6-hole range, full nickel trimmings and aluminum coated reservoir. Most perfect low priced range made. Send for complete Catalogue showing our full line, at least 1000 other articles, at factory cost plus onesmall profit.

HAPGOOD MFG. CO., 237 Front St., ALTON, ILL.
The only manufacturing company in the world in their line selling direct to the consumer.

YOUR EYE



RIGHT HERE!
Now let us send you the Free Book telling all about it. We will also send you Prof. Sloan's fifty original suggestions for improving your handwriting.

Conklin's SELF-FILLING PEN
"The Pen That Fills Itself"

Dip pen in any ink well or any ink, press lever and operation is over. As a matter of cleanliness, comfort and convenience don't you owe it to yourself to learn more about this perfect pen?

If you will let us send you our beautiful new illustrated catalogue, it will make you a CONKLIN enthusiast.

The Conklin Pen Co., 119 Madison Ave., Toledo, Ohio
Represented in Great Britain by American Agencies, Ltd., 38 Shoe Lane, Farringdon St., London, E. C. 2. In Australia by Rae, Munn & Gilbert, 47 Market St., Melbourne.

BARAINS IN MARINE ENGINES.
1/2 H. P. to 80 H. P. 2 and 4 cycle. Single, double, triple and 4 cylinders, auto marine and working engines. High and low speed. The best on the market for auto, speed or racing boats, launches, cruisers and auxiliary yachts. We also manufacture the only true Solid Reversible Propeller Wheel, the best wheel in the world. Write for full descriptive catalog B. Agents wanted in every country.

Michigan Motor Co., Grand Rapids, Mich.

BOYS, WRITE TO US
and let us show you how easy it is to become an electrician. Our catalog for boys shows everything in motors, dynamos and electrical goods. Sent free to anyone. As a special inducement we send this motor for \$1.50 with directions for operating. Send 15c in stamps to pay mailing charges. Julius Andrae & Sons Co., 484 West Water St., Milwaukee, Wis.

\$1.50

The Spectroscope, giving most brilliant effects, postpaid, \$9.00. Radian Tubes, containing Radium mixture for demonstrating fluorescence, \$7.50. Newton's Radiometer, demonstrating by means of magnetic light the electrical properties of Radium. The N. Radiometer for demonstrating the N. Rays. Radium of both high and low activity. Radiographic Lantern Slides. Uranium Concentrates. Pitchblende, Willemitite. Write for circulars to Williams, Brown & Earle, Dept. 6, 913 Chestnut St., Philadelphia

GOLD GALVANIZING.
AMERICAN PROCESS. NO ROYALTIES.
SAMPLES AND INFORMATION ON APPLICATION.

NICKEL
AND
Electro-Plating
Apparatus and Material.
THE
Hanson & VanWinkle
Co.,
Newark, N. J.,
92 William St., N. Y.,
30 & 32 S. Canal St.
Chicago.

Waterman's Ideal Fountain Pen
For Quick Business

It works with 'phone and ticker to keep up with the flash of business thought. Never tires, never fails, simple in construction, easily filled.

We have a booklet on the subject and will send you a list of most convenient stores where you can buy

L. E. Waterman Co.
173 Broadway - New York

Large Contracts Solicited

Our factories are so numerous and so completely equipped that we can compete successfully on large contracts—such as sheet steel stampings, general manufacturing and machine shop work:

Pope Manufacturing Co.
21 Park Row, New York City

THE FRANKLIN MODEL SHOP
Inventors, amateur machinists, schools and colleges furnished with anything in metal from a single piece to a complete working model. Drawings and designs worked out from inventors' ideas. Write for estimates. Send for booklet No. 9, free.

PARSELL & WEED, 129-131 W. 81st St., New York

"NUTSHELL" Safety Razor
The Best, Safest, Quickest, Cleanest, Smallest and Most Practical Razor in the World

\$1.00
Special Offer.—On receipt of \$1.00 I will mail you one Nutshell Safety Razor, One Razor Strop and Ten Coupons (regular price of razor and strop \$1.25). Money refunded if not satisfactory.

Sold to Consumers only
E. L. SCHMITZ
39 Greenpoint Avenue, Brooklyn, N. Y.

Scales
All varieties at lowest prices. Best Railroad Track and Wagon or Stock Scales made. Also 100 useful articles, including Saws, Sewing Machines, Bicycles, Tools, etc. save Money. Lists Free. CHICAGO SCALE CO., Chicago, Ill.

IDEAL STEAM STAMP
Will pulverize all kinds of milling ore. It is economical in the use of power. It will reduce to forty mesh 10 to 15 tons per day; operated by steam or compressed air. Can be installed at small cost. Is equally efficient for large or small plant. Prospects can quickly be made paying properties by the use of The Ideal Stamp and suitable concentrating table.

THE IDEAL COMPANY
89 State St., Boston, Mass.
The Henrie & Bolthoff Mfg. and Supply Co., Denver, Col., General Agents

The Apple
For Gas Engines, Launches, Automobiles, etc.
No more belt, battery and commutator troubles. Dirt and waterproof. Easily attached, increases power and speed. Send for full particulars on our storage batteries, spark coils, timing devices, spark plugs, and all kinds of ignition apparatus.

The Dayton Electrical Mfr. Co. SPARKER
98 Reibold Bldg., Dayton, Ohio.

PARALLEL CHESLEY & Co
CLAMPS ALL SIDES—U.S.A.
15 to 21 Clinton Street