

SCIENTIFIC AMERICAN

[Entered at the Post Office of New York, N. Y., as Second Class Matter. Copyright, 1897, by Munn & Co.]

A WEEKLY JOURNAL OF PRACTICAL INFORMATION, ART, SCIENCE, MECHANICS, CHEMISTRY, AND MANUFACTURES.

Vol. LXXVII.—No. 2.
ESTABLISHED 1845.

NEW YORK, JULY 10, 1897.

[\$3.00 A YEAR.
WEEKLY.]



ROTARY PLOW PUSHED BY THREE ENGINES.



FREIGHT TRAIN BURIED IN A TWELVE FOOT DRIFT.

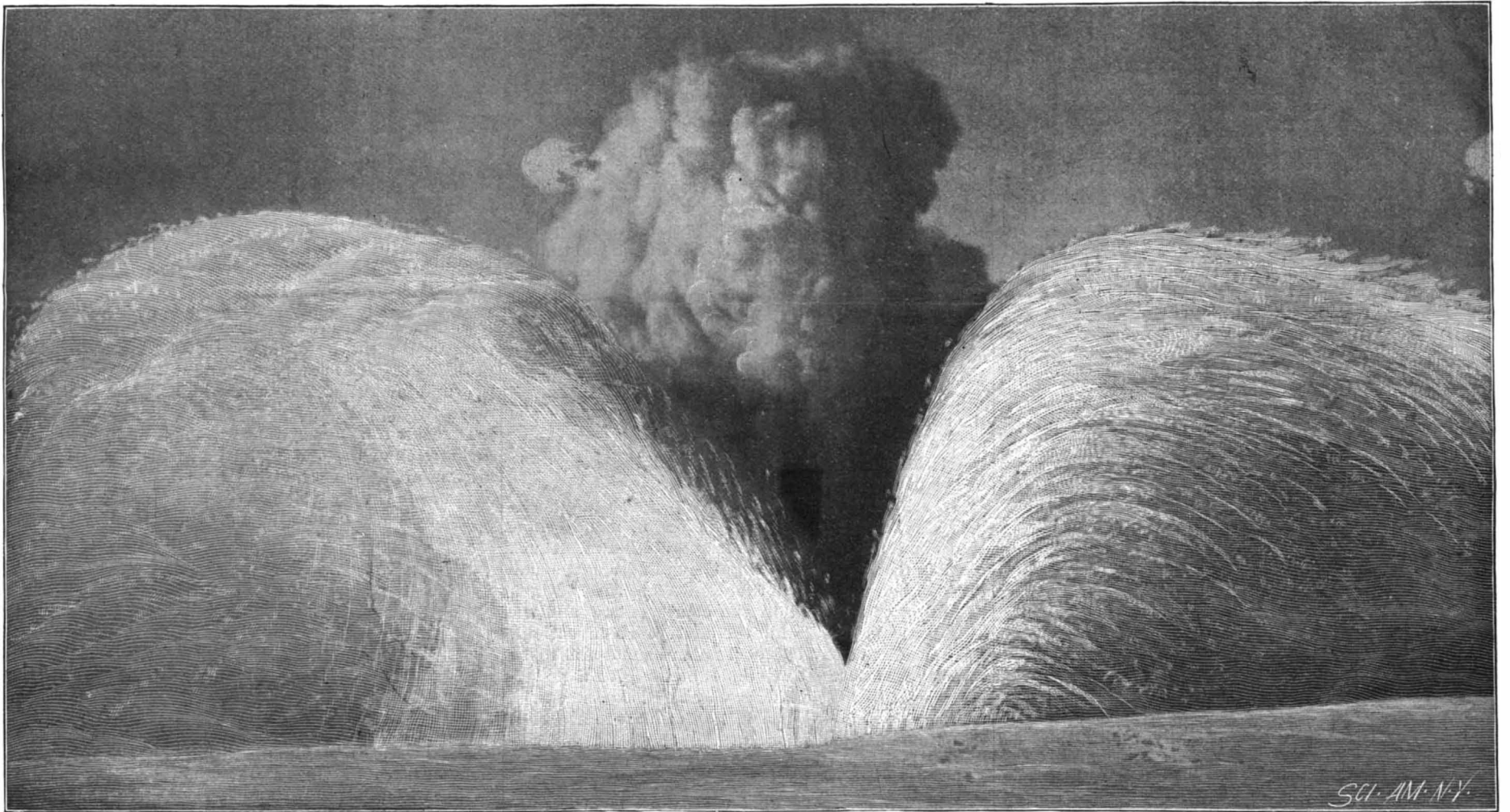

OLD STYLE "SNOW BUCKER" STRIKING A DRIFT AT FULL SPEED.

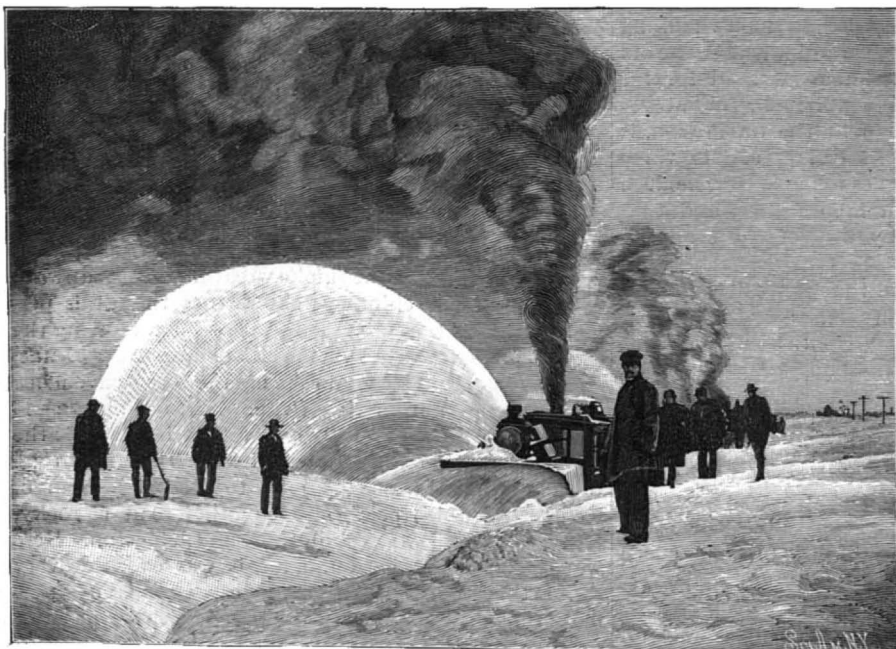

ROTARY CLEARING CUT THREE-QUARTERS OF A MILE LONG.

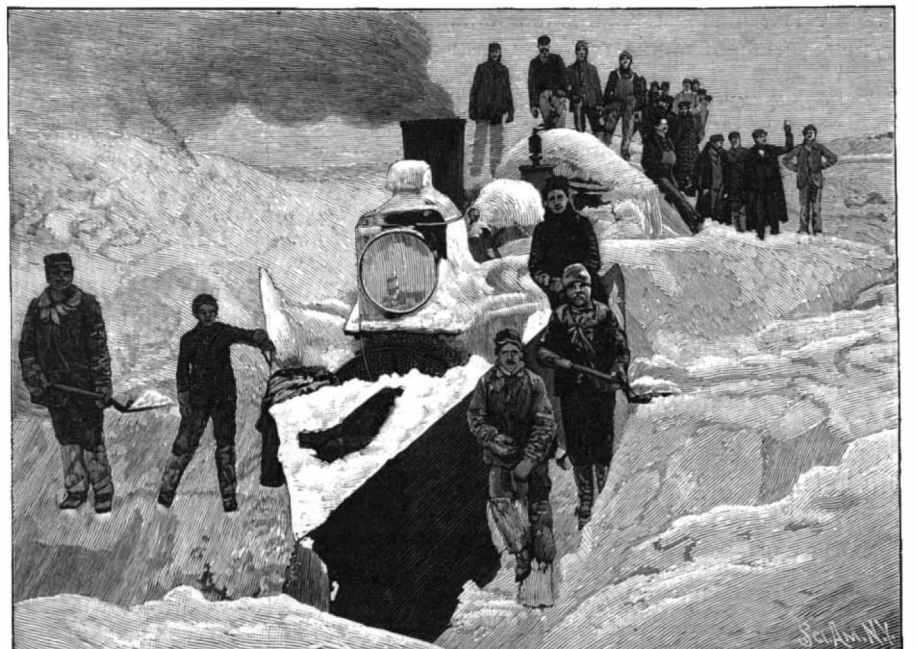

DIGGING OUT THE ENGINE OF A FREIGHT TRAIN.

FIGHTING SNOW ON THE RAILROADS OF THE NORTHWEST.—[See page 22.]

Scientific American.

ESTABLISHED 1845

MUNN & CO., - - - EDITORS AND PROPRIETORS.

PUBLISHED WEEKLY AT

No. 361 BROADWAY, - - NEW YORK.

TERMS FOR THE SCIENTIFIC AMERICAN.

(Established 1845.)

One copy, one year, for the U. S., Canada or Mexico.....\$3.00
One copy, six months, for the U. S., Canada or Mexico..... 1.50
One copy, one year, to any foreign country, postage prepaid, £1 16s. 5d. 4.00

The Scientific American Supplement

(Established 1876)

is a distinct paper from the SCIENTIFIC AMERICAN. THE SUPPLEMENT is issued weekly. Every number contains 16 octavo pages, uniform in size with SCIENTIFIC AMERICAN. Terms of subscription for SUPPLEMENT, \$5.00 a year, for the U. S., Canada or Mexico. \$6.00 a year, or £1 4s. 8d., to foreign countries belonging to the Postal Union. Single copies 10 cents.

Building Edition of Scientific American.

(Established 1885.)

THE BUILDING EDITION OF THE SCIENTIFIC AMERICAN is a large and splendidly illustrated periodical, issued monthly, containing floor plans and perspective views pertaining to modern architecture. Each number is illustrated with beautiful plates, showing desirable dwellings, public buildings and architectural work in great variety.

Export Edition of the Scientific American

(Established 1878)

with which is incorporated "LA AMERICA CIENTIFICA E INDUSTRIAL," or Spanish edition of the SCIENTIFIC AMERICAN, published monthly, uniform in size and typography with the SCIENTIFIC AMERICAN. Every number contains about 100 pages, profusely illustrated. It is the finest scientific industrial export paper published.

MUNN & CO., Publishers, 361 Broadway, New York.
The safest way to remit is by postal order, express money order, draft or bank check. Make all remittances payable to order of MUNN & CO.

NEW YORK, SATURDAY, JULY 10, 1897.

Contents.

(Illustrated articles are marked with an asterisk.)

Andria, steam yacht*..... 24
Ball pulverizer, Morris*..... 25
Baths, Roman*..... 25
Bicycle lamp, an electric*..... 20
Bicycle sail attachment, Lotherington's*..... 20
Bicycle tire, a pneumatic*..... 20
Bicycle tire, proof*..... 20
Bicycle, 200 miles on in a day..... 18
Bicyclists, middle-aged, a caution to..... 21
Books, new..... 23
Bottle washer, Kersten's*..... 20
Brazier for bicycle work*..... 20
Bulb lubricator, Tracy's*..... 20
Campbor making, Nagel's process*..... 23
Can washing machine, Seuffert's*..... 23
Cigar lighter, Brooke's*..... 23
De Volon Wood, Prof., death of..... 19
Engine, rotary, Almond's*..... 23
Engine, rotary, Fieischer's*..... 23
Eyelight and the electric light..... 19
Feedwater regulator, Berg's*..... 23
Hydrocarbon burner, Barrett's*..... 23
Insects, the annual battle with..... 23
Inventions, interesting recent*..... 26
Inventions recently patented..... 28
Librarian of Congress, a new..... 19
Magnet, field, Turner's*..... 26
Mark, a Carthaginian*..... 21
Mayflower, steam yacht*..... 21
Medicines, the origin of..... 24
Mail service, new rapid harbor..... 19
Mosquito remedy..... 20
Nail, a many century embedded..... 20
Notes and queries..... 23
Patents granted, weekly record of..... 23
Patents, lottery induced..... 19
Pear tree, a remarkable*..... 21
Plant protector, Taylor's*..... 20
Railroad snow plows at work*..... 17
River St. Lawrence, deepening the..... 19
Science, Nobel's bequest to..... 18
Science notes..... 23
Snow fighting on railroads*..... 17
Sounding board, Livingston's*..... 26
Steam yachts, some notable*..... 24
Valve, Marchaut & Dormoy's*..... 28

TABLE OF CONTENTS OF

Scientific American Supplement

No. 1123.

For the Week Ending July 10, 1897.

Price 10 cents. For sale by all newsdealers.

I. CIVIL ENGINEERING.—The Mungsten Bridge.—A description of a very interesting bridge, which has just been completed in Germany.—1 illustration..... 17351
II. ECONOMICS.—British versus American Manufactured Products The Population of Russia..... 17352
III. ELECTRICAL ENGINEERING.—The Accomplished Utilization of Niagara.—This article gives the various companies who are utilizing the power, and the amount of power used by each is given..... 17345
Three Phase Motor at Bellegarde.—Description of an interesting motor used in long distance transmission.—4 illustrations..... 17343
IV. ENTOMOLOGY.—The Theater of Insects..... 17355
V. GEOLOGY.—The International Geological Congress in Russia..... 17353
VI. HYDRAULIC ENGINEERING.—The Use of Turbines with a Horizontal Shaft for Running Dynamos.—8 illustrations..... 17344
VII. LOCOMOTIVE ENGINEERING.—Express Compound Locomotive with Auxiliary Gear.—This article gives very full details of a most complicated and interesting locomotive for the Bavarian state railways.—5 illustrations..... 17346
VIII. MECHANICAL ENGINEERING.—Punching and Shearing Machines.—2 illustrations..... 17351
IX. MEDICINE AND HYGIENE.—Oxygen, Fresh Air and Health.—A common sense and helpful article.—By L. W. CURTIS, M.D..... 17348
X. MISCELLANEOUS.—Confetti and Serpentine.—2 illustrations..... 17357
Engineering Notes..... 17349
Miscellaneous Notes..... 17349
Selected Formulae..... 17349
Drouth in Australia..... 17345
XI. NATURAL HISTORY.—Color in Animals: Its Causes and Uses.—An abstract from a lecture by Dr. Benjamin Sharp, giving some wonderful examples of the uses of color among animals..... 17356
XII. PHYSICS.—The Bakerian Lecture on the Mechanical Equivalent of Heat.—Abstract of a lecture by Prof. Osborne Reynolds..... 17355
XIII. POULTRY.—The Standard Varieties of Chickens.—By JOHN MICHELS.—This article illustrates the principal varieties of chickens in the United States.—12 illustrations..... 17354
XIV. TECHNOLOGY.—Babbitt Metals.—By C. VICKERS.—Six formulas for this important bearing metal..... 17352
The Cultivation of Chicle for Chewing Gum in Mexico.—Important contribution to the limited literature on this subject..... 17357

THE NOBEL BEQUEST TO SCIENCE.

Look at it from whatever point of view we may, it must be admitted that the present age is pre-eminently the age of science. Whatever the future may have in store, it is certain that the past history of the race cannot show another period in which human life was so completely envired, dominated and impelled by a master influence as it is to-day.

Of all the forces above mentioned, religion—as is natural and right—has left, and will continue to leave, behind the most enduring monuments of its work. But it cannot be said that even this beneficent influence has, in any age, impressed itself upon the life and works of the race in the supreme degree that science is doing in the latter half of this century.

The world has lately witnessed a striking evidence of the tendency to give the claims of science their rightful recognition in the splendid bequest which was made by the great Swedish inventor, Alfred Nobel. In leaving his vast fortune of nine millions of dollars for the promotion of science and the furtherance of civilization, he has not only endowed systematized and individual scientific research, but he has planted in the minds of men a valuable suggestion, which will not fail to bear fruit in the years to come.

The will provides that the income from Mr. Nobel's fortune shall be divided into five equal portions, which are to be distributed as follows: One-fifth to the person having made the most important discovery or invention in the science of physics, one-fifth to the person who has made the most eminent discovery or improvement in chemistry, one-fifth to the one having made the most important discovery with regard to physiology or medicine, one-fifth to the person who has produced the most distinguished idealistic work of literature, and one-fifth to the person who has worked the most or best for advancing the fraternization of all nations and for abolishing or diminishing the standing armies, as well as for the forming or propagation of committees of peace.

Now the measure of stimulus which will be given to scientific investigation and social advancement by the announcement that five prizes, each of \$60,000 to \$80,000 value, are to be bestowed upon successful invention and discovery, depends in the first place upon the realization by the world at large of the bona fide nature of the bequest, and further upon the public conviction that five separate fortunes are actually to be bestowed every year.

The scheme is so novel and the reward so fabulous—being far beyond anything in the way of money value before offered for human competition—that it will possibly receive but a passing thought from the majority of busy workers in the world of science. But if the bequest is upheld in the courts of law and the awards are duly made for the first year's inventions, the immediate effect of Nobel's plan cannot fail to be very far reaching. It will undoubtedly give a powerful impulse to all scientific research and experiment.

In saying this we are well aware that it has been from time immemorial one of the unspoken and unwritten boasts of the votaries of science that their rewards consist in the honor and esteem which their researches win for them—that they work for the pure love of their calling, and gladly forego the more lucrative pursuits of life. As a matter of fact it was this consideration which originally led to men's making a distinction between a profession and a trade—the old idea being that the professional man worked for his profession and the tradesman for pelf. Whatever truth there may once have been in the distinction, it has faded to a very specter of its former self in these latter days.

And yet it must be confessed that if wealth and all that it can bring is due to any one set of men more than another, it is due to the scientists, who give us from time to time those great fundamental truths upon which the industrial achievements of our complex modern civilization depend. Close the laboratory of the man of science and our boasted march of civilization would be brought to a full stop; and yet it is a fact that the great majority of these pioneers who unlock to the world the great truths upon which the industrial and much of the social fabric of our modern life is built up, reap practically nothing of the harvest of wealth for which they have done the sowing.

To such men in particular, and to that class of inventors which has the genius for discovery but no faculty to transmute its ideas into wealth, the bequest

of Nobel will come as a richly merited but too long delayed reward.

TWO HUNDRED MILES ON A BICYCLE IN ONE DAY.*

New York to Philadelphia and back, a distance of two hundred miles, in 21 hours and 54 minutes, does not look so formidable a feat in retrospect as it did when a few days ago the writer lit his lamp and said good-bye to the night clerk of the Astor House, New York, at 1:50 A. M. and took the two o'clock ferry to Jersey City. That the journey was made with comfort and with never at any time sufficient fatigue to spoil the real pleasure of the trip is to be attributed to a good constitution, careful judgment as to speed, which varied from eight miles an hour to twenty, according to the road, and last, and above all, to the perfection of that mechanical marvel of the last decade of this century—the pneumatic bicycle.

Undoubtedly it is the pneumatic tire above everything else that has doubled the distance which can be covered on the bicycle for a given amount of fatigue, and in this respect it holds the same relation to the solid rubber tire that this did to the iron tire of the primitive bone shaker. The writer speaks from experience, and as he wheeled his "safety" aboard the New York ferry at 11:30 the same night, his mind ran back to his first mount of twenty-two years ago—a veritable wood rimmed, iron tired, 70 pound "bone shaker" of the late 70's. And just here, be it said, no subsequent century or double century run has afforded the supreme satisfaction that was felt at the close of the first long run—forty miles—on this cumbersome compound of buggy wheels and bar iron. The next machine, purchased in 1876, had a larger front wheel, forty-two inches in diameter, and the iron tires were replaced by strips of half round rubber, which were tacked to the rims. Then followed the "spider" or "tension" wheel, and the bone shaker gave place to a fifty-two inch roadster, built by the Coventry Machinist Company, England. On this, in 1881, during a fortnight's tour, the writer made a run of one hundred and sixty miles in one day. That was sixteen years ago, and it was as much as anything else to test the relative merits of the "ordinary" and the "safety" types that the present two hundred mile trip was undertaken. The one hundred and sixty mile journey was made on faultless macadam roads and at a time when the writer was probably more vigorous than he is in his fortieth year; and moreover, in the present ride, only eighty-eight of the two hundred miles of road could be called really first class. Altogether, the capacity—if we might use the term—of the pneumatic, as compared with the ordinary bicycle, for touring, is probably about as two to one, and it is the pneumatic tire, and in a lesser degree the higher gear, that have made the difference.

The start from Jersey City was made at 2:20, and the first stretch of the journey to the further side of Newark was about as excruciating a piece of riding, taken as it was in the dark, as can be found in all America. The course leads across the Jersey meadows by way of the "plank road," over which the riding is only a trifle less rough than over the mile of cobble stones by which it is approached, or the three miles of rough Belgian blocks which extend from the plank road through Newark. On the further side of Newark the macadam is reached. It has taken an hour and twenty minutes to jolt this ten miles by lamplight, and the nervous irritation has already taken some of the fine edge off one's condition. But with the macadam road comes the first peep of day, and taking to the side path, the five miles to Elizabeth are reeled off at a swinging gait—but somewhat warily, for it is yet dusk. Another mile of stone paving through Elizabeth and at last, on turning sharp to the right, the swift, easy stroke of our eighty-four gear announces that one is on the truly magnificent twenty-three mile stretch of macadam from Elizabeth to New Brunswick. Here a gait is struck that varies from seventeen to twenty miles an hour, and for the next one and one-half hours the miles are reeled off over an undulating road that runs through the pretty villages of Roselle, Cranford and Westfield and through Plainfield and Metuchen to New Brunswick. This is the very beau ideal of cycling, and at this speed the cool, early morning air goes singing by in a way that makes one think there must be a brisk head wind to contend with. But the smoke wreathing lazily upward from the cottage chimneys shows that the air is perfectly still. At a quarter to six we are crossing the stone bridge over the Raritan River into New Brunswick and bumping over our enemy the stone pavement.

The clay road from New Brunswick to Kingston—15 miles—makes one painfully aware that he has left the macadam behind, and the wheel is turned from road to side path and from side path to road in search of the most eligible track. Much of this road is rocky, especially between Franklin Park and Kingston. Here we are on historic ground, for it was over this very route that Washington made his famous counter-march from Trenton to New Brunswick—a piece of

* Notes of a journey a wheel recently made by one of the editors of the SCIENTIFIC AMERICAN.

skillful strategy that marked the turning point in the War of Independence.

As one picks his way down the rocky hill into Kingston, the first glimpse is had of "the distant towers, the antique spires," of picturesque and historic Princeton, crowning the opposite hill and forming, with the dense massing of its ancient trees and the far perspective of the rich valley beyond, one of the choicest landscapes that the writer has seen in either hemisphere. Princeton, 54 miles from the starting place, is to be the first checking point, and as mine host of the inn is yet abed, the local night watch signs the Century Road Club certificate, and attests that this much of the journey had been completed at 7:20 in the morning. A cold bath, a rough crash towel, poached eggs and tea—the last our invariable beverage on a long trip—consume forty-five minutes, and shortly after 8 A. M. the wheel is once more humming its merry tune over the crisp surface of new macadam. The twelve and a half miles to Trenton are made in forty minutes; this is followed by some heavy jolting over rough pavement through Warren Street, and a ride across the broad expanse of the Delaware, by way of the combined railroad and highway bridge.

One is now in Pennsylvania, and it is good-bye to fast riding and the careless, swinging gait of the past twelve miles. The roads proper are rough, sandy and positively unridable; but the wheelmen have worn out a good side path through Bristol to Torresdale, a distance of sixteen miles. And here let it be said that however good its surface may be, there is more nervous strain and therefore more exhaustion in following a given distance of crowded side path twelve or eighteen inches wide than in riding twice the distance on a broad thoroughfare. On this run there are fifty-eight miles of such riding, and usually there is but one path. This necessitated a slow-up for every wheel that was met, and to the risk of collision was added the effort of repeated acceleration. From Torresdale to Frankfort, eight miles, the road is macadam, modified—greatly modified—by recently laid car tracks, and from Frankfort, by turning to the right at Rising Sun Lane, the celebrated Broad Street is easily found. And here at the far end of its long vista one sees, yet several miles away, the towering mass of the City Hall, crowned with its giant statue of William Penn. It is a glorious finish to the century run, this four or five mile spin over the asphalt of a great city thoroughfare, gay as it is with the bright costumes and glittering machines of a thousand wheelmen. Broad Street is a truly noble thoroughfare, and I could recall only two others that had impressed me as being more grand and spacious; those were Pennsylvania Avenue, Washington, and Collins Street, Melbourne. The latter is the pride of Australasia, and probably the finest thoroughfare of its kind in the world.

The stamp of the Hotel Lafayette was placed on the checking sheet at 11:36, and the next hour and a half was divided between a cold bath, a moderate lunch of steak and boiled rice, and a lounge. At one P. M. one was in the saddle again, and on turning into Broad Street the first genuine disappointment of the day was realized in the fact that the fresh summer breeze which had blown on the side on the outward journey had turned to the north and was now well ahead. This, with an 84 gear to push, meant a careful husbanding of strength, and the original intention of making faster time on the return trip was abandoned. Trenton was passed at 4 P. M., and 5:10 P. M. found the cold bath and the crash towel again in requisition at Princeton. This was followed by the regulation meal of brown bread, poached eggs and tea, and at six P. M. one was again speeding by the classic lawn and shade trees of Princeton University. In another hour and a quarter the spires of New Brunswick were peeping above the distant trees, and a few minutes later the wheel was humming its merry tune over the welcome macadam of the famous Elizabeth turnpike. The sun was westering, and with its decline the wind had died down. The invigoration that always comes with the cool evening air on an all day ride such as this was upon us, and home and a soft couch were again within reach. The glorious twelve mile stretch to Plainfield was swept over at just a twenty mile an hour gait, and here a dismount was made to light up for the concluding twenty-six miles to New York. It was intensely dark, and speed was slackened accordingly. The only memorable portion of this concluding stretch was the nerve-tormenting Belgian block, cobble stone and plank road jolt and jar through Newark and the Jersey meadows. The Astor House at City Hall Park, New York, was reached at a quarter to twelve, where our ally, the cold bath and crash towel, prepared the way for surely the most sweet sleep that ever fell upon weary eyelids.

The only after effect noticeable on the next day was a numbness of the hands, due to the vibration of so much riding over Belgian blocks; otherwise the trip will be remembered principally as a successive panorama of lovely country scenes. That the trip was made without fatigue was due to careful diet for a couple of months previous and judicious husbanding of strength on the trip. For the guidance of all

tourists who like to travel far afield in a limited vacation, the writer has this to say: Vary the speed entirely according to the road, riding easily when the road is trying, and briskly when it is favorable, and do not—unless you feel that you must—try to ride two hundred miles in a day.

In conclusion, the writer would advise all wheelmen who may not be accustomed to vigorous exercise to preface a century run or an extended country tour with a little preliminary training. In the present case this amounted to little more than living up to simple hygienic rules for a few weeks before the journey, as follows: Rise at six A. M., drink juice of half a lemon in water; cold sponge bath; two or three mile ride on wheel at a lazy gait; breakfast of shredded wheat and milk, poached eggs, brown bread and tea; for lunch, steak (no potatoes), brown bread and cooked fruit, stewed rhubarb preferred; for dinner, roast beef or mutton, vegetables (no potatoes), brown bread, cooked fruit and tea. Half an hour later a fifteen or twenty mile spin, starting quietly but coming home at a good gait. Then a rub down followed by cold sponge bath and bed not later than ten P. M. On the road the diet was just the same, supplemented by an occasional raw egg and sherry (the latter carried in small flask in tool bag) at any convenient roadside house or farm. Do not drink on the road, and you will not be troubled with thirst.

A NEW LIBRARIAN OF CONGRESS.

It is reported that President McKinley has decided to appoint Mr. John Russell Young, of Philadelphia, to be librarian of the new Congressional Library. Mr. Spofford, the present librarian, in a letter addressed to the President, declined to be considered in connection with the more responsible and laborious position of librarian of the new library, on account of advanced years. Under the act passed by the last Congress the reorganization of the library will be made on July 1, and Mr. Young will assume the duties of librarian immediately upon confirmation by the Senate. The salary of the librarian will be \$5,000 per annum, and he will have the appointment of the assistant librarian, who will receive a salary of \$4,000. It is understood that Mr. Young will tender this place to Mr. Spofford, and that the latter will continue to give his services to the library, with which he has been connected for thirty-five years. Provision is also made under the new law for a superintendent of the new library building, at \$4,000. This place has been given to Mr. Bernard R. Green, who has rendered such efficient service during the construction of the new library building. There is also to be a superintendent of copyrights, with a salary of \$3,000. It is satisfactory to note that the government has at last seen the fallacy of attempting to link a learned profession like that of a librarian with a clerkship.

Mr. Young, who is a lifelong friend of Mr. Spofford, was born in 1841 at Downingtown, Pa. He was educated at grammar and high school, and began his newspaper career at the age of sixteen years. He acted as war correspondent during the greater part of the civil war. He held important positions on the Philadelphia Press, the New York Tribune and the New York Herald, and during his residence in London, while having charge of the foreign news service of the Herald, in 1877, Mr. Young was invited by Gen. Grant to accompany him on his famous tour around the world. Mr. Young wrote many brilliant articles describing the scenes and incidents of the tour and afterward recast and published them under the title of "Around the World with General Grant." He returned to New York in 1879, and occupied a position on the editorial staff of the Herald, which he retained until his appointment as minister to China. He returned to the United States in 1885, and since that time he has been connected with the Evening Star, of Philadelphia.

NEW RAPID HARBOR MAIL SERVICE.

The plan of discharging the foreign mails from steamers while waiting at quarantine, to a harbor steamboat, specially provided with facilities for sorting the mail, went into effect in New York Harbor for the first time on July 1, 1897, and worked very successfully.

The mails were placed in bags for western and eastern cities while on the steamboat and delivered at the Battery, Jersey City, and near the foot of West Forty-second Street, from whence they went forward without delay by the first trains to the respective western and eastern sections of the country.

It is expected that from ten to twenty-four hours time will be saved by this arrangement, while the general post office in this city will be saved much additional work.

At Chita, the chief town of the transbaikal district of Siberia, a museum has been established already. It contains rich collections relating to Buryate Buddhism, as well as objects belonging to natural science, archæology, and mining. The museum has a little botanical garden annexed.

LOTTERY INDUCED PATENTS.

Our attention has been called to the methods of an Eastern patent firm who, in order to increase their business, are offering money prizes for inventions considered and pronounced as most meritorious by a board of awards operating in connection with the firm. "The offer of such a prize," writes a well known patent attorney, "serves as a bait for the unsuspecting inventor, inviting him to spend his money in a lottery scheme, the fruits of which are far more disappointing and disastrous than were those of the Louisiana Lottery, now prohibited by law. The only prize which a reputable attorney can offer is superior work, the earnest application of his energies to the securing of claims commensurate with the merits of invention, and the obtaining of patents which will stand the scrutiny of skilled attorneys, and pass muster in a court in which they may be the subject of adjudication. Such a prize makes one's patent reward one for one's inventive genius, as it is only a good patent that can be disposed of with profit. The legitimate reward of genius is not a prize in a lottery scheme, nor is it a silver medal worn or carried about the person; but it is the solid cash which a patent with well drawn claims will realize for the inventor."

The evils of this "lottery prize" process of working inventors are so glaring that Congress will probably abate the whole scheme during the present session. Senate bill 1057, introduced by Senator Hansbrough, March 22 last, aims at this result. It provides: "That hereafter it shall be unlawful for any person or persons, firm or corporation, engaged in procuring and prosecuting patent claims to offer or award to their business correspondents or clients any gift, prize, or chance to win one, medal of honor, certificate of stock, or any other article or thing of real or supposed value, intrinsic or otherwise; and any person or persons violating the provisions of this act shall be deemed guilty of a misdemeanor, and on conviction thereof shall for each offense be punished by a fine of not less than five hundred dollars, and not more than one thousand dollars, or by imprisonment at hard labor for not less than six months nor more than one year." Other sections of the bill provide for the proper enforcement of section 1, as given above.—The Age of Steel.

DEATH OF PROFESSOR DE VOLSON WOOD.

Prof. De Volson Wood, of the chair of mathematics of the Stevens Institute of Technology, Hoboken, N. J., died June 27, aged 65. He graduated from the Albany Normal School in 1853, and two years later from the Rensselaer Polytechnic Institute, Troy. He was appointed professor of civil engineering at the University of Michigan the same year, which place he held for fifteen years. He then received a call to the chair of mathematics at Stevens Institute, and later to the chair of mechanical engineering. He was a member of the American Society of Civil Engineers, the American Society of Mechanical Engineers and of the American Association for the Advancement of Science. He was the first president of the Society for the Promotion of Engineering. He was the author of many text books on mechanical engineering.

ELECTRIC LIGHT AND SAILORS' EYESIGHT.

Owing to the intensity of the electric light used on board of men-of-war, men are frequently affected with eye complaints, which in some cases have led to total blindness. It has been observed that eyes in which the iris is not heavily charged with pigments, that is to say, gray and blue eyes, are more likely to be injuriously affected than brown eyes. These eye troubles are ascribed to two causes, viz., the intensity of the light and the action of the ultra-violet rays. Oculists recommend the interposition between the eye and any powerful light of a transparent substance which will intercept the ultra-violet rays, such as, for instance, uranium glass, which is yellow. The French naval authorities supply dark blue glasses for the use of those men who have to do with search lights, etc., and the cases in which injury has been caused to the eyes were those of men who had neglected to use these spectacles, which, however, do not appear to afford any protection against the ultra-violet rays.—Revue du Cercle Militaire.

DEEPENING THE ST. LAWRENCE.

The Dominion government proposes to complete the deepening of the St. Lawrence River from Quebec to Montreal this season. Already about \$3,500,000 has been expended to make the 160 miles of river of a depth of 27½ feet. It will require \$500,000 more to finish the work, and that sum has been voted to the Minister of Public Works for the purpose.

The government also proposes to construct three new wharves at the center of Montreal harbor. The Minister of Public Works says that Montreal harbor is in a poor condition for shipping, and he proposes to take immediate steps to remedy it. After the close of Parliament he will visit Belgium and Germany with an engineer to inspect the harbors in those countries, in order to devise the best plan for the improvement of Montreal harbor.

A SPECIAL BRAZER FOR BICYCLE WORK.

In bicycle manufacturing and repairing an efficient portable brazer is a necessity, and we herewith illustrate such a brazer, adapted to generate a very high degree of heat, and so easily managed as to make of the work of brazing only a light, clean task, which one

**THE STRAIGHT-TURNER GASOLINE BRAZER.**

may carry on without soiling the clothes. It is manufactured by the Turner Brass Works, No. 122 Kinzie Street, Chicago. The head is equipped with firebrick, which increases and retains the heat, and the burners may be turned low, like a lamp, when not in use, a single turn of the valves bringing on the full blast. The tank is made of boiler steel, galvanized, and tested to 150 pounds. It should be filled not more than three-quarters full of 74° stove gasoline, the air pump connected, and a pressure of 25 to 50 pounds obtained, when commencing work. The flame is readily adjustable to the desired size by means of the valves at the sides, the flames being preferably balanced so that they will meet squarely over the tee in the center of the head. This brazer is used by many of the prominent bicycle manufacturers, and, in addition to its high efficiency, is said to be very economical in its consumption of gasoline. The burners may be easily cleaned, should they become clogged by impurities in the gasoline.

A PUNCTURE PROOF BICYCLE TIRE.

The accompanying illustration represents a tire which, while practically solid, is designed to have all the resiliency of an ordinary pneumatic tire, being at the same time puncture proof. It has been patented by Franz A. Hamp, of 210 East Pearl Street, Cincinnati, Ohio. One of the figures shows the tire partly in section, while the other represents it with the exterior tube, which is preferably made of rubber, partly removed. As will be seen, the body of the tire is formed of sections of cork fitted together to form a perfect ring around the rim, the sections being held connected by a

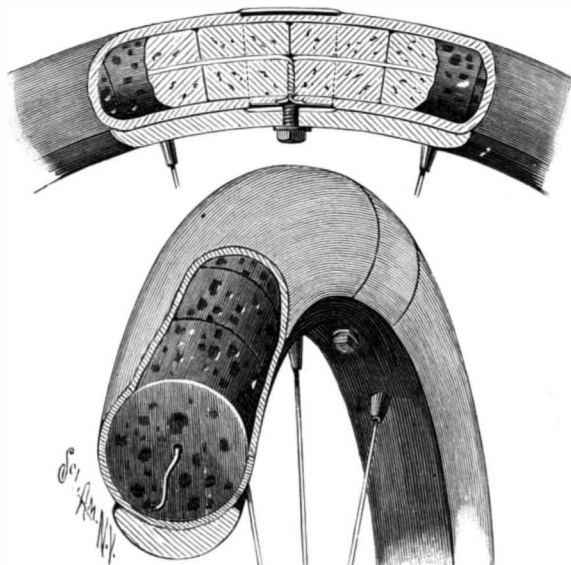
**HAMP'S BICYCLE TIRE.**

central wire whose ends are twisted together and carried in opposite directions. The ends of the casing tube are preferably brought together at the point where the tie is secured, and here, as shown in both views, a metal sleeve, also rubber covered, is tightly fitted around the tire, there being preferably two of these sleeves embracing the tire at opposite points in its circumference. The outer section or casing of the

tire need not necessarily have two ends, but the casing may be filled by means of an opening on the inner side. The tire is cemented upon the rim, through which and through each sleeve is passed a set screw, one of the screws engaging the extremities of the twisted wire. The inventor has constructed machinery for preparing the cork, which it is designed to subject to hydraulic pressure and impregnate with a fluid to enable it to maintain its elasticity.

An Old Nail in Old Wood.

English papers report that, while a workman was recently sawing a beam taken from the roof of Winchester Cathedral, a nail $2\frac{1}{4}$ inches long was discovered in the middle of the piece about 9 inches from the surface. The conclusion drawn from a nail in that position is that it was driven into the young oak and that, before the tree was cut down, the wood had grown around the nail, that process likely occupying a couple of centuries. It is assumed that the beam was introduced in the course of the reparation of Winchester Cathedral, which was undertaken by Bishop Walkelyn and carried out between 1079 and 1093, but it should be remembered that some of his successors had works executed up to the end of the fourteenth century, when William of Wykeham commenced his restoration. It is thought that in any event the nail must have remained concealed for nearly 1,000 years.

AN IMPROVED BULLET LUBRICATOR.

To properly lubricate bullets before they are placed in cartridges, the device shown in the illustration has been patented by William W. Tracy, of Pittsfield, Mass. The bullets are formed with the usual annular recesses adapted to receive grease in a plastic state, and are placed, as shown in the principal figure, in bores arranged in a circle in a disklike head whose interior has a series of radially arranged channels communicating with an annular chamber into which all the bores open, as represented in the sectional view. The head is centrally connected with the barrel of a pump, the plunger of which is actuated by a handle to press the lubricant down and outward through the channels into the annular chamber, and thence to the bores and into the depressed recesses or channels around the bullets. The entire number of bullets in the bores is thus simultaneously lubricated. The bores are designed to fit the bullets closely above and below the sections in which the annular recesses are formed, so that no lubricant can escape by way of the bore.

**TRACY'S BULLET LUBRICATOR.**

THE American Druggist suggests the following remedy for the annoying mosquito: Take some powdered pyrethrum (Dalmatian flowers), moisten and mix into a paste, mould the stuff into conical lumps as big as chocolate drops, and bake in an oven. "When fired at the point," says the journal just referred to, "such a cone will smoulder slowly and send up a thin column of pungent smoke, not hurtful to man, but stupefying to mosquitoes. In actual experience two or three such cones burned during the course of an evening have given much relief from mosquitoes in sitting rooms."

A NOVEL PLANT PROTECTOR.

An improved device for insuring the rapid outdoor growth of plants early in the season, without the use of hothouses or hotbeds, is represented in the accompanying illustration and has been patented by Samuel Taylor, of Winters, Cal., and Joseph Gardam. It consists principally of a glass hood, with a funnel opening at the top adapted to be opened and closed by a valve controlled by a thermostatic spring actuated by the heat of the surrounding atmosphere. The valve has a stem fulcrumed on a bracket, to the outer end of which one end of the spring is attached, and near the free end of the spring is a lug in which is a slot adapted to engage a pin on an extension of the valve stem. The contraction and expansion of the spring with the variations of temperature cause the lug to act on the pin to impart to the valve an up and down swinging motion, as indicated by the dotted lines. The bracket is itself adjustable up and down on an arm clamped to the funnel, whereby the device may be set to the degree of

heat at which the valve is desired to close the upper end of the funnel, the valve controlling both the ingress and egress of air to and from the hood. In a modified form of the device the valve is held directly on the free end of the spring, whose other end is attached to the arm clamped on the funnel. By employing this

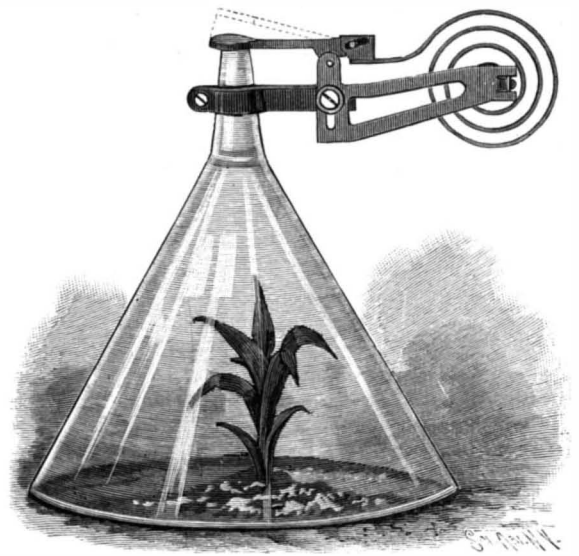
**TAYLOR'S PLANT PROTECTOR.**

device, transplanting and its incidental retarding of the growth of plants may be generally avoided.

AN EFFICIENT ELECTRIC BICYCLE LAMP.

The illustration represents a convenient, highly serviceable electric lamp for bicycles, adapted to burn for six or eight hours, which is being introduced by W. Pollack, of No. 565 Boulevard, New York City. It has two made up positive elements and two negative zinc elements, connected in series, the elements being inserted in sockets in the top of the lamp, and each held in place by a cap and screw nut, a rubber washer being placed on top of each. These appliances are also shown in the illustration. The liquid charge is preferably made of water and sulphuric acid, of which a measured quantity is supplied through the sockets provided for the positive elements. The zinc element is only about half the length of the positive element, and is thus held out of contact with the liquid when the lamp is in the position shown, the light being then extinguished, but the circuit is completed and the light established when the lamp is turned the other side up. The positive elements are furnished ready for use, wrapped up so as to take hardly the space of a small pocket knife each, and in riding it is generally best for one to carry an extra bulb and a pair of these elements. The new bulb is readily screwed in place in case one burns out or is damaged, and a new positive element is as readily inserted. It is said the cost of using these lamps constantly is only eleven cents a week. The rider need not carry any acid with him, other than that in the lamp, the renewal of a light, should it go out, being

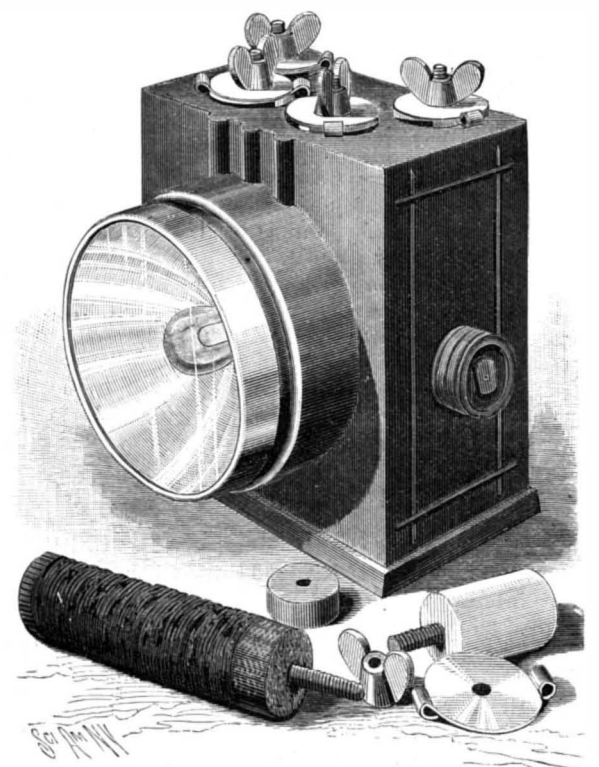

effected simply by inserting another new element. There is absolutely no local action and the lamp may be used any time within a year after charging. The lamp is readily fastened in place by a swivel clamp at the back, not shown. In addition to its use on bicycles the lamp is adapted for carriages, mining purposes, country residences and stables, night watchmen and policemen, etc.

The Origin of Medicines.

The fact that certain herbs and plants produce certain effects upon the human system, and alleviate or cure certain ills, has been known from time immemorial. Perhaps the most ancient of medicines—properly authenticated, that is—hops, which was used in the dual capacity of an intoxicating beverage and as a medicine in 2000 B. C. This is attested by pictures of the plant on Egyptian monuments of that date. Creosote was discovered in 1830 by Reichenbach, who extracted it from the tar of wood. Potassium was discovered in 1807 by Sir Humphry Davy, but alcohol was first distinguished as an elementary substance by Albucahis in the twelfth century.

Scheele discovered glycerine in 1789. Nux vomica, which is nearly as old, is the seed of a tree indigenous to India and Ceylon. Peppermint is native to Europe, and its use as a medicine dates back to the middle ages. Myrrh, which comes from Arabia and Persia, was used as medicine in the time of Solomon. Hemlock, the extract of which killed Socrates, is a native of Italy and Greece. Iodine was discovered in 1812 by Courtois, and was first employed in a hospital in London in 1825. Ipecac comes from South America, and its qualities are first mentioned in 1648 by a Spanish writer, who refers to it as a Brazilian medicine. Ergot is the product of the diseased seeds of common rye, and is one of Hahnemann's discoveries. Aconite grows in Siberia and Central Asia, and was first used as medicine by Storck in 1762. Hasheesh, or Indian hemp, is a resinous substance produced from the tops of the plant in India. It has been used, as has opium, since Indian history began. Caffeine, the active principle of coffee, was found by Runge in 1820. Ordinary coffee contains about 1 per cent, Java coffee 4½ per cent, and Martinique 6½ per cent. Arnica hails from Europe and Asia, but the medicine is made from artificial plants grown for that purpose in Germany and France.—*Pall Mall Gazette.*

A REMARKABLE PEAR TREE.

One of the most remarkable of old trained pear trees that we are acquainted with is the splendid specimen

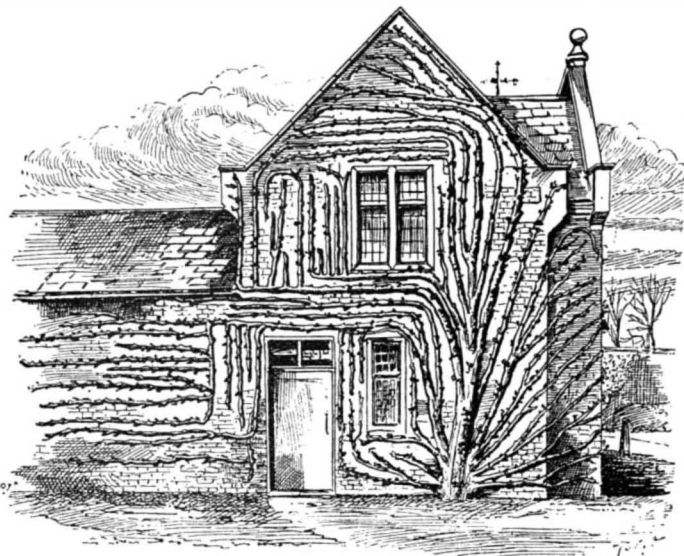

UVEDALE'S ST. GERMAIN PEAR TREE AT WESTON HOUSE—WINTER VIEW.

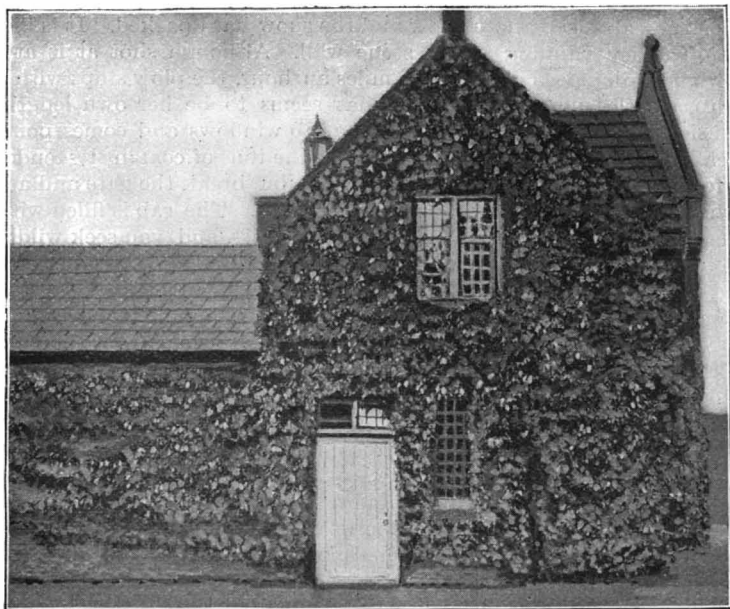

UVEDALE'S ST. GERMAIN PEAR TREE AT WESTON HOUSE—AUTUMN VIEW.

of Uvedale's St. Germain at Weston House, Shipston-on-Stour, the residence of the Countess of Camperdown. The accompanying illustrations are reproduced from photographs taken by Mr. S. Freeman, of Moreton-in-Marsh, and published in the *Gardeners' Magazine*. Mr. Masterson, the gardener at Weston House, writes that

"the tree is admired at all times of the year, but more especially when covered with large handsome clusters of flowers. In autumn, when laden with quantities of big fruits, it also presents an attractive appearance, and there are many who also admire the tree when the stems are bare, and certainly at this season it is interesting, as the training is very remarkable. The tree seldom fails to ripen a heavy crop of fruits, cropping right down to the ground. It has never been fed or root pruned, and its roots are in the bed of the carriage drive, gravel also encircling the stem at the base, where it measures six feet in circumference. It is, however, very probable that the roots have penetrated a considerable distance and come into contact with the stable drains, thus deriving the nourishment required by so large a tree. The fruits are seldom thinned, as the tree is so vigorous as to be capable of carrying very large crops, and yet the fruits weigh from half a pound to one and a half pounds each. The total weight of the crop last year was two hundredweight. Many first prizes have been won from this tree, including firsts at the Crystal Palace in 1894 and 1895."

A CARTHAGINIAN MASK.

In 1893, the Rev. A. L. Delattre, having had his attention called by an Arab to several small objects that he had discovered while making some excavations at Douimes, decided to make some researches in the vicinity. Toward the latter part of the summer of that year, having engaged some laborers and set them to work, he was soon rewarded, after excavating through six feet of soil intermixed with rubbish, by the discovery of the primitive argillaceous earth in which the Carthaginians found a last resting place for their dead.

In November, 1893, there had been discovered sixty tombs, almost all of which were placed at right angles with the seashore. The majority were simple trenches covered with slabs of tufa, the only kind of stone employed in the primitive structures of Carthage. Infiltrations had filled each trench with a fine yellow sand, the color of which was often confounded with that of the natural earth.

The funereal furnishings usually consisted of two medium sized urns with a handle on each side, of two small jugs with a single handle, of a flat bicornous lamp and its patera (a sort of saucer), and sometimes of a bronze hatchet, a hand bell, cymbals and a mirror or other objects of ornament, such as collars, rings, bracelets, earrings, painted vases, figurines, amulets, shells, etc.

One of the most interesting finds was a curious terra cotta mask, which was brought to light in the month of September, and which is illustrated herewith.

It was discovered at a new point of the Punic necropolises of Carthage, very near the site of Serapeum, in a very small space where had just been found more than twenty Carthaginian tombs, always containing funereal furnishings of the same character, save that the pottery was more highly ornamented and of finer quality.

The mask is 8 inches in height and 5 in width, and the hollow part 3½ inches in depth. This grotesque face, with low and narrow forehead, projecting eyebrows, wide and flat nose, and angular cheeks and crooked mouth, preserves a few traces of black paint. The mouth and eyes are cut out through the thickness of the clay and the ears are ornamented with rings. Around the mask are distributed five holes—one at the top, and one beneath and one above each ear. These holes certainly served for fixing the mask in place. There is nothing Egyptian nor Greek about the style of the work, and the specimen seems to be an authentic one of local art. In fact, at the base of the forehead and at the origin of the nose, it bears the mark of its Punic origin in the crescent surmounting the disk, which it embraces with its depressed horns—an emblem that is very frequent upon the votive stelæ of Carthage, and which we often find engraved upon the bezel of rings or arranged so as to be strung and worn as an amulet.

One peculiarity that this mask exhibits is that it changes physiognomy according as it is viewed in profile, at an angle, or full face.

This mask constitutes a true caricature. Contrary to the opinion held up to recent years, the Carthaginians must have practiced the art of portrait taking. Prof.

Duhn, in an article recently published at Berlin, observes that several Punic masks in the Saint Louis Museum remind us of Japanese rather than of Mediterranean art, on account of the extraordinary naturalism exhibited therein, and that makes true portraits thereof. Such is the first impression, but a profounder

study of these interesting pieces permits us to recognize an entirely archaic art in them. The mask under consideration is less than natural size and consequently could not have been applied to the face of a corpse; neither was it suspended in the tomb. Notwithstanding the holes with which they are provided, these sorts of masks, as well as the clay statuettes that are found

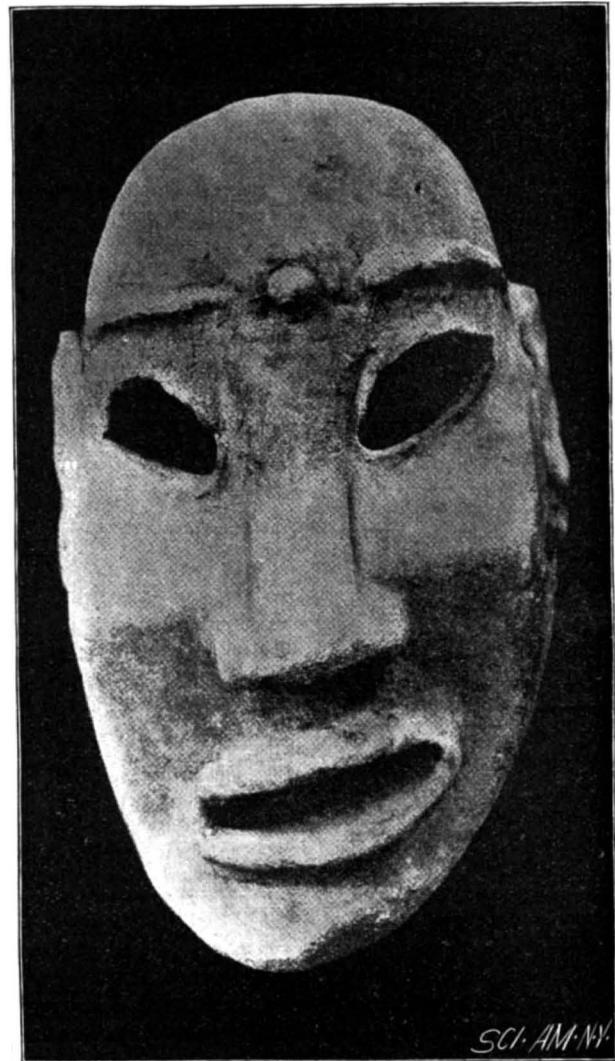

A CARTHAGINIAN MASK.

in the necropolis, were simply placed alongside of the dead. The object of the relatives or friends who inclosed these objects in the tomb was merely to know that the body of the defunct was accompanied with an object to which they attributed a magic virtue capable of protecting the mortal remains in their final dwelling.

Such masks have been discovered in the most ancient necropolises of Sardinia. The Cagliari Museum possesses several of them.

For our engraving and the above particulars, we are indebted to Cosmos.

Caution to Middle-aged Bicyclists.

Any form of exercise or sport which makes serious demands on the attention, on quickness of eye and hand, and on endurance, ought not to be taken up by people who have reached middle life and are engaged in sedentary occupations, only with great circumspection. The lesson has been learned by Alpine climbers though many bitter experiences. It is pretty generally held by them that most of the fatal accidents in mountain climbing occur through the failure at the critical moment of some man who has taken to mountaineering too late in life, and who is, perhaps, also out of condition. An old dog cannot be taught tricks, according to the proverb; and though it is disagreeable to have to realize that we have passed the age when we can excel in a new pastime requiring special skill to avoid accidents, and youthful adaptability and elasticity to avoid overstrain, it is the part of wisdom to accept the inevitable. There is no reason why middle-aged men, and even those who have passed middle age, should not take to cycling; but it should be with a frank recognition of the limitations which age imposes. Great speed, long distances, and hill climbing put a strain upon the constitution, and will find out the weak places, the parts of the system which are aging faster, perhaps, than the rest—the heart, it may be, or the vessels of the brain. So, also, in regard to riding a bicycle in crowded thoroughfares, the strain on the attention is considerable and the risk not small, if a man has lost the quickness of youth.—*British Medical Journal.*

It is said that F. W. Christian has returned to Sydney after two years spent in exploration in the South Sea Islands. The details are very meager as yet. It is stated that he discovered ancient records, weapons, etc., which prove that the Asiatic races traded in the islands.

FIGHTING SNOW ON THE RAILROADS OF THE NORTHWEST.

The past winter proved to be the most trying in the history of the railroads of Dakota and Minnesota, both in respect of the enormous quantity of snow that fell at any given time and the unprecedented length and frequency of the storms. Those of our readers who live east of the Mississippi have but a faint idea of the heroic struggle which is made during a winter of heavy snows to keep open the railroads between the various cities, and maintain the lines of communication between East and West by way of the great transcontinental railroads.

We have received from Mr. E. W. Hadley, of Santa Barbara, California, a graphic description of his former experiences when, as division superintendent, he was "fighting snow" on one of the great Western railroads. The accompanying illustrations are reproduced from photographs taken by Mr. H. Steinhauer, of Groton, South Dakota, after the great blizzards of last winter. Mr. Hadley writes as follows:

The Dakotas, Minnesota and northern Iowa are the haunts of the blizzard and the home of the Storm King. The windswept prairies of Nebraska and Kansas, level as a billiard table, while trying enough in midwinter, do not possess the essentials of a great snow country. The general contour of Dakota and Minnesota is rolling—sufficiently so that on many of the railroad lines cut succeeds cut, with an average, on many of the worst portions, of ten to the mile. For a long term of years the writer, as division superintendent, presided over the destinies of the "chain gang" on several hundred miles of the Dakota and Minnesota lines of one of the largest Western railroads, spending some six or seven months out of the twelve in a ceaseless battle with snow. I do not think I can give a better idea of this species of war—for it is nothing less—than by describing a snow bucking expedition in the midst of the winter campaign. Like "the days of old, the days of gold, the days of '49," these days will come no more. The advent of the "rotary" has robbed the blizzard of its dangers and has added many thousand dollars to the capitalized valuation of the Northwestern lines.

Winter commences in the far Northwest in September, and with no uncertain sound. The writer has seen water pipes within the brick walls of a steam heated building frozen solid on the twenty-fifth day of September, and was unable to lay up his snow plows until past the middle of the following May. The latter end of summer in the shops and roundhouses at division points is devoted to putting in trim the snow fighting outfit. Engines are overhauled, plows buckled on, "flangers" and "white wings" got ready; the lists of engineers and conductors are carefully scrutinized and those of most experience, or better fitted for the service, told off to run plows and "drag-outs." Let us skip the opening skirmish, however, and get into the thick of the fight. The superintendent surveys the yards from the watch tower of his office, and listens with a sense of its restful hum to the ceaseless click of the instruments in the next room. The connecting door opens, the chief dispatcher looks in long enough to say that Mandan or Medicine Hat has just reported a blizzard coming up. Now Medicine Hat is the weather-maker of the Northwest. The genuine blizzard is born there and comes thence a thousand miles to pile up the snow on your own particular track.

Again the door opens and the watchful dispatcher announces that "Medicine Hat says blizzard getting worse." Without, everything is brilliant sunshine and trains are all on time, but the cautious superintendent goes to the phone, calls up the roundhouse, and tells the foreman that he had better "put a fire in 321 and a couple of the lighter plows." A few hours pass—a subtle change comes over the weather—the sun doesn't seem to shine quite so brightly—there is a trifle of haze in the air. Suddenly there is a quick change of scene. The sky grows dark and leaden colored in the northwest; the thermometer drops a few degrees and there is a trace of fine snow in the air. The last act comes on quickly; with a rush comes the howling wind out of the Northwest, filled with fine snow, and where, but a few hours before, the sun was shining the blizzard now rages in full force. The wind is a hurricane of forty miles an hour, and the air is so full of snow that it is impossible to see the length of a telegraph pole. Now all is hurry—the superintendent takes up his quarters in the telegraph office, and together he and the dispatcher watch the progress of the few trains still out upon the road and devise measures to get them under cover. No. 1, the night express, which left the southern terminus of the line several hours before, has run into the blizzard and is making slow progress. She left Colgate a full hour ago, but has not yet shown up at Pinto, the first station north, although her running time between the two is about twenty minutes. Pinto here calls up the dispatcher and ticks off a message from the conductor of No. 1, who has just walked in, announcing that his engine blew out a cylinder head three miles south of Pinto—that she is short of water, and that he has "killed her." In swift succession orders are sent to hold at terminal points two branch line passenger trains now due to leave, and an order is

sent to Hooker, and engineer of plow engine 119, which has been held in reserve at Fairmount, to run to Pinto, and flag from there to where No. 1 is stalled and try to get her out. The chances of getting out No. 1 before midnight look very slim, and the conductor of No. 1 is instructed to hire any available sleighs at Pinto, load them with fuel and provisions, and get back to his train. This order had hardly been got off the line before the wire goes down and all communication is shut off. Now comes a period of forced inaction which grows many a gray hair in the superintendent's head. What of the two hundred or more passengers on No. 1—the women and children out on the trackless prairie exposed to the full force of the blizzard? What of the carloads of cattle and horses on the first section of No. 17?

There is nothing to be done in the way of sending out additional plows, however, until the blizzard shall have blown itself out, but the superintendent finds a vent for his activity in preparing for the coming fight. Getting on his buffalo overcoat and snow boots, he visits the roundhouse to see that everything is in perfect readiness for an attack on the snow as soon as the blizzard shall have let up. He sees that plow engines are abundantly supplied with oil, tallow, waste and steam hose—that water cars are cleared of ice and filled, and that a couple of box cars equipped with stoves, tables and chairs are loaded with provisions. Engine and train crews are notified to keep within instant call, and messengers are dispatched to gather an army of snow shovelers. Toward morning of the third day the superintendent is awakened by the caller, who hands him a message from the night dispatcher advising him that the blizzard shows signs of dying down. It is welcome news, and a few minutes more finds him at his office ready for the start. The dispatcher has not been idle, and by the time the blizzard shows signs of dying down the yard is full of snow equipment. Two heavy freight engines, each carrying heavy iron plows, stand coupled to cabooses ready to be launched against the drifts on two branch lines. The outfit for the main line is a more ponderous one. An immense Congdon plow, faced with wood and shod with steel, is backed up by two 17 by 24 engines, the pilot having been removed from the rear one so that it may be coupled up close. The face of this huge plow rises almost to the top of the engine stack, and in order that some view ahead may be obtained, a small cupola has been built upon top of the engine cab in which the conductor may ensconce himself and thus be enabled to direct the engineer. On the main track, a few rods behind this immense plow, stands the drag-out, a 19 by 26 ten-wheeler, coupled to which is a train made up of three or four coaches, the cooking and provision cars before referred to, a water car, a coal car, and the conductor's caboose. The coaches are filled with a crew of two hundred navvies equipped with shovels and scoops.

The wind has now almost completely gone down and the thermometer has fallen to thirty-five below. All of the men moving around wear shaggy fur overcoats, fur caps and felt boots an inch thick. Nothing but the matted hair of the buffalo, a native of these barren prairies, will withstand this intense cold. The gray dawn comes on apace, and with it comes the conductor of the plows with the yellow copies of his orders fluttering in his hand. He climbs aboard. There is a shrill blast of the whistle, repeated by the second engine, and the plow is off. If you are now in the cab of the forward plow engine, climb up on the fireman's side, brace your feet against the front end of the cab and the fireman will hand you a small piece of greasy waste. You can keep the frost off the window and gain a glimpse ahead. The engineer opens her up a little and we strike a thirty mile gait. Nothing in sight but the boundless prairie looking like a frozen sea.

And now the engineer, without waiting for an admonition from the conductor, slows down, for he knows that he is close upon a long curving cut that should be full of snow. Running up close to the beginning of the cut, he makes a full stop, and conductor, superintendent and roadmaster unbuckle the snow curtains, get out and walk ahead to have a look at it. A peculiarity of drifts in these high latitudes is the solidity with which the tremendous wind pressure packs the snow. The crystals are small and angular, like meal, and the driving wind presses and fits them together with a solidity that is but little short of ice.

The long, shallow approach to the cut is the most dangerous part of it, for there the snow is sure to be hardest and the depth is not sufficient to insure the plow staying on the track. While there are a hundred dangerous chances in bucking snow anywhere, good judgment demands that they should be minimized as far as possible, and the roadmaster is therefore sent back on the run to hustle out his force. Getting within hailing distance of the drag-out, which has now come up, his stentorian voice and waving arms quickly bring to the front a force of husky snow shovelers, whom, with the tact of a general disposing his forces, he soon has scattered over the snow drift, some shoveling away the shallow snow and putting a "face" on it, as it is called, other parties cutting trenches across the

drift in its deepest parts. The drag-out is now ordered back out of the way and the plow gets back a few miles in order to gather momentum for a run. In all these operations time is at a heavy premium, for every hour that the road is blockaded means a heavy financial loss. Standing upon the highest point of the drift, the burly roadmaster urges on the efforts of his men with hoarse shouts and commands.

Away from the distance comes the piercing whistle of the eager plow, announcing that she is ready. The roadmaster gives a final glance at the face of the cut to see that it is properly undercut so as to hold down the nose of the plow, then climbs to the highest spot and signals that he is ready. Now, if you are perched on the fireman's seat, you begin to get a realizing sense of the delights of flight. The throttle is wide open and the engineer is giving her notch after notch. If you are an old hand at the business every consideration of fear is swallowed up in the intense excitement of the mad rush; but if you have never ridden behind the plow before, there comes over you a sickening sense of utter helplessness and a strong realization of the grim nature of the work. But sixty or seventy miles an hour quickly cover the few miles of race track, you catch a glimpse for a second of the lines of navvies on either side of the cut and then plunge into complete darkness! You feel as if you had dropped into deep water; the engineer throws her forward into the company's notch, and with almost human struggles and efforts you feel the tremendous machine pushing her way through the snow. As she strikes trench after trench, the wheels take a fresh hold upon the clear rail and the plow plunges forward a few feet further; but at last, with a final whirl of the drive wheels, you come to a full stop. The engineer pushes back the sliding sash on the side of the cab, and with a gasp of relief you find that you are about on a level with the top of the drift, and crawl out of the window to find the plow almost completely buried in snow. The drag-out has followed up close behind, and the roadmaster has every available man hard at work digging away from around and behind the plow.

Now the ponderous ten-wheeler is brought up, and proceeds by main force to drag the plow out of the drift. Hardly does she clear the cut before the shovelers are driven thick into it to put a new face upon the drift and carefully clear the rails leading up to it, ready for new run. Back again toward the horizon, this time to a distance of five or six miles, goes the plow. This time you watch her as she comes out of the distance like a black speck, growing rapidly in size, and as she picks up a few shovelers of snow, throwing it off the plow in graceful curving rainbows. With a hoarse scream she dashes into the cut, and for an instant it appears as if a mine had been exploded under the drift. The snow is at first thrown high in air, but as she loses speed, it is rolled out of the cut in immense masses weighing tons. For an instant it looks as if she would be stuck again, but the drift has been skillfully trenched, and with the renewed impetus gained from a few feet of clear rail, she dashes through the diminishing drift, and with a growing feeling of confidence you start ahead for the next struggle.

The next serious cut is four hundred feet long, ten feet deep for some distance in the center and full of the hardest snow. It is critically examined and probed with a bar to detect any stratum of ice which might run through it, and it is decided to trust to a long and hard run to get through without spending time in trenching it. The plow is sent at it with a will. But the cut is deep and narrow and the snow hard packed. It is like running into a stone wall. Although shot at it at a speed of sixty-five miles an hour, the plow stops with a mighty shock in what seems to be her own length. The snow bursts in the cab windows and comes pouring in like an avalanche; the tons of coal in the tender can no longer be restrained, but break the gate and are hurled against the boiler head. The cab is filled with escaping steam and falling glass, and you seek wildly for some means of escape. Again the plow is dug out, the snow shoveled out of the cab, boards nailed over the windows, and the engineer, tying a handkerchief around his forehead to stop the flow of blood from the cuts made by the broken glass, sounds a retreat, but with a grim determination to "put her through this time or break a steam pipe."

And so the fight goes on day after day—it may be ten days before the line is again open to traffic. The dead engines are found and resuscitated—their crews having found a refuge in the nearest farmhouse. The passenger train is discovered completely buried in snow with a fence board stuck in the engine stack to indicate its grave. The train crew have managed to keep their passengers from starvation or freezing by drawing on the scattered farmhouses for provisions, and by using the coal from the tender of their dead engine to keep the cars warm. The broken telegraph line is found and repaired, and the superintendent's first message sets other plows at work from the southern terminus. The two outfits finally meet, and with triumphant whistles and a few brief words of congratulation, the snow bucking expedition is over.

The fight has resulted in a victory of brute strength

over the elements, and that is always a costly proceeding. Fifty dollars per mile of main track is the usual estimate for keeping the line clear of snow during the year, but of course in many instances the figure is much higher. This amount also is intended to cover merely the direct cost of removing snow, but does not by any means reach the indirect loss through damage to motive power and rolling stock, and by loss of traffic.

The narrator had just returned from a ten days' snow bucking expedition, when the first rotary which had been brought to the Northwest was turned over to him. With feet still wrapped in bandages from the effect of frost bites, he painfully climbed from the plow into a comfortable chair in the front end of the rotary, and memory still brings back the sense of complete triumph and deep satisfaction with which, from this comfortable position, he saw this "whirling wheel of fortune," as the machine was instantly dubbed by a quick-witted conductor, hurl his ancient enemy in a snowy Niagara high in air and beyond the right of way. But yet he was obliged to confess that while snow bucking, with a rotary, had lost almost all of its discomforts, it had at the same time deprived him of a source of keenest enjoyment.

The Annual Battle with Insects.
BY GEORGE ETHELBERG WALSH.

The protection of our common birds from ruthless destruction assumes a new importance in the eyes of many, now that special attention is drawn to the great economic value of these creatures by the Department of Agriculture. It is estimated that about \$100,000,000 are saved to the farmers of the country by the birds; and if this is true to-day, what must have been the case fifty years ago? We had ten song and field birds then to every one that is now in existence in this country. Insect life has been steadily multiplying in direct proportion to the slaughter of the birds; and with the disappearance of every species of birds there has come into existence new insects that help to make agriculture more uncertain and precarious.

Our birds were the appointed guardians of our crops in field, forest, and garden. Most of them depend for a living upon insects, vermin, and rodents. When Audubon stated that the woodcock would eat its weight in insects in one day, he merely called attention to the general omnivorous habit of most of our insectivorous birds. They are all great insect destroyers.

For a quarter of a century science has been laboring in the cause of agriculture to reduce the number of garden pests and to hold them in check. The annual battles with the insect foes are carried on energetically from early spring until late autumn; and the farmer or gardener is never quite sure of his crops until they have been actually harvested. In spite of all the protective agencies that science has surrounded the fields and gardens with, disasters of gigantic proportions will break out occasionally through the sudden growth of some species of obnoxious insect or fungous growth.

It is the destruction of the potato crop one season by the Colorado beetle; the total failure of the wheat yield in certain States by the rust or blight another year; or the widespread injury to the cotton plants by the boll worms. Somewhere within the United States some crop is pretty sure to be seriously damaged by the insects or fungous growth nearly every season.

An idea of what this annual battle means to the farmers can be faintly appreciated by examining some of the common insect pests that regularly appear in our gardens and fields. Spring has barely opened before the first foes appear. Usually in our Northern and Middle States the currant worms are the first formidable enemies to appear in numbers. These appear early in June and sometimes late in May. The saw-fly weeks before this has deposited its eggs on the gooseberry and currant bushes; and from these eggs emerge the deadly and destructive currant worms. Before the fruit has set they will completely defoliate the bushes, unless the farmer energetically sprays them with hellebore in kerosene emulsion—the best remedy so far devised.

An early, and two subsequent, sprayings of this emulsion must be made to save the currant and gooseberry bushes. While work is in progress on the currant bushes, the cherry and plum trees will be attacked by their most formidable foe—the plum curculio. The cherry trees do not suffer so severely from the curculio as the plum. All sorts of remedies have been tried and suggested for this tough little insect; but so far nothing has been found that will kill the curculio that will not also destroy the foliage of the trees.

A peculiar habit of the curculio has been discovered, however, which enables the farmer, with a little labor, to capture it. When a limb is jarred, the curculios roll up and drop to the ground, feigning death. If not disturbed in the grass, however, they very quickly recover their normal activity and return to their work. By spreading white sheets under the trees and by jarring the limbs with a long pole, the farmer can very easily collect a crop of the insects and burn them. To avoid doing injury to the trees, the poles are shod with a piece of rubber, which can strike against the limbs and not cut the bark.

The codling moth comes next upon the scene. The moth begins active operations on the apple trees before the blossoms have fallen, and it is at this season that the farmer must begin spraying for them. The curculio has not been disposed of by any means before the codling moth appears on the trees. The two must be fought at the same time. The apple trees must be sprayed with London purple just as soon as the petals begin to fall, and a second spraying should be administered in two weeks or less. As the codling moth may also appear on the pear trees, it is safer to spray with the same mixture.

The grapevines are subject to attacks from anthrax early in the season, and they must be swabbed with a solution of copperas, one pound to ten gallons of water. Later the Bordeaux mixture must be applied to prevent fungus spores from lodging on the vines. This is applied before the blossoms appear, and twice thereafter at intervals of ten to twelve days.

The apple and pear trees are liable to be attacked by anthrax or the scab, and the same celebrated mixture is used on them too. Where the scab appears on the bark in large blotches, the bark is scraped with a dull knife and washed with a kerosene emulsion and Bordeaux mixture.

The aphid and hop louse abound in great numbers on many trees and vines. They kill all the new growths of the cherry and plum trees, and later they swarm on the rose bushes. Their growth must be checked early in their career. This can be done generally by spraying them thoroughly with a strong kerosene emulsion.

Next come the potato beetles, and, if the potatoes have not been soaked in corrosive sublimate before planting, the scab will ruin the crop. Paris green is the celebrated remedy for the potato beetle. Fire rot appears on the blackberry and raspberry canes in June, and there is no remedy for this except to cut out the affected parts and stimulate the growth of the plants. The plum knot and peach yellows are the great summer foes that try the patience of farmers and baffle the ingenuity of scientists. The former is a fungous growth which appears early in June, but the spores of which are sown in September of the preceding year. The plum knot must be cut out with a knife in the spring and fall. In New York there is a law compelling all farmers to cut out the plum knot, under severe penalty. The knot must be burned immediately. When trees are covered with the knot, the best way is to cut them down and burn every part of them.

The peach yellows is also a fungous growth; and, like the plum knot, the most effective way is to cut it out and destroy it by fire. Liberal applications of the Bordeaux mixture sometimes prove a remedy for the yellows. The yellows cause enormous losses to the peach growers of the Delaware peninsula.

By the middle of summer insect foes are swarming all over the garden and on every plant. Plant lice or aphides attack all weak plants, and they multiply at the rate of five to twenty millions in a season from one progenitor. The red spiders appear in dry seasons, and the scale insects attack the bark and fruits of many trees. Scraping the trees and applying a wash of kerosene emulsion is the best remedy. The slugs of pear and apple trees must be treated to an application of hellebore. The rose bug and flea beetle must be attacked with the arsenites. The tomato rot seems to be invincible, and the squash bugs can only be destroyed by picking them off. The grub of the corn and cabbage fields is likewise a bad foe to deal with. The birds are its most formidable foes.

These are only some of the most common and formidable foes the farmers have to contend with in the summer season. Others appear at special times and in special localities. It would require a volume to write of all of them. The poisons used for remedies have been tried and recommended by the Agricultural Department, and every owner of a piece of garden land ought to be able to mix them at home.

The Bordeaux mixture is made of six pounds of copper sulphate, four pounds of lime, and twenty-five gallons of water. This is a strong solution, and a weaker one can be made by reducing the quantity of copper sulphate and lime.

A kerosene emulsion is made by mixing thoroughly one gallon of kerosene, one-half pound of good soap, and half a gallon of water.

London purple mixture is composed of one-eighth of a pound of London purple to twenty-five gallons of water. The same formula applies to Paris green mixtures.

A wash for scale insects is made of twenty pounds of resin, two and a half pounds of caustic soda to twenty-five gallons of water.

MANY spiders use their rope-making power in seizing their prey. They not only stab and poison their victim, but tie it, wing and leg, rapidly throwing over it coil after coil of sticky ligament, which soon not only render it helpless, but convert it into a mummy, thoroughly wrapped, and not only easy to carry, but put up for preservation, should the spider not desire an immediate meal.

Science Notes.

Prof. W. Crookes will be nominated as president of the British Association for the Bristol meeting of 1898.

The American X Ray Journal is published at St. Louis. The first number has just appeared. It is edited by D. Heber Roberts.

The Physikalisch-Technische Reichsanstalt is now using carborundum crystals to a great extent to replace diamonds in the production of finely divided scales, says the Electrician. Small flat hexagonal crystals are chosen of from half to one mm. side and mounted in a steel holder by means of a drop of shellac. The lines are said to be much more even than those produced by a diamond; they have been examined when magnified fifty times and found to be still sharply defined.

Mr. Clement E. Stretton, the general secretary of the National Railway Museum Association, speaking of his letter which was published in the SCIENTIFIC AMERICAN for May 29, says that the total number of English engines sent over was practically one hundred. He said that ninety-nine are certain, and probably one hundred and one is more correct. He is at present investigating the history of the two doubtful engines in order to settle the question in a satisfactory manner.

Efforts are being made throughout the State of New Hampshire to preserve Mount Washington from the lumber company which recently purchased it for \$100,000. The State makes no provision for the preservation of the forests, but the Appalachian Club at its next meeting will endeavor to induce the State to make a law which will cover the case. It is said that, if the lumber company is not restrained, the highest and best known peak in the East will be totally stripped of all verdure.

Two medical biographies of considerable importance have just appeared. The first is the "Life and Times of Thomas Wakley," by S. Squire Sprigge. Wakley is principally remembered as the founder of the London Lancet, but he was also celebrated as a politician in the best sense of the word, and his efforts in the cause of medical reform were eventually successful. The other work is "Vita Medica: Chapters of Medical Life and Work," by Sir Benjamin Ward Richardson, M.D., LL.D., F.R.S. In this volume, which was completed before his death, the author has given varied chapters on his memories of the last sixty years, with descriptions of some of the ideals he formed in the course of a long professional life. The book includes a considerable number of essays treating of personal observations and on subjects in the domains of science and philosophy.

It is bad enough when private individuals get in the hands of charlatans, but it is certainly difficult to think there exists not only private persons but public bodies who put more trust in the wild assertions of the charlatans than in the matured conclusions of science. The latest instance of gullibility, says Nature, comes from Bedfordshire, England. The local government board of a town wished to secure a water supply and they unanimously resolved to employ a water diviner. This gifted gentleman was employed, and the district counsel applied for a loan to carry out their plans, but fortunately the government auditor refused to audit the accounts. A boring of 700 feet had been made at this time and no water had been obtained. The auditor said it had been held that "the pretense of power, whether moral, physical, or supernatural, with intent to obtain money, was sufficient to constitute an offense within the meaning of the law," and he therefore thought that, as the diviner claimed to exercise some such power, his employment was clearly illegal, and the amount of his fee would be disallowed and the gentlemen who authorized the payment surcharged with it. The decision ought to materially reduce the number of believers in alleged divining rods, mineral rods, etc. This evil is as rife in our own country as in England.

Before deciding on the system of illumination to be adopted for a new girls' school in Vienna, the authorities invited firms experimentally to fit nine of the school-rooms with lamps, says the Trade Journals Review. This request was responded to, photometric measurements were made, the cost question entered into, and a well attended conversation held in the rooms. The Zeitschrift des Oesterr. Ingenieur und Architekten Vereins gives a plan of the rooms, with the positions, power, etc., of the lamps, and particulars respecting consumption of gas, or electricity, cost of maintenance and installation, etc. The diagrams and tables occupy one page of the journal. A great deal of information is offered in the most condensed state, but more explanatory notes would be desirable. The photometric tests were made after Weber and after Kauer. The committee have come to the conclusion that the lamps, incandescence, electric or gas lamps, should not be directly seen, but that diffused light should be applied, and that the lamps should be suspended 8½ feet above the desks, which in the rooms in question means about 3¼ feet below the ceiling. The installation of the electric lamps was considered cheaper than that of gas lamps, but the incandescence gas lamps would prove more economical to maintain.

SOME NOTABLE STEAM YACHTS.

We present two engravings of steam yachts which have recently been built in Scotland for American owners. We refer to the steam yacht "Andria," built by the Ailsa Shipbuilding Company, to the order of Mr. John E. Brooks, of New York, and the steam yacht "Mayflower," built by the Clydebank Engineering and Shipbuilding Company, Limited, at Clydebank, near Glasgow, to the order of Mr. Ogden Goelet. The photographs and the particulars of the yachts were furnished us by Mr. A. J. Sinclair, of Gourock, Scotland.

The "Mayflower" is the larger of the two boats. It is a steel twin screw yacht of 1,806 tons. It is the eighth largest yacht in the world and was built from the design of Mr. George L. Watson, of Glasgow.

The "Mayflower" is built on the spar deck principle,

the builders, consist of two sets of inverted triple expansion engines having eight cylinders, the diameters of which are 22½, 38 and 40 inches respectively, with a piston stroke of 27 inches. Steam is supplied by two double-ended return tubular boilers. The auxiliary engines on board are very numerous, including a refrigerating plant on the Kilbourn system. There is duplicate electric machinery, as well as a large battery of accumulators. Two powerful search lights are provided.

The "Mayflower" was launched at Clydebank, November 7, 1896. Her trial trips began on May 3, 1897, and on May 6 her official speed trial took place, the mean speed attained for several hours with continuous steaming being 16¾ knots per hour, equal to 19.288 statute miles per hour. The engines indicate 4250 horse power.

"Mayflower" built at Clydebank from Mr. Watson's design. It is exactly the same as the "Mayflower," and was launched on the 20th of February, 1897, when she was christened the "Nahma."

The "Andria," the other vessel which we illustrate, was made from the designs of Mr. G. L. Watson. She was constructed entirely of steel and has a clipper stem and square stern and is lightly rigged as a two-masted schooner, with two pole masts and bowsprit. The length on the load water line is 161 feet; the breadth is 23½ feet; the moulded depth of the hull is 13.7 feet; the tonnage is 433 tons according to Thames (yacht) measurement. The hull is divided into six watertight compartments by five bulkheads. She was launched on the 18th of February, 1897. She was towed to Glasgow to have her machinery and boilers

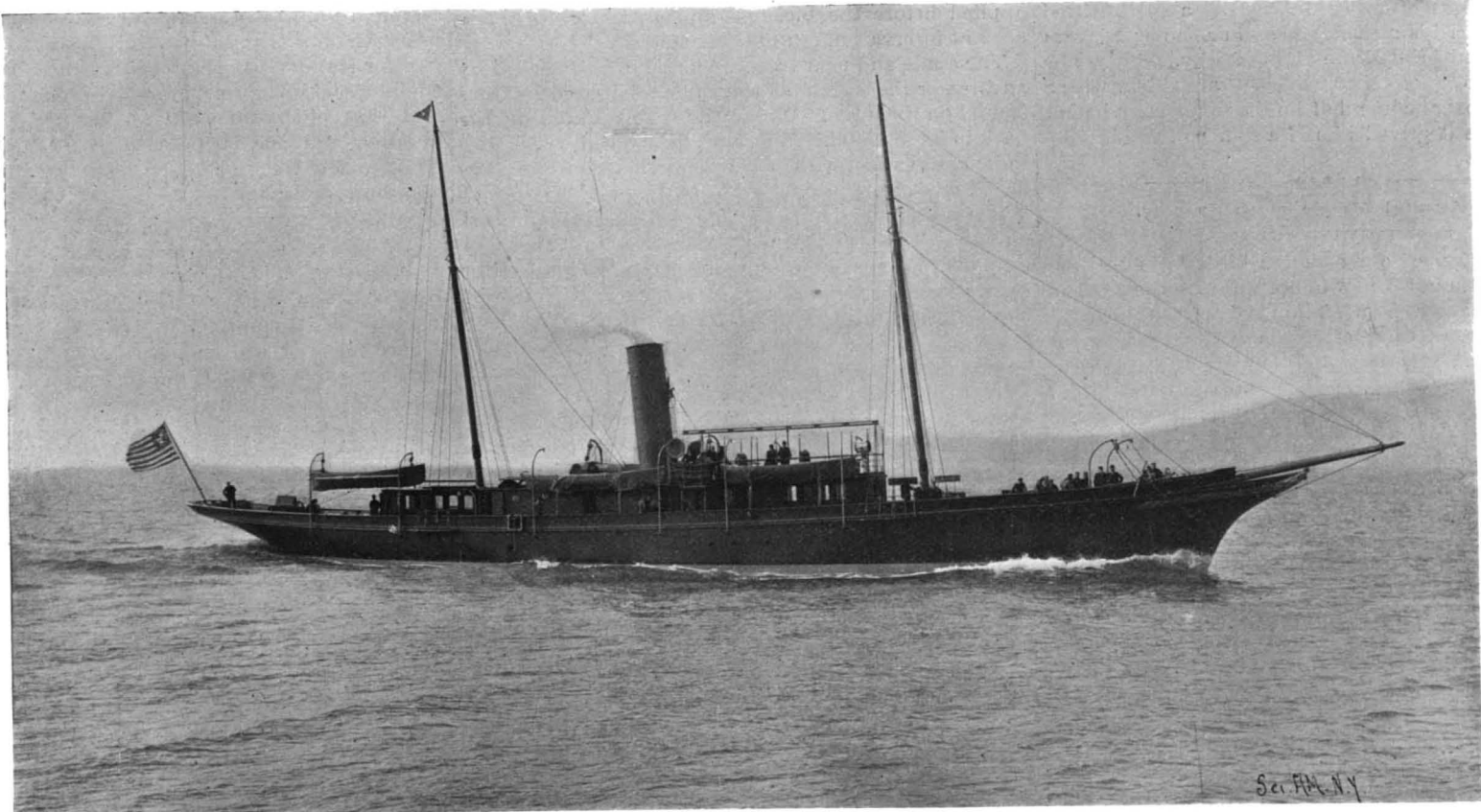

MR. J. E. BROOKS' ENGLISH BUILT STEAM YACHT "ANDRIA."

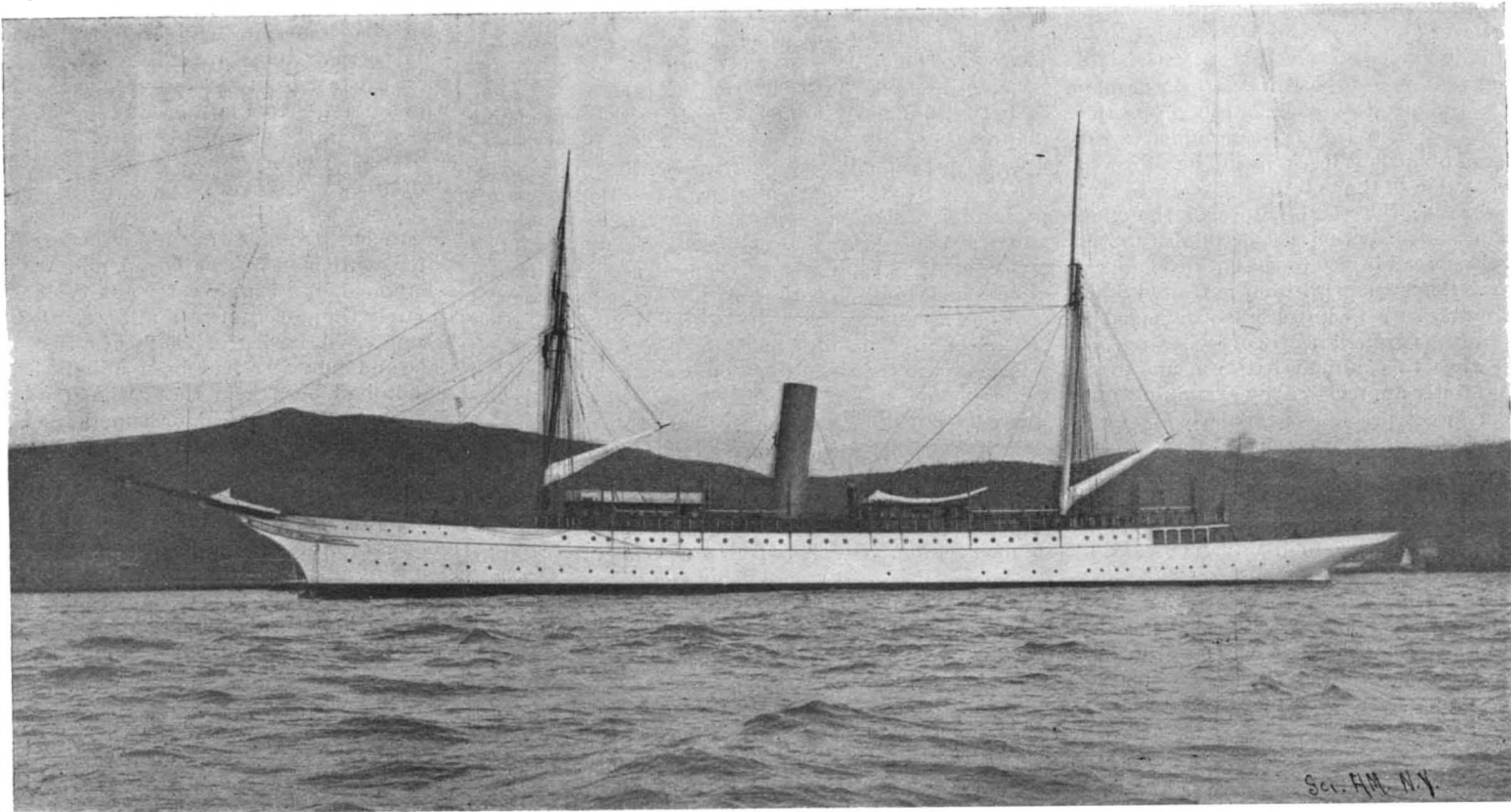

MR. GOELET'S NEW STEAM YACHT "MAYFLOWER."

with a well aft of the raised fore-castle head and forward of the foremast, while the promenade deck extends from the foremast to within a few feet of her stern. It is rigged as a schooner, having two masts with fitted topmasts. She has a standing bowsprit and running jibboom. Her dimensions are as follows: Length on load water line, 275 feet; between perpendiculars 288.8 feet; while the length from over the figurehead to the taffrail is 320 feet; the breadth is 36.7 feet; the depth of the hull is 17.7 feet. The net and gross tonnages are respectively 1008.89 tons and 1778.93 tons, with a tonnage of 1806 tons according to Thames yacht measurement, or 378 tons smaller than Mr. W. K. Vanderbilt's steam yacht "Valiant," which is the largest yacht in America.

The "Mayflower's" engines, which were supplied by

On June 5 she was towed to Gourock Bay, where she remained until the next day, when she left for Cowes. It was while she was in Gourock Bay that our correspondent had an opportunity of examining the beautiful vessel. Accommodations are provided for the crew and officers, who number ninety men all told. The space from the stem to the foremast is given up to them, but the rest of the vessel, fore and aft of the engines and boilers, is taken up by cabin space. The reason that the vessel was sent out in the unfinished state as regards some of the paneling and upholstery was that Mr. Goelet wished to have the "Mayflower" at the review at Spithead, where all the important yachts of Great Britain and many of those from abroad were in evidence at the Jubilee Naval Review.

Mr. Robert Goelet is having a sister vessel to the

put in place by Messrs. D. Rowan & Son, of Glasgow. On May 23 the yacht went on an official trial trip; a mean speed of 14.66 knots being obtained for a distance of 31.472 miles. The engines, which are of the triple expansion type, made 159 revolutions per minute with a pressure of 175 pounds of steam; they indicated 1,200 horse power. The diameters of the cylinders are 16, 26 and 41 inches; the stroke of the piston is 27 inches. Steam is supplied by a single ended multitubular boiler 14 feet in diameter and 10½ feet long. There are three corrugated furnaces. The vessel has bunker space for 70 tons of coal. In the engine room there are a number of auxiliary engines, including refrigerating, pumping, electric light engines, etc. The electric lighting plant supplies the 250 lights and a search light. The crew are berthed forward, aft of which are the

officers' quarters. The deck erections are of teak; the forward deck house, which will be used in warm climates as a dining room, is done up in mahogany. From here a staircase leads down to the dining saloon, which is an elaborate apartment, the sides of which are of ebony. Throughout the cabins there is a complete installation of electric bells and hot water heating arrangements. Forward of the saloon on the port side is Mrs. Brooks' room, which is finished in rosewood. Opposite Mrs. Brooks' room is the owner's room, adjoining which is a light bathroom and lavatory, the floor of which is mosaic. Aft of dining saloon, on the port side, is the pantry, with a lift to the galley, which is aft of the forward deck house. Near the pantry there is plenty of storage accommodation. Aft of the engine and boiler casing there is the after deck house, which will be used as the smoking room. It is a nice light compartment done up in rosewood. Going down the staircase from the smoking room we come to two handsomely got up staterooms on the port and starboard side. These are excellently furnished, the paneling being of sycamore wood. Aft of these rooms are a large stateroom and the ladies' cabin, both finished off in white enamel. The "Andria" carries quite a complement of boats on her davits, including a Dartmouth built ten and one-half knot steam launch.

The "Andria" was one of the yachts which took part in the Jubilee Naval Review at Spithead on June 24.

ROMAN BATHS.

In the earliest times we have records of people bathing in the rivers Nile and Ganges. From an early period the Jews bathed in running water, using both hot and cold baths and employing ointments. Baths

were also largely used among the Greeks, and they are credited with the invention of the hot air bath. The baths of the Greeks and probably of all the other European nations were on an insignificant scale as compared with those that eventually sprung up among the Romans.

The sturdy Romans of republican times used to throw themselves in the Tiber after exercising, but after ample supplies of water had been

accommodation of each public bath and 50 as that of the private baths, he estimates that over 62,800 people could have bathing accommodations at one time. In addition to this there was the Tiber and the streams in the Campagna.

Many of the baths were magnificent, the appointments being most luxurious. They were in a way gigantic clubs, stately and splendid pleasure houses, and from early in the morning, when they were opened, a constant stream of people passed in until they were closed at sunset. Though the baths were called "public," a small charge was made for admission. It was often only about one cent, but as cheap as this was, emperors used frequently to ingratiate themselves at times with the populace by making the baths gratuitous.

Visitors very often stayed an entire day in the beautiful buildings, enjoying the society of their friends. When the visitor entered the building, his outer wraps were given to a wardrobe keeper. He then met his friends and obtained the news of the day, after which he selected the variety of bath which he preferred, as warm, tepid, shower, cold or perspiration bath. After taking the bath he walked up and down the beautiful grounds, which were a feature of all the great baths. He then indulged in gymnastics or athletic sports to give him an appetite for the meal which followed. The dinner finished, the visitor could indulge in any of the many amusements which the enormous club house afforded, as concerts, literary entertainments, etc.,

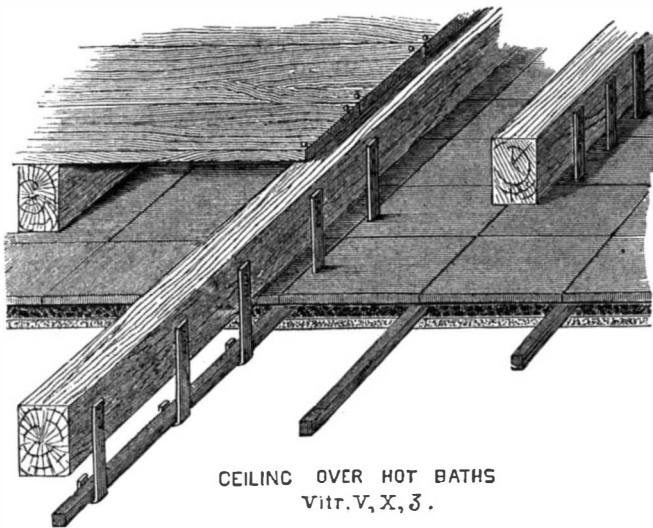

Fig. 1.—THE CONSTRUCTION OF A ROMAN BATH.

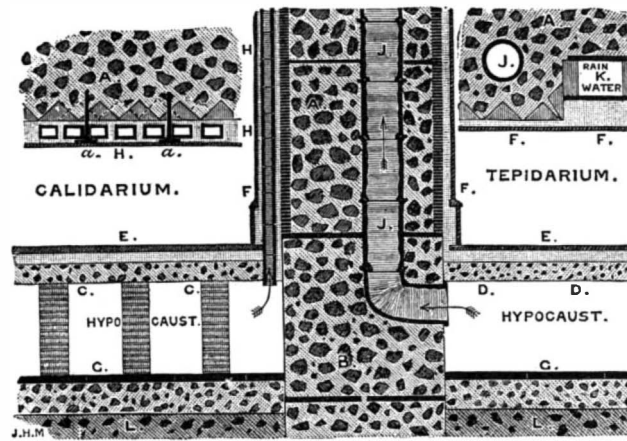

Fig. 2.—SECTION THROUGH THE FLOORS AND WALLS OF THE BATHS OF CARACALLA.

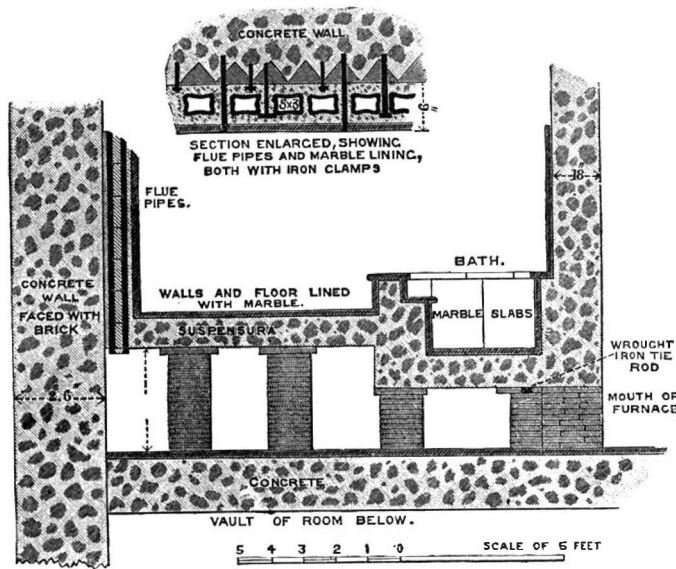

Fig. 3.—SECTION OF A PRIVATE BATHROOM IN THE ATRIUM VESTAE.



THE FRIGIDARIUM, OR SWIMMING BATH OF THE BATHS OF CARACALLA, ROME.

which were provided for those who wished to enjoy them. Sometimes a second bath was taken to prepare for the evening meal. It will readily be seen that as three or four thousand people visited the great baths every day, a very large number of servants and slaves were necessary to care for them.

The arrangements which were adopted to run the establishment are so interesting that we reproduce several engravings from the work of the late J. Henry Middleton, "The Remains of Ancient Rome." These illustrations show the methods of heating and fireproofing the baths. We also give an illustration of the present condition of the "frigidarium" or swimming bath of the Baths of Caracalla. The portion of the baths which we shall consider is entirely separate from the constructions which were devoted especially to the entertainment of the bathers. The chief rooms in the largest establishments appear to have been put to distinct uses, but in the smaller baths, one chamber was made to do duty for more than one purpose. The chief departments in the large baths were:

1. The *apodyterium* or *spoliatorium*, where the bathers undressed.

2. The *alipterium* or *unctuarium*, where the oils and ointments were kept (although the bathers often brought their own pomades), and where the "alipiae" anointed the bathers.

3. The *frigidarium*, or cool room (*cella frigida*), in which usually was the cold bath, the *piscina* or *baptisterium*.

4. The *tepidarium*, a room moderately heated, in which the bathers rested for a time, but which was not meant for bathing.

5. The *calidarium*, or heating room, over the *hypocaustum* or furnace; this in its commonest arrangement had at one end a warm bath, the *alveus* or *calida lavatio*; at the other end in a sort of alcove was:

6. The *sudatorium* or *laconicum*, which usually had a labrum or large vessel containing water, with which bathers sprinkled themselves to help in rubbing off the perspiration.

The rooms which were devoted to bathing proper were often of enormous size. The walls were usually constructed of brick or concrete and the roof was also of concrete. It was necessary to have the walls and ceilings fireproof, as a certain amount of wood was used in the construction.

We present an engraving giving a perspective sketch and section to illustrate the Vitruvian system for protecting the wooden ceiling joists over the hot rooms of the baths by an inner ceiling of tiles. The air space helped to keep the room at an even temperature. The whole under surface of the woodwork had a series of iron bars at intervals of two feet. These bars were supported by iron hooks nailed to the ceiling joists. Tiles two feet square were laid on the rows of iron bars, thus covering the whole area of the ceiling. The under side of the tiles was covered with a very hard cement called the "opus signinum." Entirely over this was laid an ornamental coating of fine whitestucco made of pounded white marble, the so-called "opus albarium." This was so constructed as to prevent the condensed steam from the hot baths striking through the plaster ceiling and the tiles, and causing the wooden joists to rot.

The floors of the baths were carried upon what are called crypto-porticoes, which allowed the servants to appear suddenly in all places, enabling them to attend to the requirements of the bathers without crossing the halls or interfering in any way with the noble Romans. The description by Vitruvius of the hypocausts or hollow floors used for heating the calidaria or hot rooms agrees closely with the existing ruins. We present an engraving, Fig. 2, from Prof. Middleton's work showing sections of the floors and walls of the baths of Caracalla, illustrating the different methods of heating. The *tepidarium* being heated by the hypocaust only, and the *calidarium* both by the hypocaust and the flue tiles up the walls. The following reference to the engraving shows the method of the construction in detail:

AA, concrete wall faced with brick; B, lower part of wall with no brick facing; CC, *suspensura* or upper floor of hypocaust supported by pillars; DD, another floor with support only at the edges; EE, marble flooring; FF, marble plinth and wall lining; GG, under-floor of hypocaust paved with large tiles; HH, horizontal and vertical sections of the flue tiles which line the walls of the *calidarium*; aa, iron holdfasts; JJ, socket jointed flue pipe of *tepidarium*; K, rectangular rain water pipe, used where there was a copious down-flow of water; LL, vaults of crypt, or basement, made of pumice stone concrete.

The lower floors were laid with 2 foot tiles over a bed of concrete; and on this all over the room rows of pillars were built to support the upper or hanging floor (*suspensura*). These pillars were 2 feet high and were constructed of tiles 8 inches square, set not in mortar but with clay in the joints. In the existing examples these clay joints have been baked into brick by the action of the fire which played among the short pillars all over the space below what is called the *suspensura* (C C). The example of the hypocaust on the left side of Fig. 2 agrees exactly with the description of

Vitruvius. Thaton the right is a later variety. It was from these hollow or hanging floors that Roman baths were sometimes called "*balnea pensilia*" or "*balnea pensiles*." In later times the architects became bolder in their use of cements and concrete, so that the tiled pillars were frequently omitted and the whole upper floor was supported only at the edges as if it were one immense slab of stone. The *suspensura* or floor was about 18 inches in thickness and was formed of four distinct layers. This main mass was of rough concrete, then came a layer of pounded brick and potsherds. Over this was laid a thin bed of hard white marble cement, and upon it was embedded the marble tesseræ or slabs, which formed the upper surface of the floor. The furnace was at one side or below the hypocausts, and the heated air or smoke from it, after circulating between the two floors, escaped up the flue which was formed in the thickness of the concrete walls. This flue was usually formed of a jointed pipe about 10 to 12 inches in diameter. The fluid concrete was poured around these flues. It is probable that the flues were continued above the roof, terminating in a chimney pot for the exit of the smoke, so that there was little risk of any rain water leaking in around the chimney pot.

Another method of heating is given by Prof. Middleton, and is shown at H H, Fig. 2. This was done by lining the hollow wall surface of the bath room with upright lines of flue pipes rectangular in section. These flues communicated at the bottom with the space under the *suspensura* and they were carried up to the top of the building, where the hot air and smoke escaped. Thus the whole wall surface, as well as the hollow floor, was strongly heated. It is believed that the exits of a large row of flue tiles were converged at one point before issuing to the roof.

The methods of heating which have been described were used not only under and around the hot air baths in the great "Thermae," but in the baths of private houses, as the "*atrium vestae*," or house of the vestal virgins.

Fig. 3 gives a section of the small bath room in the upper floor of the *atrium vestae*, showing methods of heating with the hypocaust furnace and the lining of the flue tiles up the walls. The hollow hypocaust passes under the floor of the room and also under the hot water bath, which is made of concrete faced with thin slabs of white marble. The mouth of the furnace is immediately under this bath, which is 6 feet long, 3¼ feet wide and 2 feet 4 inches deep. The pillars made of tiles, which support the *suspensura*, rest on the barrel vault of the room below. The space between the arches was filled in level with concrete and then paved with tiles, and upon these tiles the pillars rest. Three of the four walls of each of these rooms are covered with a hot air jacket in the form of a rectangular flue tile, which are bedded and covered with a thick mass of cement, against which the marble slabs rest, lining the whole surface of the walls.

This is shown in the horizontal section in Fig. 3. It also shows the nails which are driven into the joints of the brick work to form a "key" for the cement into which the flue tiles are bedded, also the T shaped clamps which are used at a few places to hold the flue tiles, and also the long iron or bronze clamps to hold the marble slabs. One end of these clamps is driven deep in the concrete wall, the other end is turned down in the upper edge of the marble slab. This interesting portion of the *atrium vestae* appears to date from the time of Severus, about 200 A. D., when important alterations and repairs were carried out. As the house decreases in importance, of course, the size of the bath rooms also decreases, but the general principle which governs the structure is the same, and therefore it affords an interesting study for the architect and archæologist. It is a curious fact that many of our modern systems of fireproofing structures depend largely upon the methods which the Roman architects used in constructing their baths.

The ruins of the Baths of Caracalla seem very confusing, but as soon as the orientation is understood, the plan of the enormous construction begins to unfold itself to the visitor, and he begins to understand how it was that the Romans were able to build masses of buildings easily and economically. When we consider the vaulting, which will probably always remain the crux of the architect who attempts to build in the Roman style, we must remember that it is not arched construction, but is monolithic. With his semiliquid cement the Roman architect was enabled to really cast his vaults. "Grandeur was the dominant trait of antique Rome," and even the coarse splendor of the empire could not efface the racial feeling for mass.

DR. KANDT, a German explorer, has started out to find the ultimate sources of the Nile. Having the promise of assistance from the Congo authorities when he reaches their territory, he has set out from German East Africa, intending to make his way to Urundu, Uhha, and Ruanda. There he will ascertain the size of Lake Akenjaru and measure the volume of water in the rivers Kagera, Ruvuru, Nyakirongo, and Akenjaru in the dry and wet seasons. He will trace that having the greatest volume to its source.

INTERESTING RECENT INVENTIONS.

We give herewith a group of recent inventions for which patents have been issued by the United States Patent Office within the last few weeks. They show the versatility of inventors, and seem to indicate that subjects for invention are not wanting. These examples are taken because of their novelty and originality.

ALMOND'S ROTARY ENGINE.—We have shown an improvement in that class of rotary engines in which tangential cylinders provided with outwardly movable pistons are contained within concentric casings. This invention has some features of interest which we do not remember to have seen in previous forms of rotary engines.

The housing, A, is stationary. The shaft, B, is arranged eccentrically in the housing and carries the head of the engine, consisting of four tangentially arranged cylinders, C, D, E, and F, provided with pistons, C², D², E², F². The outer end of each cylinder is open so as to allow the piston to protrude. The inner end of each cylinder has a port, j, for the admission and exhaust of steam. Steam is admitted by a pipe, G, to an inlet pipe, k, formed in the head, d, of the housing, and it is exhausted through the pipe, H, from an outlet port, l, which is also formed in the head, d. The inlet port, k, is of such length as to allow the cylinder, F, as soon as it moves from the position shown, to receive steam, which it continues to receive until it reaches the position of the cylinder, D. The outlet port, l, is of such size and length as to allow a cylinder to exhaust when it reaches a position a little in advance of the position of the cylinder, D, as here shown, and it continues to exhaust until it reaches the position occupied by the cylinder, F.

Each of the pistons carries on a tubular central stem a pivoted shoe, having a steam passage in its pivotal portion communicating with a steam space formed in the shoe, and between the shoe and the cylindrical wall of the housing, A. When steam is admitted to a cylinder, it passes through the tubular stem into the steam space in the shoe, forming a cushion which opposes the outward pressure of the piston, thus avoiding friction, the steam space in the shoe having approximately the same area as the piston itself.

Rotary motion in this engine is the resultant of the outward pressure of the pistons and their angular advance.

This interesting machine is the invention of Mr. Thomas R. Almond, of Dunwoodie Heights, New York.

TURNER'S FIELD MAGNET.—This improvement in field magnets of dynamo electric machines and electric motors was invented by Mr. Charles P. Turner, of this city.

The magnetic permeability of iron used in the field magnet cores of dynamos and motors is much affected by the presence in the iron of carbon, phosphorus and other impurities, which decrease the power of the field magnets for creating lines of force. Alloying iron with other metals also causes losses which are considerable.

This invention is designed to partly or wholly prevent these losses and thus increase the efficiency of the dynamo or motor. The invention is extremely simple. It consists in the combination with the polar extremities of the cast or wrought iron field magnet of a facing of pure iron on the surface adjacent to the armature. The pure iron is deposited electrolytically, and being homogeneous throughout, insures greater permeability than can be realized in the best forgings or castings.

LIVINGSTON'S SOUNDING BOARD.—The engraving only half conveys the idea of the important invention it is designed to illustrate. This is a new sounding board for pianos and other musical instruments, which is designed to give the instrument a greatly improved quality of tone in both the treble and bass, the resonant qualities of the sounding board being proportioned to the requirements by using soft grained wood in the board in the regions vibrated by the lower strings, and fine hard grained wood in the portions vibrated by the higher strings.

In the construction of this sounding board the inventor not only improves the quality of the board, but he is enabled to use short pieces of hard grained lumber which have heretofore been wasted.

The inventor, Mr. James C. Livingston, of Little Falls, N. Y., has succeeded in securing broad claims for his simple but important invention.

LOTHERINGTON'S SAIL ATTACHMENT FOR BICYCLES.—The illustration shows an attachment to bicycles, which will be appreciated by wheelmen, who, after having ridden against head winds, are able to set sail and go without exertion in the opposite direction.

The invention is a simple and compact attachment by means of which sails, carried by spring rollers, are spread and held in the position of use by gaffs hinged by a ball and socket joint to the upper end of the roller casings. The gaffs, when the sails are furled, lie over the sails in the casings or tubes, closing them. The rider may readily set the sails by pulling chains or cords attached to the gaffs.

The inventor of this device is Mr. Thomas Lotherington, of Ardmore, Indian Territory.

BERG'S FRED WATER REGULATOR.—This is a differential feed water regulator, used for regulating the

supply of feed water to a steam boiler or a battery of boilers, and is to be used in connection with boiler feeders of various kinds, and, when it is desirable, it is furnished with a high and low water alarm.

The shell or casing, A, is divided into four chambers; the main chamber, a, the interior chambers, a' and a², in the lower part of the casing, and a sediment chamber, a³. This chamber is connected by a pipe, a⁴, with the water space of the boiler. As the difference between high and low water in a boiler is comparatively

small, the motion of the water from a steam boiler to the bottom of the chamber, a³, and back into the boiler is slow and steady, so that the sediment contained in the feed water can be readily collected at the bottom of the chamber, a³. There is a screw plug in the bottom of the casing for removing the sediment.

The casing is provided with the usual accessories, such as a water gage, pressure gage, etc. On the exterior of the casing is formed a lip which is located on a level with the main water level of the steam boiler. A valve cylinder, B, is supported in the horizontal top and bot-

tom walls of the interior chamber. It has three groups of ports, the groups—upper groups—being arranged near the upper end of the valve cylinder, while the lower group is located in the chamber, a'. The valve cylinder, B, is provided with inwardly projecting annular ribs, to which is fitted a connecting tube, B', forming in the interior of the valve cylinder two spaces, a cylindrical space and an annular space. The middle and lower groups of the ports communicate with this annular space, while the upper groups of ports

the chamber formed in the inverted float, C, so that the air space therein is constantly supplied with air. The upper part of the casing, A, is connected with the steam room of the boiler by pipes, a⁵, a⁷. With the rise of the water in the steam boiler, the float valve is moved upwardly, so that the middle group of ports is gradually closed, and the pressure in the discharge pipe of the feed pump gradually increased and the motion of the feed pump retarded. The steam cylinder of the feed pump is provided with a pressure regulator

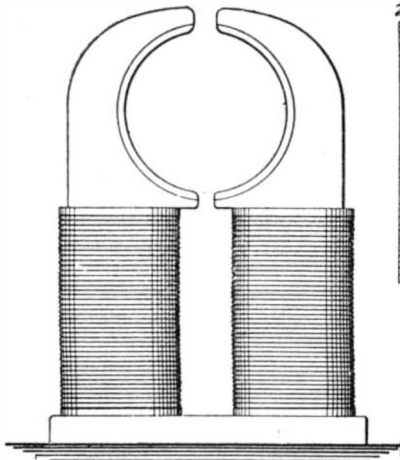

TURNER'S DYNAMO ELECTRIC MACHINE AND ELECTRIC MOTOR

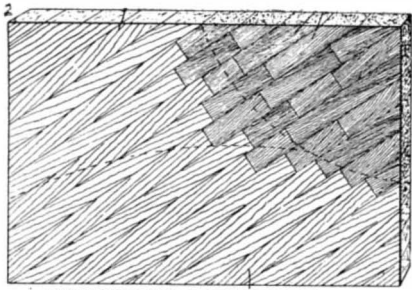

LIVINGSTON'S SOUNDING BOARD

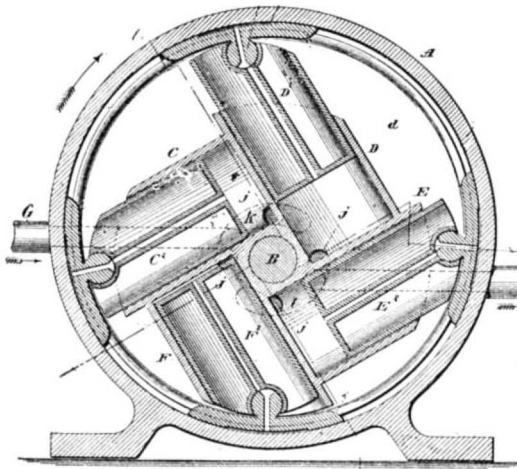

ALMOND'S ROTARY ENGINE

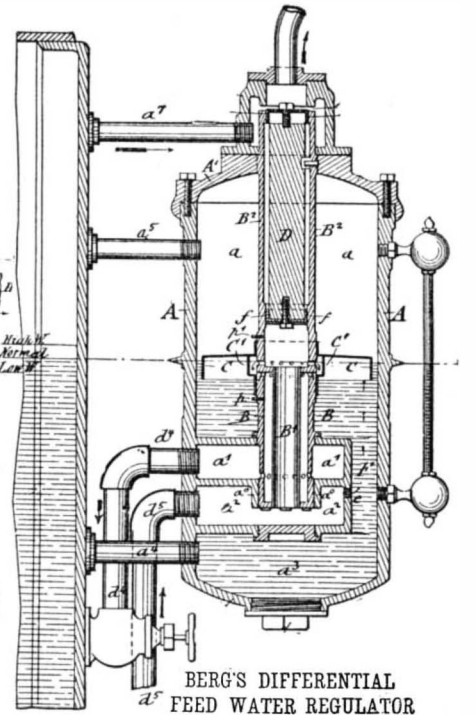

BERG'S DIFFERENTIAL FEED WATER REGULATOR



BROOKE'S CIGAR LIGHTER



LOTHERINGTON'S SAIL ATTACHMENT FOR BICYCLES

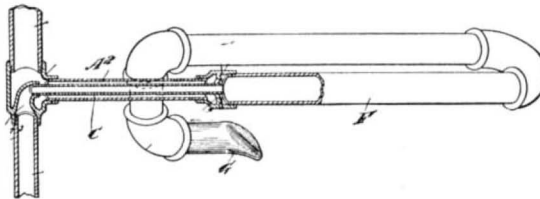

BARRETT'S HYDROCARBON BURNER

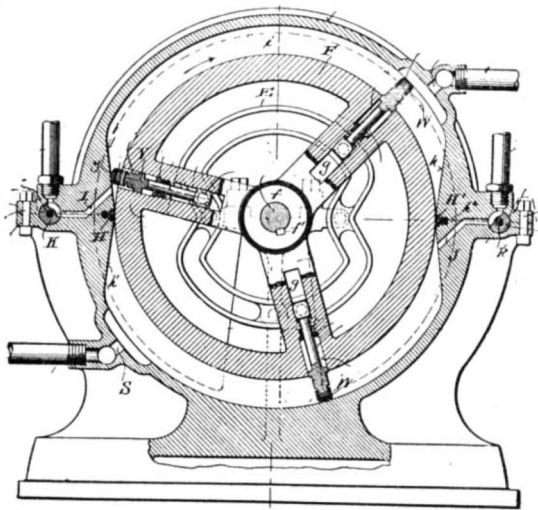

FLEISCHER'S ROTARY ENGINE

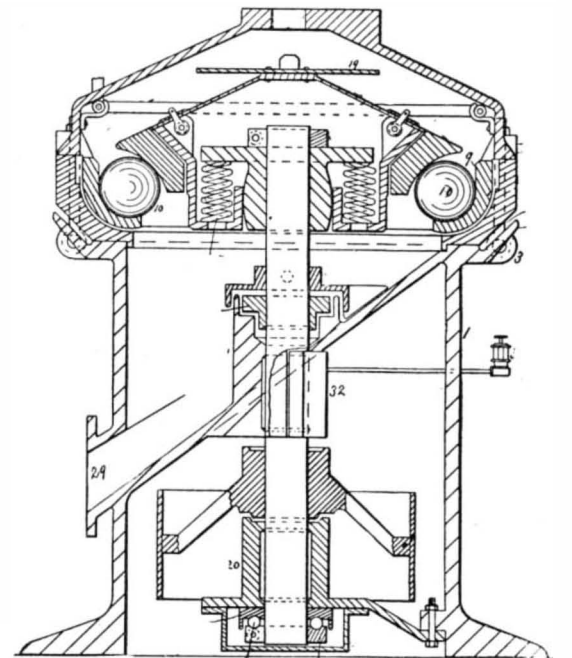

MORRIS'S BALL PULVERIZER

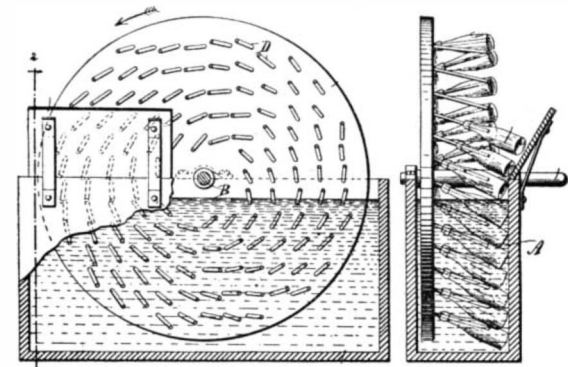

KERSTEN'S BOTTLE WASHER

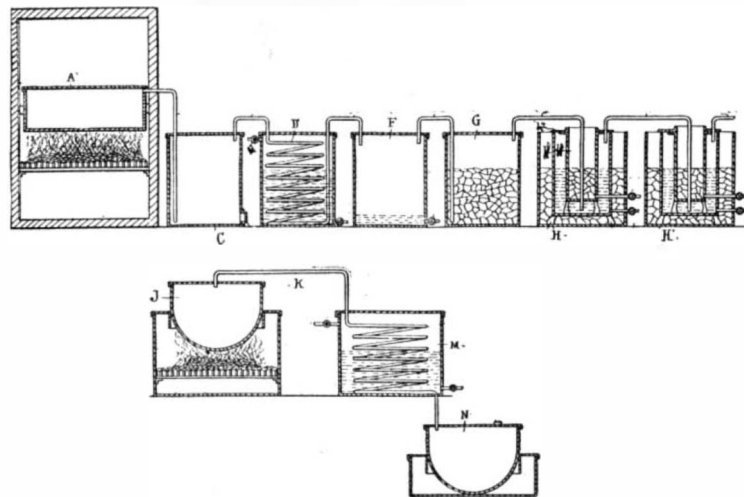

NAGEL'S PROCESS OF MAKING ARTIFICIAL CAMPHOR

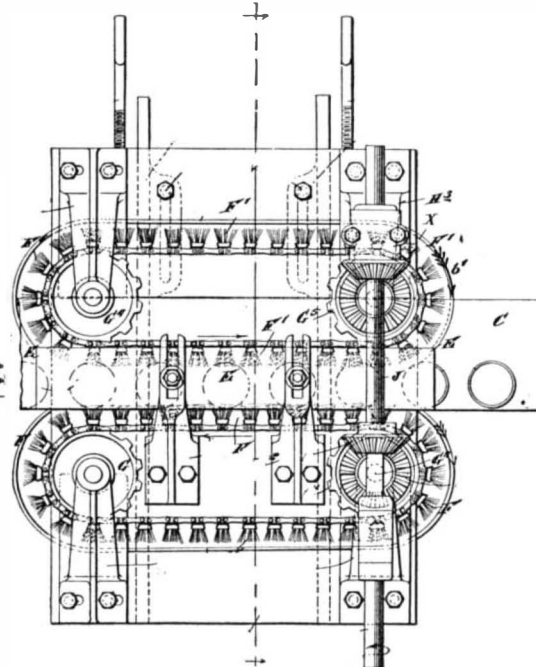

SEUFERT'S CAN WASHING MACHINE

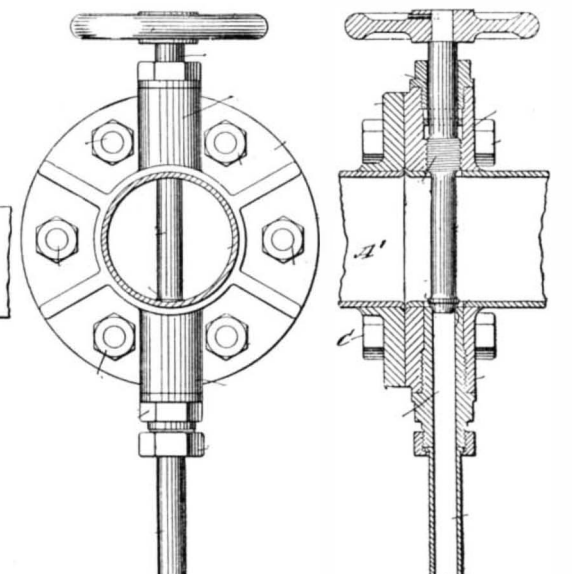

MARCHAUT & DORMOY'S VALVE

SOME RECENT AMERICAN PATENTS.

small, the motion of the water from a steam boiler to the bottom of the chamber, a³, and back into the boiler is slow and steady, so that the sediment contained in the feed water can be readily collected at the bottom of the chamber, a³. There is a screw plug in the bottom of the casing for removing the sediment.

The casing is provided with the usual accessories, such as a water gage, pressure gage, etc. On the exterior of the casing is formed a lip which is located on a level with the main water level of the steam boiler. A valve cylinder, B, is supported in the horizontal top and bot-

communicate with the interior space of the tube, B'. The intermediate group of ports is located in a groove or depression, which is larger than the ports. This group is opened or closed by the float valve, C.

The chamber, a', is connected by a pipe, d⁴, with the water space of the boiler, while the discharge pipe of the feed pump is connected with the bottom chamber, a², by a pipe, d⁵. In the chamber, a², is arranged a small perforated brass plug, e, which conducts to the main casing the air that is liberated by the heating of the feed water. The air rises and is collected in

which causes the opening or closing of the steam valve of the pump according as the pressure in the discharge pipe is increased or decreased.

When the pressure regulator is not used, the piston valve, D, is made to control the steam passing out of the pipe at the top and supplying the pump with steam.

When the water level in the steam boiler falls, the float valve is lowered by its own weight, and the middle group of ports is gradually opened, when the pressure in the discharge pipe of the feed pump is de-

creased, so that the motion of the pump is accelerated and the steam boiler is supplied with water according to the quantity of steam used.

The inventor of this feed water regulator is Rudolph Berg, of Pittsburg, Pa.

NAGEL'S PROCESS FOR THE MANUFACTURE OF CAMPHOR.—Early in the present century it was known that a product sometimes called "artificial camphor" could be produced in the laboratory, by passing hydrochloric acid through turpentine until the latter was saturated. The product, however, was not camphor, nor artificial camphor, but a hydrochlorinated terpene. It has lately been discovered that camphor can be made from hydrochlorinated terpene, and it is possible to produce camphor artificially on a commercial scale.

Oskar Nagel, of Vienna, Austria-Hungary, has invented a patented process in which hydrochlorinated terpene is converted into true camphor. In carrying out this invention, the inventor employs anhydrous hydrochloric acid and anhydrous turpentine; but a slight departure from the absolutely anhydrous state in either of the materials named does not cause a failure in the process. Hydrochloric acid gas is first produced and dried, and the turpentine, which may be any pure commercial article, is made by adding calcium chloride, which absorbs the water, and which is settled by filtration.

The anhydrous hydrochloric acid gas is passed through the turpentine until the saturation point is reached. During the passage of the gas through the turpentine both are cooled by a refrigerating agent, such as ice and salt. When the point of saturation is reached there is found in the vessel in which the operation has been carried on a crystalline substance and a heavy liquid. The latter is pumped off and filtered to obtain the crystals held in solution. These crystals with the crystalline precipitate are the hydrochlorinated terpene. These crystals are recrystallized with benzine or washed with alcohol; then the inventor mixes the same with lime, using about three parts by weight of crystals to one of lime; then distilling and producing camphene, and first a by-product, calcium chloride. The camphene is then treated with nitric acid under moderate heat, thus freeing the oxygen, which is taken up by the camphene, the product being camphor.

The apparatus by means of which the camphor is made is illustrated by the cut which shows the tank, A, in which is formed the hydrochloric acid gas, the heavy products being deposited in the tank, C. The gas then passes through the worm, D', which is cooled by water. It is then discharged into the closed tank, F. In this tank the moisture is condensed and separated from the gas and the dried gas passes off through the tank, G, containing calcium chloride. The gas is then passed into the tank, H, which is provided with an inner tank containing the turpentine. In this tank the combination of the hydrochloric acid gas with the turpentine is effected. The tank in which the combi-

nation is effected is kept at a low temperature by ice. The gas escaping from the turpentine in this tank is introduced in the same manner into the turpentine contained in the tank, H'. After the crystals are formed in the turpentine and precipitated, they are transferred to a vessel, J (shown in the lower figure), and the lime is added. The mixture is then distilled, the gas passing off through the pipe, K, to the worm in the vessel, M, where it is cooled.

The product at this stage of the process is camphene (C₁₀H₁₆). This camphene is then treated in the vessel, N, by adding thereto nitric acid. Other oxidizers may be employed in place of nitric acid. The result of this process is a body of crystals which may be compressed into a solid, and which is the same as the natural camphor found in commerce.

BROOKE'S CIGAR LIGHTER is designed to act as a shield for the end of a cigar while the match is introduced and the cigar is being lighted.

It consists of two similar halves stamped from sheet metal and fastened together with a rivet to form a chamber, into which the end of the cigar is inserted and which shields the flame of the match so as to prevent it from being extinguished.

This invention is due to Isaac Brooke, of Pottstown, Pa.

MORRIS' BALL PULVERIZER.—The machine shown in the engraving was invented by Mr. William L. Morris, of Cleveland, O., and is designed for pulverizing rock and ores carrying deposits of precious metals. In the upper part of the casing there is a circular channel or track, 9, in which are placed balls, 10, which are caused to roll around on the track by the carrier, mounted loosely on a vertical shaft so that it will not turn on the shaft, while it is capable of adapting itself to the work to be done.

The top of the carrier is provided with a disk, 19, on which the ore is delivered. When the shaft is revolved, the carrier, which rests upon the balls, causes the ball to travel around the ball track, and the material fed to the machine and thrown outwardly by centrifugal force is pulverized by the combined action of gravity and centrifugal force. The material pulverized drops into the chute, 29, and is delivered at the side of the machine. The spiral springs hold the driver down to its work.

FLEISCHER'S ROTARY ENGINE.—In this engine the piston consists of a cylindrical carrier, F, having three radial guides containing pistons, each having a rod extending inward and provided on the inner end with an arm carrying a roller which runs in the cam, E, and serves to keep the pistons in contact with the inner surface of the cylinder throughout the entire revolution of the engine, and to carry the pistons over the abutments which are on diametrically opposite sides of the cylinder. Steam is admitted through ports, I, J, and valves, K and K', in the abutments, and the exhaust passes out through ports, R, S. The pistons are packed and the abutments are provided with packing at H, H'. Steam can be cut off at any desired point

by means of the valves, K and K'. Mr. Richard J. Fleischer, of Milwaukee, Wisconsin, is the inventor of this engine.

BARRETT'S HYDROCARBON BURNER.—In this burner an oil feed pipe, C, is inclosed by the steam pipe, A², and a retort, F, extending outwardly, and is made in the form of a coil, upon the end of which is placed a burner, G, having a flaring mouth reaching under the retort, F. Steam issuing from the pipe, A², atomizes the hydrocarbon and passes it through the retort, the mixture being in condition to burn as it issues from the burner, G. The inventor of this burner is S. A. Barrett, of San Bernardino, Cal.

KERSTEN'S BOTTLE WASHER.—This machine consists of a disk carrying a number of pins projecting from the face thereof at an angle, the disks being mounted on a shaft and arranged to rotate in a tank filled with a cleansing solution. On the front of the tank at one side is arranged a guideboard which engages the butt ends of the bottles as they move downward into the liquid, and the tank is of such a width as to prevent the bottles from sliding off the pins during the time they are traveling through the liquid in the tank. As the bottles descend into the liquid they readily fill, and as they rise upon the opposite side they discharge the cleansing liquid back into the tank. The bottles are removed from the pins as soon as they emerge from the sterilizing liquid.

The engraving shows front and side views of this machine, which has been patented in the United States and several foreign countries by Emil Kersten, of Richmond, Va.

SEUFERT'S CAN WASHING MACHINE.—The rubber feed pipe, C, carries the filled cans forward under the cover, E, while the cans are acted upon by the brushes, F, F', mounted on endless chains and running in opposite directions. By means of this arrangement the cans are turned around several times in their passage through the machine. It is almost unnecessary to say that the cans and brushes are submerged in a cleansing liquid during the operation of washing. Guards are provided for preventing the water from splashing.

This invention was recently patented by F. A. Seufert, of The Dalles, Oregon.

MARCAUT & DORMOY'S VALVE.—The annexed engraving represents an improved valve designed for draining the water of condensation from a steam pipe,

On the end of the steam pipe is secured a thick flange, which receives bolts passing through the flange of the adjacent section. The bottom of the thick flange is formed of an enlargement into which is screwed an outlet or discharge pipe, having at its upper end a valve seat, and in the top of the same flange is a threaded opening above which is arranged a stuffing box. The valve is screwed into the opening, and the valve stem extends across the diameter of the pipe and holds the valve formed on the end thereof in contact with the valve seat. The valve stem is turned by the hand wheel when it is desired to open or close the valve. The inventors of this valve reside in Bordeaux, France.

RECENTLY PATENTED INVENTIONS.

Engineering.

CONDENSER.—Albert Hoberecht, Ensenada, Mexico. For locomotives and other engines, distilleries, and wherever it is necessary to condense steam or vapors, this inventor has devised a condenser with cold air tube extending centrally through its body and water intake within the flue, around which are cooling chambers having perforated portions, there being lateral air tubes and baffle plates. The condenser is designed to save the water now passing off in the exhaust and permit its use over and over again. The body of the condenser is divided into sections by the baffle plates, with an annular perforated air chamber in each section, the air chambers and baffle plates being preferably arranged in series.

SIGHT FEED LUBRICATOR.—Alexander A. De Witt, New York City. The reservoir forming a portion of this lubricator is connected at its lower end with the lower portion of the sight feed tube, there being a check valve between the feed tube and reservoir and opening toward the feed tube, and a plunger in the reservoir to regulate the height of the liquid in the feed tube. Any desired pressure may be applied upon the column of liquid in the reservoir, to make the feed of the reserve column in a measure automatic, and the liquid may be readily discharged whenever desired from both the reservoir and the sight tube.

Mechanical.

TOOL FOR STONE PLANERS.—Charles A. Thomson, Kearney, N. J. This is a tool for forming a corrugated or tooled surface at right angles to the travel of a planing machine, and is attachable to the ordinary tool head, to which the body of the device is bolted. Its lower portion has recesses to receive a cam-carrying shaft actuated by a flexible shaft connected with any convenient revolving shaft, and the body of the device has guides for the movement of a reciprocating plate to which is bolted the cutting tool, the plate having lugs embracing the cams, whereby the motion of the plate will be positive in both directions. The cutting tool may be of any width necessary to cover the surface of the stone operated upon, and the device may be attached to a tool head adapted to work on the side of the stone as well as on top.

Agricultural.

CORN HARVESTER.—James L. Hart, Grenola, Kansas. This is a machine which may be at-

tached to a lumber wagon or similar vehicle, when its cutting and directing apparatus will be fastened to the under side of the wagon bed in front of the hind wheels, and the dropping mechanism to the lower end of the wagon body. The machine automatically cuts the stalks, which are received on a dumping platform and delivered upon the ground when a sufficient quantity has been cut, the stalks being carried out of the path of the ground wheels. The machine may be accommodated to rows of different widths.

Miscellaneous.

HARDENING RAILS.—Harry C. Clement, New York City. To secure a more thorough and uniform hardening of rails this inventor provides a hardening tank having passage for the rail and a sprinkling device, a cooling tank having an entrance for the rail, which is received by carriages traveling on the tank transversely of the track of the hardening tank. Water is sprinkled against the head only of the heated rail, the rail being inverted so that as the water heated by contact falls away its place is supplied by fresh, cool water, and the hardened rail, while still inverted, having its head immersed in water.

HEATING AND VENTILATING APPARATUS.—William L. White, Princeton, Ind. According to this invention a jacket or casing surrounds a fire box or furnace proper, and is separated from it by a space for the air to be heated and passed into living rooms, the casing being made and supported independent of the fire box, and an outer casing surrounding the inner one, being attached to its cornice and supported at the base independently. The fire box and its casing may be used alone, the outer casing constituting an independent ventilating attachment which may be easily and quickly bolted in place or removed.

RADIATOR.—Augustus Eichhorn, Orange, N. J. To make an easily adjustable hot water radiator, for varying the degree of heat thrown off, this inventor employs a series of radiating loops communicating at each end, excepting one loop which has its lower end shut off from communication with the contiguous loops and its upper end in communication with them. This loop communicates at its lower end with a water feed pipe, and each end loop communicates with a return pipe, the latter pipes being valve-controlled and having air vents. The loops on each side of the feed may be thrown in and out of action by the opening or closing of the valves to the return pipes.

PERMUTATION PADLOCK.—Theodore R. Vincent, Salem, Oregon. This is a lock of simple and durable construction, which permits of many combinations, is inexpensive to manufacture, and is arranged to enable the owner to readily change the combinations to prevent unauthorized persons from tampering with the lock. The lock has a sleeve with longitudinal slot from which lead transverse recesses, tumblers turning on the sleeve having recesses registering with the slot, while a bolt engaging the sleeve has lugs engaging the slot. At the end of the shell is a graduation enabling the owner to bring the several tumblers into proper position for opening the lock.

SIPHON HEAD.—Emil Stahl, Hoboken, N. J. In heads to be attached to mineral water bottles or others where the waters are charged with gas, according to this invention, the head is so constructed that an excess of gas in the bottle, rendering it liable to explode, will cause the valve to open sufficiently to discharge the excess, thus rendering the bottle safe. The valve is spring-controlled and is located over and normally closes the outlet. It has a body portion sliding in the upper portion of the head, and is raised by a removable lever provided with a shoulder at the intersection of the head with the body, adapted to engage the valve body.

CABINET FOR BLANKS.—Abram M. Kinsel, George A. Hunter and Seth B. Nolley, Dallas, Texas. For use in hotels, post offices and other public places, this inventor has devised a cabinet for stationery, having a compartment with discharge opening at one end, a false bottom with spring beneath it, and a spring detainer having a pointed free end which presses upon the stationery, thus serving to prevent withdrawal of the sheet underlying the top one. The cabinet also has a similar envelope compartment, permitting the removal of envelopes singly as required.

STORM APRON CASE FOR VEHICLES.—William Fetzter, Sheldon, Iowa. This casing is preferably formed of carpet or similar material, its lower edge secured to a transverse strip upon the floor, which is adapted also to serve as a rest for the heel, while a suitable number of short straps secured to the front body of the vehicle are adapted to buckle with longer straps extending upward from the floor strip to hold the casing in place over the folded apron. The casing may serve as a boot rug when the apron is in service.

LAMP WICK RAISING OR LOWERING DEVICE.—William C. Quiggle, Pine Station, Pa. To enable a person to readily raise or lower a wick with either hand, from either side of a lamp, this inventor

provides a device of which the shaft or spindle extends on both sides of the lamp, there being at each end a head for turning the shaft, and each head having teeth, the teeth of the two heads standing in the same direction. As one places the fingers on the head, the direction of the teeth indicate the way in which the head should be turned to raise or lower the wick.

FIRE KINDLER.—Nicoll MacDonald, Mount Oliver, Pa. This is a kindler designed to produce a strong flame for about fifteen minutes, and then become a glowing mass for about fifteen minutes more, or until entirely consumed. It is made in the form of a hollow brick with detachable base section and transverse partitions, of pulped paper, sawdust and pulverized coal, and, after moulding and baking in an oven, it is saturated with a combustible compound, which preferably consists of a specified mixture of coal tar, crude petroleum and resin. A surface binding solution of flour, resin and water closes the pores and gives the article a glossy surface.

HAT HOLDER.—Julia Egan, Savannah, Ga. To securely hold a hat in a trunk or box, preventing the hat from being crushed or otherwise injured, this inventor provides a holder readily adjustable for hats of different sizes. It consists of a base adapted to be fastened by screws or otherwise to a tray or other fixed part, and on the base is a short post from which extend a series of arms each carrying a slidable spring clamp adapted to engage the hat brim and hold the hat in place. When the device is not in use, the arms may be removed from the post and folded to take up but little room.

ROCKER.—Joseph S. Byrnes, Brooklyn, N. Y. This is a device for use on chairs, bicycle saddles, etc., and consists of a base made in three sections and having a curved top, while a rail curved in an opposite direction to the top of the base is adapted to ride on it. On the under side of the central fixed section of the base is a lug to be screwed on the bicycle saddle post, and each of the two side sections is connected by a hinge to the central section. The rail, connected to the saddle, as it rocks forward on the top surface of the base, draws the rear section upward, swinging on its hinge, and when the rail rocks rearwardly the front section of the base swings upward, the rail being always permanently connected with the base, and the rail and seat readily following the movement of the rider's body.

MEAT HANGER.—Joseph Beaulieu, Hot Springs, Ark. A device especially adapted for

Advertisements.

ORDINARY RATES.

Inside Page, each insertion -- 75 cents a line
Back Page, each insertion ---- \$1.00 a line

For some classes of Advertisements, Special and Higher rates are required.
The above are charges per agate line--about eight words per line.

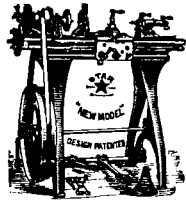

Star Foot power Screw... cutting Lathes Automatic Cross feed
9 and 11-inch Swing. New and Original Features

SCIENTIFIC AMERICAN SUPPLEMENT. Any desired back number of the SCIENTIFIC AMERICAN SUPPLEMENT can be had at this office for 10 cents.

POWER & FOOT LATHES. SHAPERS, PLANERS, DRILLS, MACHINE SHOP OUTFITS, TOOLS AND SUPPLIES. CATALOGUE FREE

SOMETHING NEW AND GOOD HALL BICYCLE STAND. For Cleaning, Adjusting or Exhibiting Bicycles

Price \$1.25. Send for circular. Liberal discount to dealers. Manufactured by WALWORTH MFG. CO.

STEAM STAMP MILL. A mill for crushing ores. Equal in efficiency to a five stamp battery, and at a fraction of the expense.

COBURN PATENT TRACK TROLLEY BARN and Fire Door Hangers. All Styles. Latest Improvements.

THE CHICAGO DRAINAGE CANAL. Description of a great engineering work undertaken to prevent the contamination of the city's water supply.

WORK SHOPS of Wood and Metal Workers, without steam power, equipped with BARNES' FOOT POWER MACHINERY

GREENERD ARBOR PRESS. Saves marring, upsetting or springing the arbors. Saves cleaning out the centers and taking off the dogs.

The Queen Acme No. 5 Microscope. NEW MODEL AS PER CUT. The Ideal Microscope for Amateur Research.

WIDE APART in their size, use, and cost are the numerous implements described and illustrated in the wonderful "BOOK OF TOOLS."

DEFIANCE MACHINE WORKS. BUILDERS OF HUB SPOKE, WHEEL BENDING, WAGON CARRIAGE AND HOOP MACHINERY.

PHYSICAL AND SCHOOL APPARATUS TOEPLER HOLTZ SELF CHARGING MACHINE
For School, College or X Ray work.

ROCK DRILLS AIR COMPRESSORS. SIMPLEST, MOST EFFICIENT AND DURABLE. RAND DRILL CO.

IMPROVED FILM JOINT CALIPERS. 12 sizes. 3 in., 4 in., to 24 in., \$3.00. Inside and outside. Joint has smooth and uniform friction.

OLDS Gas Engine. The Engine that has No Gears or Levers. Simplest Carburetor. Wonderful economy.

THE IMPROVED GAS ENGINE. Two cylinders in one casting. Occupies less space and weighs less for its power than any engine made.

DAYTON Combined Gas and Gasoline Engine. 2 to 50 H. P. Catalog free. Manufactured by Every Engine Guaranteed.

Pierce Gas or Gasoline Engine for any light work. Marine and Launch outfit complete.

STATIONARY ENGINES to 25 H. P. Send for catalog, stating size wanted. PIERCE ENGINE CO., 17 N. 17th Street, Racine, Wis.

THE EDISON PHONOGRAPHIC NEWS tells where and how you can procure cheaply A PHONOGRAPH OR A KINETOSCOPE

ALGO VAPOR LAUNCH. Motor controlled from bow. Valve movement, 12 to 1.6 to 80 ft. Launches. Twin Screws a specialty.

MONITOR AND MOGUL MARINE GAS ENGINES. LAUNCHES. NO INSPECTION, BOILER, FIRE, HEAT, SMOKE OR ODOR.

EDGE TOOLS. are often nearly ruined by using a grindstone not adapted to the work.

Table listing various mechanical parts and their prices, including locomotive boilers, engines, pumps, and tools.

STEAM ENGINEERING (Stationary, Locomotive, Marine); Mechanical Drawing; Architectural Drawing; Machine Design; Electricity; Architecture; Plumbing; Railroad, 31 COURSES & Bridge Engineering; Surveying and Mapping; Metal Pattern Cutting; Bookkeeping; Short-hand; English Branches; Mining; Metal Prospecting; All who GUARANTEED SUCCESS.

TELEPHONES for Long or Short Distance Use. Also Interior or Warehouse Telephones. Sent on trial to responsible parties.

Buy Telephones THAT ARE GOOD--NOT "CHEAP THINGS." The difference in cost is little. We guarantee our apparatus and guarantee our customers against loss by patent suits.

MAGNETO BELLS ALL KINDS OF TELEPHONES PARTS ELECTRICAL SUPPLIES

If you want the best Lathe and Drill WESTCOTT'S Strongest Grip, Great Capacity and Durability, Cheap and Accurate.

NOW IS THE TIME TO SUBSCRIBE FOR THE SCIENTIFIC AMERICAN

The most popular Scientific Paper in the World The SCIENTIFIC AMERICAN has been issued every week by the present publishers for a period of over fifty years.

The SCIENTIFIC AMERICAN should have a place in every dwelling, shop, office, school or library. Workmen, foremen, engineers, superintendents, directors, presidents, officials, merchants, farmers, teachers, lawyers, physicians, clergymen--people in every walk and profession in life, will derive satisfaction and benefit from a regular reading of the SCIENTIFIC AMERICAN.

As an instructor for the young it is of peculiar advantage. Try it.--Subscribe for yourself--it will bring you valuable ideas; subscribe for your sons--it will make them manly and self-reliant; subscribe for your workmen--it will please and assist their labor; subscribe for your friends--it will be likely to give them a practical lift in life.

A yearly subscription to the Scientific American is a most acceptable gift to a son or a friend.

NEW VOLUME COMMENCES JULY 1st. SUBSCRIPTION PRICE, \$3.00 a year, or \$1.50 for six months. Send your address for a free specimen copy. MUNN & CO., PUBLISHERS, 361 BROADWAY, NEW YORK.

HARRINGTON & KING PERFORATING
 WE CAN DELIVER RAPIDLY PERFORATED SHEET METALS
 OF EVERY DESCRIPTION
 NAME THICKNESS OF METAL, SIZE AND SHAPE OF HOLE
 225 NORTH UNION ST. CHICAGO, ILL. U.S.A.

BAND FASTENERS THE BEST
 A. P. DICKEY MFG. CO., RACINE, WIS.

FREEDOM FROM FIRE

No fear of being burnt out in residence, office, or factory as long as you use the
Stempel FIRE Extinguisher.
 Unequaled for simplicity, certainty, quickness and power in action. Adopted and indorsed by leading manufacturers. Best and most durable on the market. Illustrated catalogue free.
H. R. BENNETT,
 1215 Filbert Street, PHILADELPHIA, PA.

ELECTRIC STOVE.
 Enameled slate base. Hot in two minutes. Emergency cooking or heating—always ready. Price \$5.00.
 Complete, ready for use, with cord and plug. Give make of lamp socket and voltage.
AMERICAN ELECTRIC HEATING CORPORATION,
 BRANCH OFFICE: GENERAL OFFICE:
 Havemeyer Bldg., New York. Sears Building, Boston.
 Monadnock Bldg., Chicago.

DROP FORGINGS
WYMAN & GORDON
 WORCESTER, MASS.
 28 BRADLEY STREET.

AMERICAN PATENTS.—AN INTERESTING and valuable table showing the number of patents granted for the various subjects upon which petitions have been filed from the beginning down to December 31, 1896. Contained in **SCIENTIFIC AMERICAN SUPPLEMENT**, No. 1,002. Price 10 cents. To be had at this office and from all newdealers.

SO SIMPLE A CHILD CAN USE THEM
SUNART
 MAGAZINE CAMERA.
 Folding Cameras.
 All sizes, ranging in price from \$5 to \$100. Sunart Junior, 3/4 x 3/8 picture, \$5.
 Send 2 cent stamp for illustrated catalogue.
SUNART PHOTO CO.
 5 AQUEDUCT STREET, ROCHESTER, N. Y.

"It Tells About Cools"
 Every Mechanic, Metal Worker, or person interested in Machinery Supplies should have our new 1897 Tool Catalogue. It contains 710 pages, size 10 1/2 x 7 1/2, and is an exhaustive and instructive list of all tools that may be required. Handsomely bound in cloth, express paid on receipt of \$1. Money paid for book will be refunded with first order amounting to \$10 or over. Send stamps or money order.
MONTGOMERY & CO.
 MAKERS AND JOBBERS IN FINE TOOLS,
 105 FULTON STREET, NEW YORK CITY.

Scientific Books
 Our catalogue is sent free for the asking. It lists books pertaining to all the sciences. A copy should be had for ready reference by those desiring scientific, mining and technical books, which we sell to everybody at wholesale prices.
Montgomery Ward & Co., Chicago.

MEWER AUTOMATIC FEED DRILL
 An indispensable Labor Saver.
 Will feed, fine or coarse, at any angle, without loss of power. Warranted.
 For particulars, prices, etc.,
MEWER TOOL CO.,
 16 Elm St., Portland, Me., U. S. A.

PROPOSALS.
OFFICE LIGHTHOUSE ENGINEER, TOMPKINSVILLE, N. Y., June 26, 1897.—Sealed proposals for six fog-bell striking machines will be received here until noon, July 20, 1897, and then publicly opened. Information furnished on application. **D. P. HEAP, Lt.-Col. Engineers.**

THE OBER LATHE
 For Turning Axe, Adze, Pick, Sledge, Hatchet, Hammer, Auger, File, Knife and Chisel Handles, Whiffletrees, Yokes, Spokes, Porch Spindles, Stair Balusters, Table and Chair Legs and other irregular work.
 Patented. Send for Circular A.
The Ober Lathe Co., Chagrin Falls, O., U. S. A.

Drying Machines
 for Grain, Sand, Clays, Fertilizers, Phosphates, Green Coffee, Wet Feeds, Salt, Sugar, Chemicals, etc. 15 years in operation. Send for 6th illustrated catalogue.
S. E. WORRELL, Hannibal, Mo.

PERPETUAL DATER 25c.
 ALL your letters, bills and papers should be DATED! This Dater adjusts to ANY desired date INSTANTLY and will save you time, money and trouble. It is Rapid, Legible and costs practically nothing. To present you our catalogue of 500 specialties with a specimen **BARGAIN** we will send this dater post-paid for **ONLY 25c.** \$ for 60c. \$2.00 a dozen.
CONSECUTIVE NUMBER, numbers from 1 to 10,000, same price. **SEND FOR CATALOGUE.**
ROBT. N. INGERSOLL & BROTHER,
 Mail Order Bargain House,
 107 N. 2nd St., N. Y. City.

Tug fastener, hame, J. A. Condon.....	585,376
Tug shaft, J. C. Hackett.....	585,570
Turbine, gas, J. G. Sanderson.....	585,230
Typewriting machine, C. Sears.....	585,236
Typewriting machine feeding mechanism, C. Sears.....	585,235
Underflow testing apparatus, E. V. Hinkley.....	585,270
Universal joint, Atwater & Smith.....	585,549
Valve for steam car heating systems, train pipe, E. E. Gold.....	585,383
Valve reversing, J. Purves.....	585,522
Valves means for operating, W. Craig.....	585,377
Vanillin, obtaining, W. Majer.....	585,254
Vase and drag holder, combined, M. A. Snow.....	585,486
Vehicle brake, C. H. Inman.....	585,219
Vehicle draught attachment, J. N. Blakeslee.....	585,252
Vehicle, motor, H. R. Bird.....	585,251
Vehicle, motor, C. E. Woods.....	585,371
Vehicle, road, A. McNeill.....	585,386
Voting machine, F. H. Gilbert.....	585,326
Wall tie and anchor iron, G. W. Meserve.....	585,628
Warp threads, mechanism for handling, J. W. Foster.....	585,266
Washboard, M. S. Stock.....	585,183
Water heater, Turner & Mitchell.....	585,244
Water tube boiler, W. C. Stuckel.....	585,487
Water tube boiler, E. P. Watson.....	585,545
Water tube safety boiler and furnace for same, C. B. Humphrey.....	585,441
Watering device, stock, E. H. Tullis.....	585,414
Weather strip, S. E. Howard.....	585,520
Wedge shaving machine, automatic, G. L. Bigelow.....	585,375
Wheel, See Bicycle wheel. Car wheel. Fifth wheel. Wheel, Kydd & Mitchell.....	585,388
Wick adjuster and regulator, F. P. Glazier.....	585,436
Winding machine, cop, J. Zimmermann.....	585,247
Window, C. J. Clarke.....	585,510
Wire rolling machine, W. G. Allen.....	585,169
Wool cleaning machine, J. Brandy.....	585,617
Wrench, See Ratchet wrench.	585,617
Wrench, A. E. Jenks.....	585,443
Wrench, T. G. Thomas.....	585,412
Wrench, M. Wenger (reissue).....	11,614
Wrench attachment, E. C. Neal.....	585,329
Yoke lock, neck, G. A. Marquet.....	585,391
Zinc and copper from ores, obtaining metallic, Burghardt & Riggs.....	585,355

TRADE MARKS.

Antiseptic tablets, P. J. Pierce.....	30,295
Bacon, ham and shoulders, John Morrell & Company.....	30,303
Beer, malt tonic, ale and porter, Minneapolis Brewing Company.....	30,283
Boots, shoes, buttons, hats, collars, cuffs, dress facings and dress shields, Publishing, Advertising and Trading Syndicate.....	30,276
Bottle stoppers, Bernardin Bottle Cap Company.....	30,269
Canned fruits, vegetables, fish, oysters, lobsters, meats and poultry, Portland Packing Company.....	30,304
Cement, Portland, Atlas Cement Company.....	30,311
Coal of bituminous or semibituminous nature, Castner & Curran.....	30,313
Colognes and perfumes, W. M. Rivers.....	30,294
Diapers, Canfield Rubber Company.....	30,274
Duplicating devices, F. S. Webster Company.....	30,280
Flour, self-raising, Topeka Milling Company.....	30,306
Hair dye, W. H. Hambleton.....	30,294
Jewelry and cases and boxes containing same, certain, F. J. Goldsoll.....	30,263
Jewelry, fine gold, slipper, Howland Manufacturing Company.....	30,262
Knives and knife blades, C. D. Harrington.....	30,286
Lamps or lanterns, vehicle, E. M. Rosenbluth.....	30,267
Leather and textile fabrics, Publishing, Advertising and Trading Syndicate.....	30,278
Linen, silk, cotton, wool, and other fabrics, fabrics and articles, certain, Bruhl Brothers.....	30,275
Medicines, blood purifying, S. F. Giles.....	30,285
Metal polish, F. J. Amphlett & Company.....	30,307
Optical goods, including spectacles, eyeglasses, lenses, test cases and gages, American Optical Company.....	30,285
Packing, machinery, C. A. Daniel.....	30,280
Paper and paper articles, Publishing, Advertising and Trading Syndicate.....	30,259
Perfumes, Chapman & Rogers.....	30,288
Perfumes, antipyrctic and antineuralgic preparations, distillates, essences, and their derivatives, Basle Chemical Works Bindschedler.....	30,297
Pianos, mechanical or automatic, Aeolian Company.....	30,268
Polish wood, metal, leather, etc., material to, Rogers & Pratt.....	30,308
Remedies, certain named, Barbo & De Loenzi.....	30,286
Remedies, certain named, C. H. Roewekamp.....	30,287
Remedies for alcoholic diseases, tonic, R. A. Irving.....	30,293
Remedies for coughs, colds, catarrh and similar affections, Shilling Kennedy Company.....	30,290
Remedies for kidney diseases, T. J. Turner.....	30,282
Remedies for stomach diseases, rheumatism and female complaints, F. Bersuch.....	30,291
Remedy, cancer, D. Byer.....	30,288
Remedy, rheumatism, C. Muller.....	30,289
Selves, ointments and ointment, Karm.....	30,286
Ships' bottoms, compositions for, Holzappel's Compositions Company.....	30,310
Shirts and overalls, S. Liebovitz.....	30,272
Silver articles, either useful or ornamental, Watrous Manufacturing Company.....	30,304
Soap dissolved and used in convenient receptacles, Proctor & Gamble Company.....	30,300
Starch, laundry, R. I. Sherman.....	30,301
Starch polish, J. A. de Veer.....	30,302
Stove handles, J. E. Gattley.....	30,270
Stoves, fluid or oil, Novelty Manufacturing Company.....	30,271
Tobacco, leaf, F. Miranda & Company.....	30,282
Trousers, pants, overalls, shirts, jumpers, coats and vests, Evansville Woolen Mill Company.....	30,273
Watch movements, Hampden Watch Company.....	30,261
Whisky, H. Lightward, Jr.....	30,284
Woods, both in sawed and log forms, H. F. Purcell.....	30,312
Wool and wool fabrics, compounds for the treatment of, Merrimac Chemical Company.....	30,309
Woven textile fabrics for clothing, Hodges Fiber Carpet Company.....	30,279

DESIGNS.

Atomizer, S. E. Strong.....	27,257
Belt fastener, J. Hill.....	27,262
Bicycle stand, G. E. Stokes.....	27,273
Bottle, C. H. Beach.....	27,261
Bottle, S. J. Carr.....	27,260
Bottle, perfume, T. Brown.....	27,259
Buckle, A. A. Dawson.....	27,263
Button hook, J. A. Haskett.....	27,252
Card, sample, A. W. Clapp.....	27,281
Check, J. E. Farwell.....	27,251
Druggist's graduates, body for, C. E. Kemble.....	27,258
Fork fulcrum, H. W. Howard.....	27,275
Furniture support, F. W. Hill.....	27,272
Handle for pans or lids, W. E. Baxter.....	27,270
Harp sounding board, A. P. Roth.....	27,276
Hot air register, F. O. Farwell.....	27,269
Kitchen cabinet, A. E. Morton.....	27,254
Knife and cleaver, Beale & Carter.....	27,254
Lamp bulb, incandescent, J. T. Lister.....	27,267
Padlock case, E. T. Fraim.....	27,264
Puzzle board, F. W. Velsor.....	27,277
Ribbon, M. E. Wade.....	27,282
Silverware border, F. Cheron.....	27,255
Spoon or fork, G. W. Shieber.....	27,283
Stove base, H. R. Gummer.....	27,288
Target, W. R. Furness.....	27,280
Teapot or like article, A. F. Jackson.....	27,256
Thimble, E. Gerlach.....	27,250
Tire, bicycle, W. S. Gray.....	27,274
Toy, O. McDonald.....	27,279
Vitium crucifix, G. Styer.....	27,249
Whist tray, W. S. Coles.....	27,278

LABELS.
 "King of Cereals" (for cereals), Muscatine Oat Meal Company..... 6,549

PRINTS.
 "Bicycle Girl" (for cigars), American Lithographic Company..... 51
 "First rank" (for cigars), American Lithographic Company..... 52

A printed copy of the specification and drawing of any patent in the foregoing list, or any patent in print issued since 1863, will be furnished from this office for 10 cents. In ordering please state the name and number of the patent desired, and remit to Munn & Co., 361 Broadway, New York. Special rates will be given where a large number of copies are desired at one time.
 Canadian patents may now be obtained by the inventors for any of the inventions named in the foregoing list, provided they are simple, at a cost of \$40 each. If complicated the cost will be a little more. For full instructions address Munn & Co., 361 Broadway, New York. Other foreign patents may also be obtained.

THE ANDERSON TYPEWRITER BEATS SHORTHAND! One Stroke Prints a Word. 97 Nassau Street, New York.

NICKEL AND Electro-Plating Apparatus and Material.
THE T. H. LANSON & VAN WINKLE CO.,
 Newark, N. J.
 136 Liberty St., N. Y.
 35 & 37 S. Canal St., Chicago.

THE APOLLO COMPANY
 never turned out a false-gauge sheet of galvanized iron.
 Apollo Iron and Steel Company,
 Pittsburgh, Pa.

STORAGE BATTERIES
 THE WILLARD BATTERY CO., CLEVELAND, O.

ROSE POLYTECHNIC INSTITUTE
 A College of Engineering. Mechanical, Electrical, Civil Engineering, Chemical courses. Well endowed. Extensive shops. Modernly equipped Laboratories in all Departments. Expenses low. 15th year. For catalogue address C. L. MEES, President, Terre Haute, Ind.

THE NEW BRISTOL COUNTER

THE NEW BRISTOL COUNTER
 Registers an accurate account of work done on printing presses, grain mills, weighing, measuring and other automatic machines. Counts up to 1,000,000 and repeats automatically. Simple, accurate, durable. Special counters to order. Send for circular.
C. J. ROOT, Bristol, Conn., U. S. A.

WE UNDERSSELL ALL!
 Bicycle Electric Lights, \$4.00
 Necktie Electric Lights, 1.50
 Edison Electric Motors, 1.00
 Medical Batteries, 3.95
 \$100 Bicycles, best made, 39.00
 Electric Bells, finest, .30
 Dry Batteries, best, .25
 Agents Wanted.
 Our Bicycle Electric Light is the best thing that ever happened.
 Catalogue 2 cts.
OHIO ELECTRIC WORKS, Cleveland, Ohio.

COPY LETTERS
 fifteen a minute, all legible, use my improved automatic copying machine.
 Send for illustrated circular.
JOHN H. ANDERSON,
 910 Monadnock, CHICAGO.

WE MAKE HIGH GRADE STEREOPTICONS, MAGIC LANTERNS
 and accessories which will assist the physician to demonstrate microscopic lantern slides of the human blood, either normal or diseased.
 Call or write to
PETERS, MANTZ & CO.,
 Manufacturers and patentees,
 125 and 127 Worth St., New York

The Berkefeld House Filter.
 The only Filter Removing Typhoid and Cholera Bacilli. Tested and indorsed by many leading authorities in Europe and America. It gives a continuous flow of filtered water, absolutely free from germs. It is easily cleaned, as all impurities remain on the surface of the filtering cylinder. Cylinders can be sterilized by boiling in water for one hour. Send for circulars and prices to the Berkefeld Filter Co., 4 Cedar St., New York
 See Illus. Article in Scientific American, June 23, 1894.

DO YOU USE GRINDSTONES?
 If so, we can supply you. All sizes mounted and unmounted, always kept in stock. Remember, we make a specialty of selecting stones for all special purposes. Ask for catalogue.
THE CLEVELAND STONE CO.
 2d Floor, Wilshire, Cleveland, O.

STEEL STAMPS FOR MARKING TOOLS & C NAME STAMPS 10¢ PER LETTER. FIGURE & ALPHABET SETS AT LOWEST PRICES. ALL WARRANTED. SEND FOR CIRCULAR.
SCHWAAB STAMP & SEAL CO.
 MILWAUKEE, WIS.

AGENTS' OUTFIT FREE. No Capital Needed.
 Weekly sales pay big money.
 We make a high grade BICYCLE as low as \$24.00. Fully guaranteed. Shipped anywhere on approval, direct from our factory.
ALPINE CYCLE CO., Dept. 92, Cincinnati, O.

50 YEARS' EXPERIENCE.
PATENTS
 TRADE MARKS, DESIGNS, COPYRIGHTS &c.
 Anyone sending a sketch and description may quickly ascertain, free, whether an invention is probably patentable. Communications strictly confidential. Oldest agency for securing patents in America. We have a Washington office. Patents taken through Munn & Co receive special notice in the
SCIENTIFIC AMERICAN,
 beautifully illustrated, largest circulation of any scientific journal, weekly, terms \$3.00 a year; \$1.50 six months. Specimen copies and HAND BOOK ON PATENTS sent free. Address
MUNN & CO.,
 361 Broadway, New York.

Family Ice Machine Ice, etc., in a few minutes, \$10 and up. Filters, \$1.25 and up. Cookers, \$1. Seltzateurs to prepare one's self soda water, \$4.50 and up. L. DERMIGNY, 126 W. 25th St., N. Y.

AMPLIPHONE
 Speaking Trumpet
 For country, shore, and mountains. By its use ordinary speech can be distinctly heard for long distances.
 Send for Circular.
HAWTHORNE & SHEBLE,
 604-606 Chestnut Street, Philadelphia, Pa.

NICKLE PLATING WANTED.
 ORDERS EXECUTED IN ANY QUALITY OR QUANTITY.
BETTS & MABBETT CO., ROCHESTER, N.Y.
 29 NORTH WASHINGTON ST.

WE BUY PATENTS. small novelties. Columbian Novelty Company, 766 Broad Street, Newark, N. J.

FOR SALE.—Design patent No. 27,020 on Kitchen Cabinet. Addr. for terms: J. A. Overall, De Larrus, Mo.

MONEY ADVANCED to secure U. S. Patents. Address: Fritz Andrae, 256 West 21st St., New York

MODELS done on short notice. Catalogue free.
J. C. SEYI,
 181 Madison St., Chicago.

ICE MACHINES, Corliss Engines, Brewers, and Bottlers' Machinery. THE VILTER MFG. CO., 899 Clinton Street, Milwaukee, Wis.

A RARE OFFER.—For Sale: Exclusive right to Rogers spring rubber trunk protectors. Patent applied for. Has several advantages. For circulars & particulars address: Y. W. Rogers, General Delivery, St. Louis, Mo.

TYPE WHEELS, MODELS & EXPERIMENTAL WORK, SMALL MACHINERY NOVELTIES & ETC. NEW YORK STENCIL WORKS 100 NASSAU ST. N.Y.

Experimental & Model Work
 Ctrs. and advice free. Gardam & Son, 45-51 Rose St., N. Y.

STRONG CASTINGS. QUICK DELIVERY.
 PATTERN WORK TO ORDER.
ACME MALLEABLE IRON WORKS, BUFFALO, N.Y.

VOLNEY W. MASON & CO.,
 Friction Pulleys, Glutches & Elevators
 PROVIDENCE R. I.

500 Celebrated "Syracuse" Bicycles. New in original crates. Surplus stock must be sold at once, \$10 to \$50 large stock well-known makes. Shipped on approval. Send for Lists.
I. C. Brown-Lewis Cycle Co., Chicago.

WOODEN TANKS.
 For Railroads, Mills and Manufactories. Builders of Steel Towers and Tanks. La. Red Cypress Wood Tanks a specialty.
W. E. CALDWELL CO.,
 217 E. Main Street, Louisville, Ky.

LEHIGH PREPARATORY SCHOOL
 Best recommendations. Young men are prepared for Lehigh University, Yale, Harvard, Cornell, Princeton, etc. Over seven hundred pupils of this school have been admitted to Universities during the past eighteen years. For particulars apply to
W. ULRICH, Ph.D., Bethlehem, Pa.

CARBORUNDUM
 HARDEST ABRASIVE KNOWN. EMERY AND DIAMOND POWDER SUBSTITUTE. IN FLOUR, POWDER, CRYSTAL, WHEEL, SLAB & HOME FORM.
CARBORUNDUM CO., NIAGARA FALLS, N.Y., U.S.A.

BRASS BAND
 Instruments, Drums, Uniforms, Equipments for Bands and Drum Corps. Lowest prices ever quoted. Fine Catalog, 400 Illustrations, mailed free; it gives Band Music & Instructions for Amateur Bands.
LYON & BEALY, 33-35 Adams St., Chicago.

MANUFACTURE OF STARCH FROM Maize.—By J. Krieger. Full details of the process. With one illustration. Contained in **SCIENTIFIC AMERICAN SUPPLEMENT**, No. 1,012. Price 10 cents. To be had at this office and from all newdealers.

B & O
Solid Trains
 TO
all Points
WEST

Advertisements.

ORDINARY RATES.

Inside Page, each insertion - - 75 cents a line
Back Page, each insertion - - - \$1.00 a line
For some classes of Advertisements, Special and
Higher rates are required.

The above are charges per agate line—about eight
words per line. This notice shows the width of the line,
and is set in agate type. Engravings may head adver-
tisements at the same rate per agate line, by measure-
ment, as the letter press. Advertisements must be
received at Publication Office as early as Thursday
morning to appear in the following week's issue.

"Magnolia"
BEST ANTI-FRICTION METAL
MACNOLIA METAL CO.
266 & 267 WEST STREET; NEW YORK CITY.
For one 3-cent stamp we will send any Engineer, men-
tioning this paper, a 15-inch Brass Edged Ruler.

"Search=Light"
Always Bright.



SEARCH LIGHT

The Leader!

A lantern that does not jar or blow out.
Reflecting surfaces are always bright.
All riders say it is—THE BEST.

FOR SALE EVERYWHERE.
Bridgeport Brass Co.
Send for Catalog No. 196. BRIDGEPORT, CONN.

GARDNER GRINDER FOR FLAT SURFACES
FOR UP TO 15 INCHES
ACCURATE & RAPID
CHESLEY & CO. CHICAGO, ILL. U.S.A.

NEW PRICES
ON
Columbia Bicycles
The Standard of the World.

1897 COLUMBIAS	REDUCED TO	\$75
The best bicycles made,		
1896 COLUMBIAS	REDUCED TO	60
Second only to 1897 Models		
1897 HARTFORDS	REDUCED TO	50
Equal to most bicycles,		
HARTFORDS	REDUCED TO	45
PATTERN 2,		
HARTFORDS	REDUCED TO	40
PATTERN 1,		
HARTFORDS	REDUCED TO	30
PATTERNS 5 AND 6,		

Nothing in the market approached the
value of these bicycles at the former
prices; what are they now?

POPE MFG. CO., Hartford, Conn.
Catalogue free from any Columbia dealer;
by mail from us for one 2-cent stamp.

EXPERIENCE!



Pay \$ (X) you have a "Char-
ter"—the result of the Longest
Experience in building Gas-
oline Engines in the U. S.
Pay less than (X) you have
experiment at your expense—
inferiority—for We have the
Foundation Gasoline Engi-
ne Patents.
Catalogue, Testimonials
and a Letter by addressing
CHARTER GAS ENGINE CO., Box 148, Sterling, Ill.

MANUFACTURE OF BICYCLES.—A
very comprehensive article giving the details of con-
struction of every part of these vehicles. With 15 en-
gravings. Contained in SCIENTIFIC AMERICAN SUP-
PLEMENT, No. 908. Price 10 cents. To be had at this
office and from all newsdealers.

GUNDLACH OPTICAL CO.
761-765 S. CLINTON ST.
ROCHESTER, N. Y.

SEND FOR LIST OF MANUFACTURERS
OF PHOTOGRAPHIC APPARATUS.
OUR NEW CYCLE OUTFIT CAN'T BE
BEATEN FOR QUALITY OR PRICE.

Has Won Its Position
Purely On Its Merit.

Adopted and used by the United States Army.
We are prepared to offer direct to the rider
special price where we are not represented.
Write us for particulars.

THE MARTIN & GIBSON MFG. CO.,
BUFFALO, N. Y. (Drawer C.)

**BALL BEARING AXLES AND RUB-
BER TIRES.**—A paper read before the Carriage Builders'
National Convention, Philadelphia, October, 1894, show-
ing the advantage to be derived from the use of ball
bearings and pneumatic tires in road vehicles. Con-
tained in SCIENTIFIC AMERICAN SUPPLEMENT, No.
942. Price 10 cents. To be had at this office and from
all newsdealers.

Ride The "Olive"

EVER READY AND RELIABLE



Strictly high grade. Features—attractive, prac-
tical and substantial. Special price to riders
direct in unoccupied territory.

Strictly high grade. Features—attractive, prac-
tical and substantial. Special price to riders
direct in unoccupied territory.

The \$5.00
Falcon Camera
FOR 3 1/4 x 3 1/4 PICTURES.



Uses our
Light-Proof
Film Cartridges
For 12
Exposures and
LOADS IN
DAYLIGHT.

Improved safety shutter, set of three stops, fine
achromatic lens, view finder and socket for tripod
screw. Booklet Free.

\$2,853.00 in Prizes For Kodak Pictures.
\$1,475.00 in Gold.

EASTMAN KODAK CO.
ROCHESTER, N. Y.

A WONDERFUL LAMP.
A priceless boon to cyclists and
one that all wheelmen will appre-
ciate, is the
BELL ELECTRIC LAMP.
No wires to connect, no match
needed, no smoke nor smell, no
plates to recharge, no cost when
not burning—very little when it
is, no extra liquid to carry, no re-
charging every time used, no walk-
ing home when lamp is out.
W. POLLACK, Gen. Agent,
565 Boulevard, NEW YORK CITY.

PRIESTMAN SAFETY OIL ENGINE
"A thoroughly successful commercial En-
gine using a Safe Oil."—Franklin Institute
No Extra Insurance, No
Steam, No Gas, No Gasoline.
Reliable, Safe, Economical,
and Convenient. Chosen by
Nine Governments. Used for
nearly every purpose.
PRIESTMAN & CO., Incorp'd,
530 Bourse Building, Philadelphia, Pa.



HANDY WHEN IN A HURRY
A new article which no machine
shop should be without. Keeps
all drills compact, with their
gauges adjoining. Can lay your
finger in a second on the exact
drill you want.
THE WEISS DRILL CASE
is of cast iron with spring hinge
bar that raises at touch of the fin-
ger. Contains 30 round bottomed
receptacles, holding as many sizes
of drills, with drill-gauge oppo-
site. **Louis T. Weiss,** 291-293
Graham St., Brooklyn, N. Y.



**THE BICYCLE: ITS INFLUENCE IN
Health and Disease.**—By G. M. Hammond, M.D. A val-
uable and interesting paper in which the subject is ex-
haustively treated from the following standpoints: 1.
The use of the cycle by persons in health. 2. The use of
the cycle by persons diseased. Contained in SCIENTIFIC
AMERICAN SUPPLEMENT, No. 1002. Price 10 cents.
To be had at this office and from all newsdealers.

SMITH & WESSON Penetration Accuracy



send for Catalogue
REVOLVERS
14 STOCKBRIDGE STREET,
SPRINGFIELD, MASS.

Tribune Bicycle
Tested and True.



The Easiest Running Wheel in the World.
Send for Catalogue.

HALF A CENTURY OF CYCLES.—AN
interesting history of the cycle from its origin up to the
present time. The first crank-driven bicycle. The
"bone-shaker" and its successors. The tricycle. The
modern wheel. Cycle building a science. Points of im-
provement. The pneumatic tire. A hand and foot
cycle. With 9 illustrations. Contained in SCIENTIFIC
AMERICAN SUPPLEMENT, No. 1012. Price 10 cents.
To be had at this office and from all newsdealers.

SMITH'S ROLLER
Spring Seat Post

All Sizes, 3/8 to 1 3/16.
Price \$2.50.

GIVE HEALTH
SENT ON TRIAL.
Write, and We'll tell all
about it.

JOS. N. SMITH & CO.
30 Larned Street,
Detroit, Mich.



At 1/4 Price Bicycles, Watches, Guns, Buggies, Harness,
Sewing Machines, Organs, Pianos, Safes, Tools,
Scales of all varieties and 1000 other articles.
List free. **CHICAGO SCALE CO., Chicago, Ill.**

ONLY WATER MOTOR
that can be tilted or adjusted
in any direction while running.
With 12 in. Polished Brass Fan and
Brass Guard, retail price, \$14.40
cash; or with 30 in. Ceiling or Fly
Fan, retail price, \$20.00 cash.
Agents wanted everywhere.
A. ROSENBERG CO.
Office 629 N. Carey St.
Baltimore, Md., U. S. A.



Pretty near a
WHOLE FAMILY
(406 lbs.)
on an
Eclipse



America's Strongest Bicycle.
They Stand the Test.

Send stamp for Art Catalogue telling all about above
test and others equally wonderful. Eight Models
\$50, \$60, \$75, \$100.

The FARROW
AUTOMATIC BRAKE and COASTER.

The greatest improvement in cycles since the ad-
vent of pneumatic tires. Perfect control of wheel;
coasting without lifting feet from pedals; increased
safety, increased pleasure.
Write for particulars of this most valuable and
salable device. **AGENTS WANTED.**

ECLIPSE BICYCLE COMPANY,
Box X. ELMIRA, N. Y.

THE PARK SPRING SADDLE
UNEQUALLED FOR EASY RIDING.

With the Park spring, the rider is relieved
from injurious jar, which is the
only unpleasant feature about
cycling. On receipt of price, we
will ship to any address a saddle
suitable for your weight, with the privilege of return-
ing it after a week's trial, if not entirely satisfactory;
you to prepay express charges, and upon receipt of saddle
will at once refund money. Send for catalogue free.
Wanted agents in every town, men or women. Send for
particulars. **C. Z. Kroh & Co., Toledo, Ohio.**



The Automatic Neostyle



produces 2,000 perfect copies
from one original writing or
typewriting, 30 copies per min-
ute. The machine is easy to
operate, as nearly all the work
is done automatically. Refer-
ences to leading concerns now
using it.

NEOSTYLE CO., 96-102 Church Street, New York City

IMPROVED WASHBURN'S PATENT
EYE GLASS HOLDER AND PENCIL HOLDER.



An Eye Glass Holder that
is handy and reliable. No
pins to bend or catch in
clothing. Can be attached
to lapel, pocket, or any other
convenient place. You
will know where to find a
lead pencil when you want
it in a hurry if you attach one
of these pencil holders to your
vest pocket. Sample of either,
by mail, 10c. Illustration catalogue free.
AMERICAN RING CO., Dept. S. A., Waterbury, Conn.

JESSOP'S STEEL THE VERY BEST
FOR TOOLS, SAWS, ETC.
Wm. Jessop & Sons, Ld., 91 John St., New York

PRINTING INKS
The SCIENTIFIC AMERICAN is printed with CHAS.
RNEU JOHNSON & CO.'S INK, Fifth and Lombard
Sts., Philadelphia, and 47 Rose St., opp. Duane, New York