

SCIENTIFIC AMERICAN

[Entered at the Post Office of New York, N. Y., as Second Class matter. Copyright, 1896, by Munn & Co.]

A WEEKLY JOURNAL OF PRACTICAL INFORMATION, ART, SCIENCE, MECHANICS, CHEMISTRY, AND MANUFACTURES.

Vol. LXXIV.—No. 11.
ESTABLISHED 1845.

NEW YORK, MARCH 14, 1896

[\$3.00 A YEAR.
WEEKLY.]

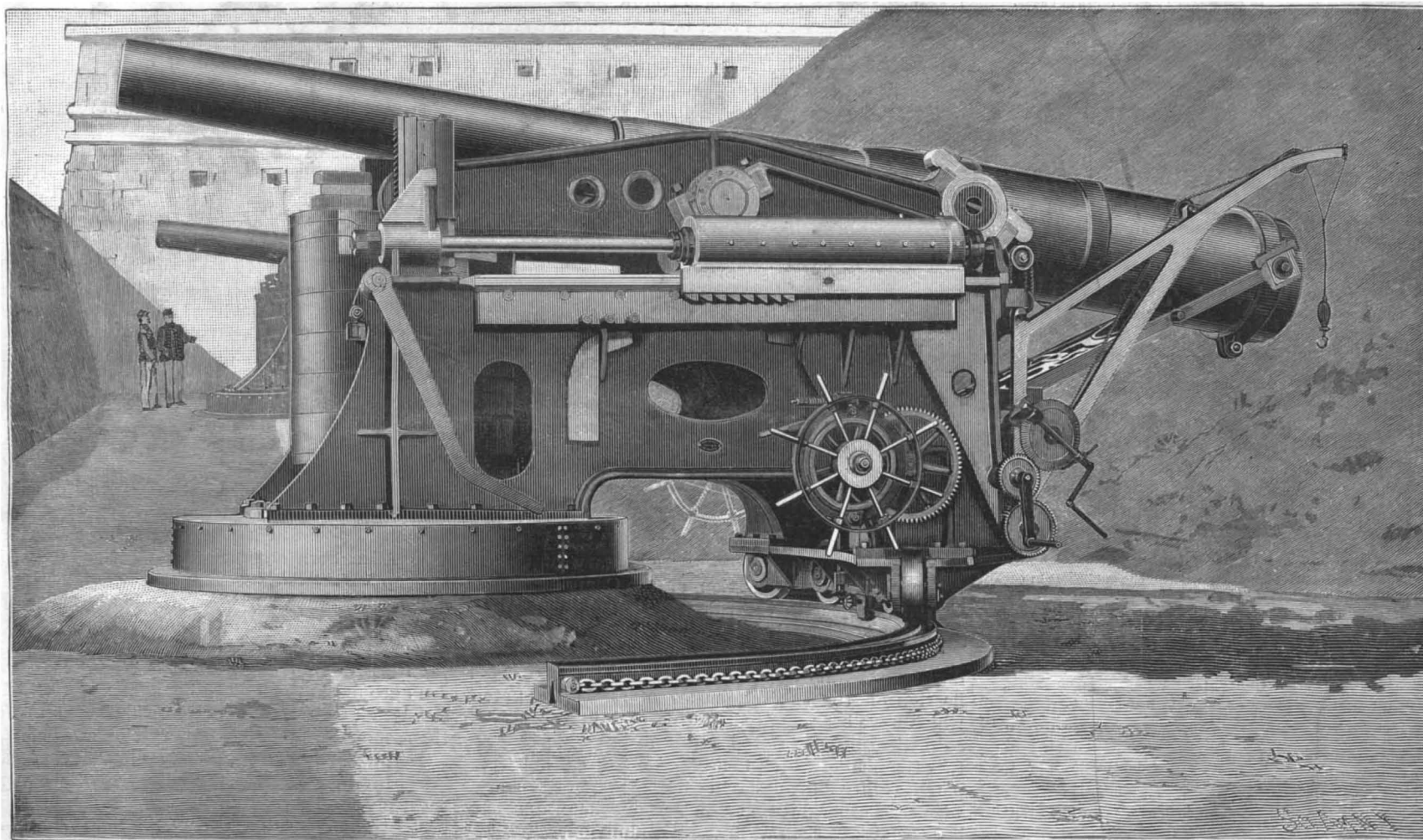

THE BUFFINGTON-CROZIER BARBETTE DISAPPEARING CARRIAGE LOWERED.

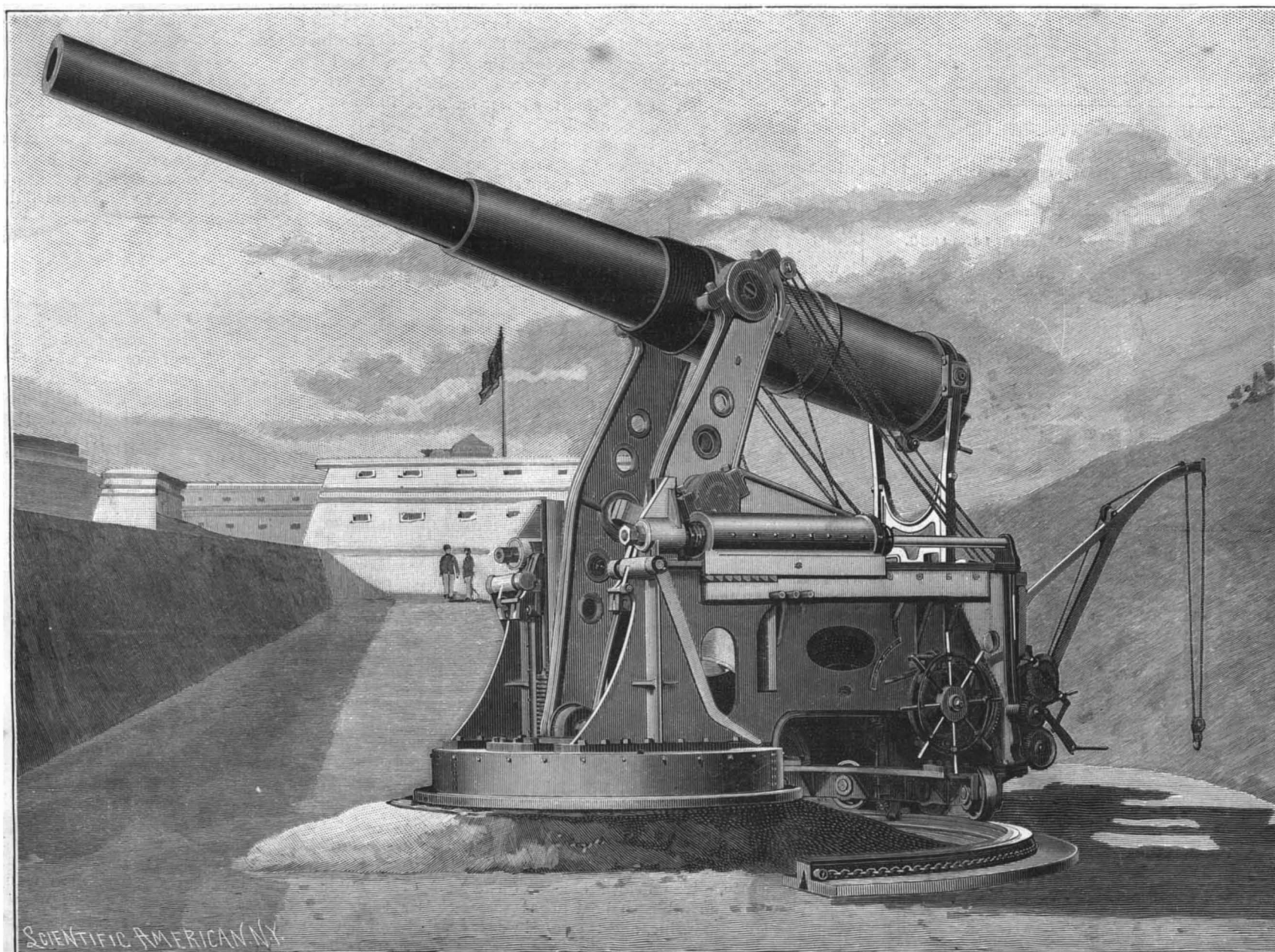

THE DEFENSE OF NEW YORK HARBOR—EIGHT INCH GUN MOUNTED ON BUFFINGTON-CROZIER DISAPPEARING CARRIAGE AT FORT WADSWORTH.—[See p. 167.]

Scientific American.

ESTABLISHED 1845.

MUNN & CO., Editors and Proprietors.

PUBLISHED WEEKLY AT

No. 361 BROADWAY, NEW YORK.

TERMS FOR THE SCIENTIFIC AMERICAN.

(Established 1845.)

One copy, one year, for the U. S., Canada or Mexico. \$3 00
One copy, six months, for the U. S., Canada or Mexico. 1 50
One copy, one year, to any foreign country belonging to Postal Union 4 00

MUNN & CO., 361 Broadway, corner of Franklin Street, New York.

The Scientific American Supplement

(Established 1876)

is a distinct paper from the SCIENTIFIC AMERICAN. THE SUPPLEMENT is issued weekly. Every number contains 16 octavo pages, uniform in size with SCIENTIFIC AMERICAN. Terms of subscription for SUPPLEMENT, \$5.00 a year, for the U. S., Canada or Mexico. \$6.00 a year to foreign countries belonging to the Postal Union. Single copies 10 cents. Sold by all newsdealers throughout the country. See prospectus, last page.

Building Edition of Scientific American.

(Established 1885.)

THE BUILDING EDITION OF THE SCIENTIFIC AMERICAN is a large and splendidly illustrated periodical, issued monthly, containing floor plans and perspective views pertaining to modern architecture. Each number is illustrated with beautiful plates, showing desirable dwellings, public buildings and architectural work in great variety. To architects, builders and all who contemplate building this work is invaluable.

Export Edition of the Scientific American

(Established 1878)

with which is incorporated "LA AMERICA CIENTIFICA E INDUSTRIAL," or Spanish edition of the SCIENTIFIC AMERICAN published monthly, uniform in size and typography with the SCIENTIFIC AMERICAN. Every number contains about 50 pages, profusely illustrated. It is the finest scientific, industrial export paper published. It circulates throughout Cuba, the West Indies, Mexico, Central and South America, Spain and Spanish possessions—wherever the Spanish language is spoken. THE SCIENTIFIC AMERICAN EXPORT EDITION has a large guaranteed circulation in all commercial places throughout the world. \$3.00 a year, post paid to any part of the world. Single copies 25 cents.

The safest way to remit is by postal order, express money order, draft or bank check. Make all remittances payable to order of MUNN & CO. Readers are specially requested to notify the publishers in case of any failure, delay, or irregularity in receipt of papers.

NEW YORK, SATURDAY, MARCH 14, 1896.

Contents.

(Illustrated articles are marked with an asterisk.)

Aluminum, corrosion of. 170
Art pottery. 168
Battery, boron. 164
Beards and bacteria. 171
Cannon, horse power of a. 170
Celery oil. 161
Defense of New York Harbor*. 170
Draughtsmen, an opportunity for. 163
Electric progress in China. 167
Electricity in dentistry. 166
Electric light buoy*. 169
Electric mains. 164
Engines, gas and oil. 162
Games, the Olympian. 162
Gas flames, carbon monoxide in. 166
Glass, boring (6758). 172
Guns, disappearing, for New York harbor*. 161
Heat in Australia, the. 170
Inventions, recently patented. 172
Kidney, calculus in the. 165
Kite flying, experiments in*. 171
Lanterns, optical projection*. 165
Latitudes, high, reached. 163
Mannocitin. 166
Maritime lights, inaccessible*. 169
New York harbor, guns for defense of*. 161
Oil lantern, a lighthouse*. 169
Of cassia. 170
Patents granted, weekly record of. 173
Patent Office legislation, needed. 162
Photographic slides. 165
Pictures under artificial light. 170
Planting check row device, Australia. 164
Polar expedition, Nansen's*. 163
Potatoes, phenomenal growth of. 166
Railroad collision, a curious*. 168
Rubber shoes sixty years ago. 167
Scars, prints of*. 168
Science notes. 170
Temperatures, low, work at. 163
Thill coupling device, Price*. 164
Vehicle hub device, McQuivay's*. 166
Wagon axles, nuts on. 166
Wind storm, a phenomenal. 162

TABLE OF CONTENTS OF SCIENTIFIC AMERICAN SUPPLEMENT

No. 1054.

For the Week Ending March 14, 1896.

Price 10 cents. For sale by all newsdealers.

I. ARCHAEOLOGY.—Pompeian Surgery and Surgical Instruments.—By N. SENN, D. Ph.D.—A very curious department of archaeology.—Description and illustration of surgical instruments found in the Roman city.—2 illustrations. 16842
II. ASTRONOMY.—Magnetic Influence of the Planets.—By ARTHUR SCHUSTER, in Nature.—Examination of the possible magnetic relations of the earth and planets. 16849
III. AUTOCARS.—Mechanical Road Carriages.—By W. WORBY BEAUMONT.—Lecture I, continued.—Continuation of this important series of lectures, with numerous illustrations of the older road carriages as an introduction to the modern art of motocyeling.—12 illustrations. 16846
IV. BALLISTICS.—The Polarizing Photo-chronograph Applied to the Measurement of the Velocity of Projectiles.—A most ingenious apparatus for determining the velocity of projectiles, employing what is practically a photographic shutter without lens.—8 illustrations. 16850
V. CHEMISTRY.—Apparatus for the Estimation of Sulphur in Iron.—By E. J. READ.—Apparatus for determining sulphur by evolution from the metal treated with acid.—1 illustration. 16844
Explosive Mixtures of Gases With Air.—A valuable paper on this important subject. 16844
VI. ELECTRICAL ENGINEERING.—The Air Chamber Trolley Conduit.—An underground trolley system on the diving bell principle to secure the leads from interference by penetration of water.—2 illustrations. 16843
Electro-Magnets for Lifting Purposes.—An interesting utilization of magnetic traction in the lifting of heavy weights.—4 illustrations. 16849
VII. MISCELLANEOUS.—The Carnival at Nice.—A curiosity of the carnival in the Mediterranean city.—1 illustration. 16842
Theatrical Science.—The Mask of Balsamo.—An interesting example of stage magic of the more elaborate description fully described and explained.—1 illustration. 16842
Electrical Notes. 16845
Engineering Notes. 16845
Miscellaneous Notes. 16845
Selected Formulae. 16844
VIII. PHYSICS.—Black Light.—An interesting note on cathodic rays.—By D. ARSONVAL, the great scientist. 16852
Miscellaneous Notes on India Rubber. 16844
On the Rays of Roentgen.—By Prof. E. SALVIONI.—Prof. Salvioni's paper on the X rays, and results of his experiments with the cryptoscope. 16849
IX. POLITICAL SCIENCE.—The United States and Cuba.—The relations between the United States and Cuba.—Notes on the operations of the war in the island.—1 illustration. 16839
X. RAILROAD ENGINEERING.—The Year 1895 in the Mechanical Department of the Railroad Industry.—A valuable review of the titular subject, with application to the United States. 16848
XI. SOCIAL SCIENCE.—The Industrial Revolution in Japan.—By WILLIAM ELLERY CURTIS.—A very valuable article on the present status of Japan and the life of the people there and the recent changes in customs. 16840
The Science of Social Statistics.—An interesting lecture by United States Commissioner CARROLL D. WRIGHT, with interesting statistics and table. 16840
XII. TRAVEL AND EXPLORATION.—Abyssinia.—Notes on the scene of the Italian and Abyssinian war, with portraits of the Emperor and Empress of Abyssinia.—2 illustrations. 16854
Descent of the Abyss of Gaping Ghyll, England.—A curious natural well or cavern in Yorkshire, England, described and illustrated.—3 illustrations. 16853

NEEDED PATENT OFFICE LEGISLATION.

Year by year the lack of ample appropriations to provide a sufficient force at the Patent Office for the rapid conduct of business becomes more manifest and should lead all legislators interested in the welfare of their country and the progress of invention to regard this most useful branch of the government with liberal ideas of its needs. Inventors, we presume, as a rule, do not appreciate the power they might have in shaping good legislation for their interests by personally urging upon the respective representatives and senators from their sections of the country the necessities for more liberal laws regarding patents and the enlargement of the Patent Office facilities.

In view of the vast number of patents already issued and the increasing number of applications now being made each week, the new bill introduced in the House of Representatives and Senate at Washington during the present session, and known as a bill "To establish a classification division in the United States Patent Office," is most timely and is a step in a direction which will be of great service and utility to inventors in the future. It has the unanimous approval, not only of the officials of the Patent Office, but of every sincere friend of the inventor, and has been favorably acted upon by the committees in the House and Senate. We hope there will be no unnecessary delay in its becoming a law, and that there will be no pruning of the amounts asked for.

The bill provides for the establishment in the Patent Office of a new division, to be called the "Classification Division," to be managed by one primary examiner, having a salary of \$2,750 per year; two first assistant examiners, each \$1,800 per year; two second assistant examiners, at \$1,600 per year; three third assistant examiners, at \$1,400 per year; and thirty-six fourth assistant examiners at \$1,200 per year; and clerks, copyists and messengers—in all equal to \$64,590. Each person is to be appointed by the Secretary of the Interior, upon the nomination of the Commissioner of Patents, subject to the rules and regulations of the Civil Service Commissioner.

"The Commissioner of Patents shall assign to this division the duty of preparing a philosophical classification of the subject matter of all letters patent which have been granted in this and in the foreign countries, and of printed publications which constitute the field of search in ascertaining the novelty and patentability of applications for patents, together with such other duties having relation hereto as may be considered necessary by the commissioner."

Not only will the methodical and uniform classification of the letters patent issued by the United States be effected, but also the patents of foreign countries and printed publications; this certainly will be a great gain, by enabling inventors or their solicitors, when making searches in regard to the novelty of inventions, to do so on an equal footing with the examiners of the Patent Office, in addition to affording the latter facilities for the quicker disposition of applications.

When such legislation is demanded by all conversant with the needs of the Patent Office and is urged by the officials connected therewith, there should be no doubt about its being enacted. The sooner the better. We shall allude in a future number to another bill, in which several important amendments to the existing law are proposed.

A PHENOMENAL WIND STORM.

The wind record for February in the city of New York and vicinity was very remarkable, and so far, March, which is considered the most blustering month of the year, bids fair to sustain its reputation. The number of miles traveled by the wind in New York City in February was 14,402, or 6,167 miles more than in February, 1894, and 5,595 miles more than in the same month in 1895. This record is also 6,657 miles more than in March, 1894, and 3,722 more than in March, 1895. Local forecaster Dunn stated to our representative that the gale which struck the city on Wednesday, March 4, made a new record for New York; for, at 12:40 P. M., the wind attained a velocity of 82 miles per hour for one minute, the next highest record in this storm being 80 miles an hour for one minute. The best record for five minutes was at the rate of 72 miles (average) per hour.

From noon on Monday to noon on Tuesday—the twenty-four hour record, as it is called—the wind traveled 1,147 miles (or about twice the distance traversed by an ocean liner in the same period, or more than a day's run of an express train); from noon on Tuesday, March 3, to noon of Wednesday 875 miles; and in the next twenty-four hours, 1,076 miles. This great northwest windstorm played havoc with various structures and with commerce and pedestrians. No sailing craft came into port by way of Sandy Hook, and the steam craft made progress with extreme difficulty. The health officer of the port of New York was not able to board the steamer Kaiser Wilhelm I at quarantine, and the vessel was compelled to anchor.

The ferryboats made their landings after long delays. A woman was blown from a train near Little

Ferry, N. J., and similar accidents occurred elsewhere; men were also blown from boats. A platform was blown upon a track of a railroad and an engine was wrecked in consequence of running into it. Two freight cars of the New York & New Haven Railroad were unroofed. Fences, windows and roofs in localities in the path of the storm suffered severely. But it was in New York City that the storm was particularly severe. Around the high buildings the wind raged and howled, making progress against it well nigh impossible. In some office buildings two men were stationed by each door simply to open it against the pressure of the wind. Some pedestrians were even thrown down, and one man was blown from his truck when the storm was at its height, and walking in the teeth of the wind was very exhausting. It was with difficulty that a hat could be kept on the head. On the whole, New Yorkers suffered one of the most unpleasant experiences since the great blizzard of March 12 and 13, 1888.

NEW YORK HARBOR.

The harbor of New York has recently been the scene of an unusual number of maritime disasters. The St. Paul last month ran ashore at a point but a few miles from its mouth, the Campania on the same occasion is said to have narrowly escaped a like fate, and although the St. Paul escaped without structural damage, her wrecking bill must have been very large, and the loss of her services, due to detention from sailing, and the expense of dry docking, required by the underwriters before she could be admitted as a risk for insurance, represent a large sum of money. Her stranding was due to fog. But a few days ago, on Saturday, February 29, a fog spread over the waters of New York Harbor, and an unprecedentedly bad record was made for the disasters of a single day. On this particular day the French steamer La Bourgogne ran into the Atlas Line ship Ailsa, both outward bound, the latter sinking in deep water and the French ship returning badly damaged. The George W. Clyde of the Clyde Line was run into by the Guyandotte of the Old Dominion Line, and was beached badly damaged. Just below the Narrows the American Line steamship New York ran aground in the fog, backed off and worked along slowly to again go aground more firmly than before, so that some days elapsed before she escaped. These were the principal disasters of a memorable day.

The number and variety of these disasters render the necessity of furnishing New York Harbor with the best available system of marine lighting an imperative duty. To procure a light that will be available during a fog is well nigh impossible. We show on another page the present system of lighting the channel, which is efficient for night service, and which, under ordinary conditions, serves to light up the channel as if it were an avenue.

The recent accidents that we have mentioned were in no way due to any defect in the present system of lighting the harbor, as most of them occurred in the fog during the day time. There is much, however, that remains to be done to prevent such accidents, not only in the way of producing an efficient light for use during fogs, but in furnishing vessels and lighthouses with efficient fog signals.

The main ship channel of New York Harbor pursues a particularly devious course. On Sandy Hook, on the mainland of New Jersey and on Staten Island there are established range lights and screens for enabling the lines of the channels to be followed, the main ship channel being the longest and most winding. In the daytime long lines of buoys, red and black, are ranged along the sides of the channels, with channel and danger buoys also, so that once the long lane is entered, it can be followed without the least trouble, if the buoys can be seen. Until recently the lights on shore were the only guides that were maintained for the mariner's use at night.

In the article on another page we describe the very remarkable electrically lighted buoy installation which, in face of some opposition from the conservative element, has been placed along Gedney's Channel, lighting over a mile of its length. A ship now makes the night run through the outer lines of the bar, where she is furthest from the range lights on shore, by a system of lighted buoys exactly comparable to street lamps.

THE OLYMPIAN GAMES.

In the month of April, historic Athens, the scene of so many notable athletic contests, will be invaded by the athletes of the modern world, and the sports of the ancient Greeks will be resurrected, and modern games will also be introduced. Two years ago, at the Paris Athletic Congress, it was decided to revive the "Olympian Games," which first took place in the year 776 B. C., for it was then that the regular catalogue of Olympic victors begins. The Olympian Games were the greatest of the four Panhellenic festivals of the ancient Greeks. They were celebrated at intervals of four years, in honor of Zeus, in a sacred inclosure in the plain of Olympia, a valley in Elis, Peloponnesus, Greece. The importance of the games was so great

that the Greeks computed time by them. The period of four years between one celebration and the next was called an "Olympiad." The games had also the privilege of suspending wars during the time necessary to go to the festival and return. Since the eighteenth Olympiad, in 708 B. C., those who had shown themselves qualified entered in the lists for the javelin contest. The best four champions in this trial presented themselves for the foot race, which eliminated one contestant. There then remained three for the quoits and two for wrestling. A crown of wild olive was the reward of the victor. When he returned to his native city, the walls were torn down to give him entrance; he was borne in a triumphant procession, and he was given freedom from taxes. The Olympic Games were only abolished by Theodosius in A. D. 394. The contests were all held in the stadium, which was so constructed that fifty thousand spectators could find a place around the arena. The stadium is 656 feet long and 100 feet wide, and there are twenty-five ranges of seats. The seats, steps, etc., are built of stone from the Piraeus and of Pentelic marble. Thanks to the munificence of a wealthy Grecian gentleman, the work of repairing the stadium was done. In the SCIENTIFIC AMERICAN for January 11, 1896, the work of restoring the ancient stadium is illustrated.

In one respect the coming games will be remarkable, as women may now compete in the arena for athletic honors, according to the old Grecian custom. The games will inaugurate a series of international contests, the next being held in Paris in 1900. The Olympian Games will begin April 6, the seventy-fifth anniversary of the proclamation of Greek independence, and will continue for five days. The games will be under the presidency of H. R. H. the Crown Prince of Greece. The games will consist of athletic sports, including:

Running Contests.—Flat races for distances of 100, 400, 800, and 1,500 meters; also a hurdle race of 110 meters, under the rules of the Union des Sociétés Françaises de Sports Athlétiques. Special cross country race, from Marathon to Athens, a distance of forty-two kilometers, for the cups offered by Mr. Michel Bréal. The winning post for this race will be at the Panathenaic Stadium restored through the munificence of the Hellenic citizen Georges Avéroff. Competitions also in long and high jumps, pole jumps, putting the weight and disk. There will also be gymnastic competitions; fencing and wrestling, also foil, saber, and sword exercises for amateurs and professionals. Wrestling—Roman and Greek styles.

Shooting with any kind of rifle (military or otherwise), distance 200 and 300 meters; and with revolvers.

Nautical sports will include yachting (supplementary programme). Steam yacht race under the rules of the "Cercle de la Voile de Paris," distance 10 miles. Sailing races under the English Yacht Racing Association's rules and tonnage regulations. 1. For yachts of not more than 3 tons (in two sections, if necessary), distance 5 miles. 2. For yachts from 3 to 10 tons, distance 10 miles. 3. For yachts from 10 to 20 tons, distance 10 miles. 4. For yachts of more than 20 tons, distance 10 miles. Races will also be arranged for native sailing vessels and seamen. Rowing, single sculler, 2,000 meters over a straight course (skiffs); double scullers, over a straight course, for yawls and outriggers; four oar race, over a straight course, for yawls. A special race will be arranged for men-of-war crews. The rules will be as those of the Italian Rowing Club. Swimming.—Long and short distance races, for distance varying from 100 to 1,000 meters. There will also be water polo competitions.

Cycling.—Short distance races. 2,000 meters on the track without pace makers; 10,000 meters on the track without pace makers. 100 kilometers on the track with pace makers. Twelve hours' race on the track with pace makers.

Lawn Tennis.—Single, double (Rules of the All England Lawn Tennis Association). Cricket (under the rules of the Marylebone Cricket Club). Football (Rugby and Association).

M. RAOUL PICTET, who has done much original chemical work at low temperatures, suggests that by making use of low temperatures syntheses may be obtained which would be otherwise impossible. In many chemical operations the heat generated so raises the general temperature of the bodies acted upon that all control over the combination is lost. At very low temperatures, however, all chemical action ceases. By choosing the right temperature, therefore, reaction between chemicals may be made as slow as desired. By this means M. Pictet has effected combinations that are impossible at ordinary temperatures.

NANSEN'S POLAR EXPEDITION.

As our readers are aware, the news has been published in the daily press to the effect that a report from Irkutsk in Siberia has been received, stating that Nansen had discovered the North Pole, and was now on his way home. The report has not been definitely confirmed. We present our readers a map of the North Polar region, believing that it will be of interest to recall some of the particulars of his expedition.

We have in several of our SUPPLEMENTS described the pathetic starting of the expedition from Christiania, the little ship passing close by the explorer's home, where his wife, dressed in white, and the companion of many of his trips, standing on the shore, saw the last of her husband.

The theory on which the expedition was based was that ocean currents exist whose direction is from the islands of New Siberia across the North Polar region to Greenland. The Jeannette sank off these islands and it was claimed that relics of the Jeannette were picked up on the shores of Greenland. Other drift relics were cited as additional proofs of these currents. In the face of this theory there were most emphatic denials, not only of the existence of such currents, but even of the authenticity of the finding of the relics.

Basing his expedition on this theory, Dr. Nansen had a special ship built for his trip, the Fram. She

her sloping sides and bottom. She was very strongly built, being planked with double layers of oak 3¼ inches and 4½ inches thick, sheathed again with ice planking varying from 3¼ inches to 6½ thick. The ceiling was in alternate strakes 4½ inches and 8½ inches thick. The enormous mass of timber for so small a vessel, in conjunction with her shape, seemed enough to make her stand anything. The screw and rudder were arranged so that they could be raised into a well for protection if desired. The ship was 101 feet 6 inches long, displacing 800 tons at 15 feet 6 inches draught with 3 feet 3 inches freeboard. Her carrying capacity was put at 380 tons and she carried five years supply of provisions.

Her crew consisted of eleven men in addition to Dr. Nansen, and they departed prepared for an absence of three to five years. The ship was to coast along the northern shores of Europe until she reached the vicinity of the New Siberian Islands; here she was to strike north, depending largely on ocean currents to carry her along. The course would carry her past the North Cape and then approximately along the 70th and 80th circles of latitude until at or about the 150th parallel of longitude east from Greenwich, and just north of Bennett Island, the course would be changed to the north. Hence the explorer hoped to pass by the pole, to work down along the east coast of Greenland and thence to the east back to Christiania. In many ways it is the most interesting of the attempts yet made to reach the pole. The specially built ship, the personnel of those who manned her and the unselfishness of her commander gave an element of the romantic to the whole. The explorer is said to have had the smallest and least comfortable cabin in the ship.

Nansen's previous work in the Arctic indicated his ability to use all the possible resources of the region for his work. He utilized skoes or Norwegian snow-shoes in traversing the Greenland ice caps, and in his book on his Greenland expedition will be found a singularly interesting account of these aids to snow travel. It is to be hoped that his resourceful mind will prove equal to the task he has assigned himself. He departed on June 24, 1893, and the present day seems too soon for him to be heard from.

As an interesting appendix, we print a table of the most northerly points attained by Arctic voyagers. The figures will be impressive in showing how slow the advance to the north is, and how little has been gained since the days of Henry Hudson. The table is taken from General A. W. Greely's work, "Hand-book of Arctic Discoveries."

An Opportunity for Draughtsmen.

The Municipal Civil Service Board, of this city, will soon hold examinations for the positions of computer and topographical draughtsman in the parks and annexed district. It has been difficult to get a sufficient number of candidates for either of these positions, and quite a number of vacancies exist in consequence. The salaries paid the computers range from \$900 to \$1,200 per annum. The salary of draughtsman is \$1,200. The board is anxious to receive applications at once, and will hold its examinations as soon as a sufficient number of applications have been received.

Blanks may be procured at the office of the Civil Service Board, Criminal Courts building.

THE telephone, according to the Electrical Engineer, has got a footing in Iceland. It is said that an American is laying a line between Reykyavik and Akureyri, at a cost of 100,000 kr. (\$27,000). It is also reported that an Englishman has submitted to the Althing a proposal for a telegraph cable between Iceland and the Shetland Islands.

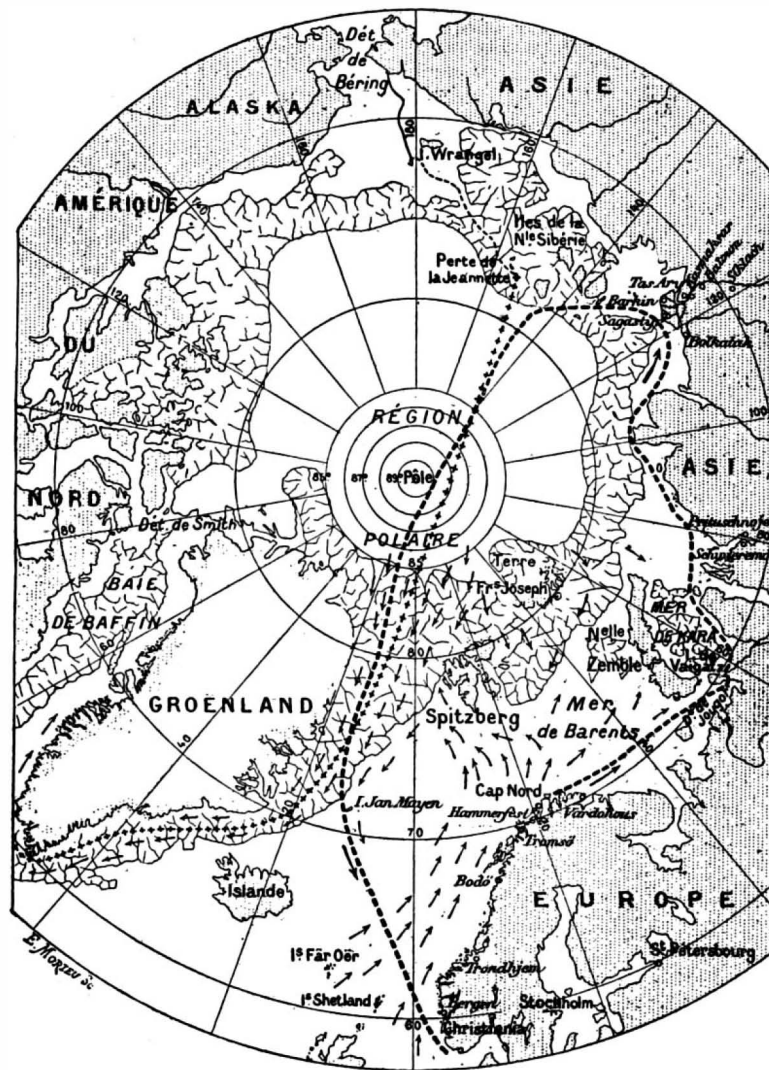

DR. NANSEN'S PROPOSED ROUTE. THE STARRED LINE SHOWS COURSE OF DRIFTWOOD FROM THE JEANNETTE.

was a three masted schooner in rig, with engine and screw, rather of the auxiliary type. With a consumption of 2¾ tons of coal a day the Fram would develop a speed of 6 miles an hour, the idea being to use sail whenever possible and economize coal for use in emergencies. She was built with a very round bottom and her keel came even with the outer planking, so that nothing was presented for the ice to take hold of. The hopes were that if caught between opposing floes she would be lifted up bodily, the ice sliding in under

EASTERN HEMISPHERE.				
Commander.	Date.	North Latitude.	Longitude.	Locality.
William Barents.	July 14, 1594	77° 20'	62° E.	Near C. Nassau, Nova Zembla.
Ryp and Heemskerck (Barents' third voyage).	June 19, 1596	79° 49'	12° E.	North Spitzbergen.
Henry Hudson.	July 13, 1607	80° 23'	10° E.	Spitzbergen Sea.
J. C. Phipps.	July 27, 1773	80° 48'	20° E.	Spitzbergen Sea.
William Scoresby.	May 24, 1806	81° 30'	19° E.	Spitzbergen Sea.
W. E. Parry.	July 23, 1827	82° 45'	20° E.	Spitzbergen Sea.
Nordenskiöld and Otter.	September 19, 1868	81° 42'	18° E.	Spitzbergen Sea (highest by ship).
Weyprecht and Payer.	April 12, 1874	82° 05'	60° E.	Franz Josef Land (by Payer, highest land).
WESTERN HEMISPHERE.				
John Davis.	June 30, 1587	72° 12'	56° W.	West Greenland.
Henry Hudson.	June 20, 1607	73°	20° W.	Off East Greenland.
William Baffin.	July 4, 1616	77° 45'	72° W.	Smith Sound.
E. A. Ingfield.	August 27, 1852	78° 21'	74° W.	Smith Sound.
E. K. Kane.	June 24, 1854	80° 10'	67° W.	Cape Constitution, Greenland, by Morton.
C. F. Hall.	August 30, 1870	82° 11'	61° W.	Frozen Sea.
C. F. Hall.	June 30, 1871	82° 07'	59° W.	Greenland, by Sergeant Meyer.
G. S. Narces.	September 25, 1875	82° 48'	65° W.	Grinnell Land, by Adrich.
G. S. Narces.	May 12, 1876	83° 20'	65° W.	Frozen Sea, by A. H. Markham.
A. W. Greely.	May 13, 1882	83° 24'	41° W.	New land, north of Greenland, by Lockwood and Brainard.

AN ANTI-RATTLING THILL COUPLING.

The attachment for thill couplings or thill irons represented in the illustration is made principally of a single piece of spring wire, and is readily applied to any axle and any thill. The device exerts sufficient pressure on the eye of the thill iron to prevent rattling, and has a rolling tension on the forward face of the thill iron by which the shafts and thills will be balanced when the horse is attached, and which is designed to hold the thills upright or nearly so when the animal is disengaged therefrom. The improvement has been patented by Thomas Price, Itasca, Texas. Fig. 1 shows the application of the device, Fig. 2 representing it detached. The side members, curved forwardly and upwardly from the coils, support a friction roller shaped to receive the forward face of the thill iron, the spring or tension of the wire practically clamping the friction roller, and the ends of the wires being bent inwardly to form a journal for the roller. The

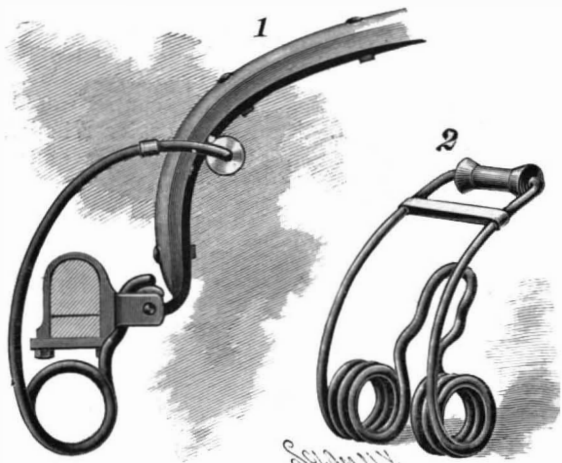

PRICE'S THILL SUPPORT.

tongue projecting upward between the coils is adapted to be carried up between the eye of the thill iron and the ears of the clip, where its concave under face rests on a cushion, preferably of leather, which rests upon and extends partially around the upper or rear face of the eye of the thill iron. The concavity of the tongue near its lower end is adapted for engagement with the axle or with the ends of the clip plate, the coils being beneath the axle. The device, as will be seen, is very simple, and may be quickly and easily applied.

IMPROVED GAS AND GASOLINE ENGINE.

The development of the gas engine since the Centennial Exhibition of 1876 is not less remarkable than the development of the steam engine in its earlier days. Improvements in gas and gasoline engines have succeeded each other with great rapidity, until this type of motor seems to have almost reached perfection.

We give an engraving of an engine of recent design made by P. F. Olds & Son, of Lansing, Mich., which is refined in both principle and construction. While the makers of this engine have adopted the four-cycle system, which has proved itself the most economical system of operation for gas engines, they have avoided all the complication of mechanism heretofore thought necessary for securing the valve motions, and have devised a new and very simple movement that accomplishes all that can be done by cams, lateral shafts and gearing, besides insuring the prompt opening and closing of the valves. This motion is secured by a plain eccentric on the main shaft, which reciprocates the alternating wheel operating the exhaust and compression valve. By throwing out the pawl which operates the alternating wheel, compression will be omitted and the engine can be turned to any point without the resistance of compression.

When gasoline is used as a source of power, the liquid is supplied to the engine from a tank located outside the building containing the engine, or, in case of small engines, the tank is located in the engine base, and by a simple de-

vice the gasoline is supplied to the engine as needed. Any surplus flows back to the tank.

The engine is arranged to use either an electric or hot tube igniter, the latter being constructed on an improved principle. Everything connected with the engine is arranged with a view to perfect safety. A very sensitive governor is employed which maintains a close regulation. The engine is nicely balanced, has large valve openings, ample bearings, straight line connections, and embodies all the improvements suggested by years of use of gas engines of various kinds, besides containing new features peculiar to itself.

The engine is made in two forms, horizontal and vertical, and is adapted to launches, which are also built by this firm.

Earthed Center Main.

In connection with possible dangers from the use of pressures of from 400 to 500 volts on the mains of electrical supply companies, I beg to hand you the following opinion from Mr. Musgrave Heaphy, who has recently discussed this matter with me. I need scarcely state that an opinion from this gentleman, who has such unrivaled advantages for estimating the dangers of electric power distribution, is worth serious attention.

It is commonly assumed in a three-wire system of supply, with center wire earthed, that it is impossible for there to be a difference of pressure on any premises wired on one side of the system greater than that between one of the outers and the middle wire. Mr. Heaphy points out that the full pressure may be brought into one house under certain conditions.

Assume two adjacent houses, the one connected to the positive and middle wire and the other to the middle wire and the negative; and let there be in the party wall: (a) an iron door frame, wall box or piece of shafting, etc., communicating between the two houses, insulated by dryness of the wall, by dry woodwork, or other means securing practical insulation. Or (b), leakage of water on to a portion of the party wall thus insulated.

Assume accidental connection between one of the outer mains, say through a defective flexible wire to one of the insulated pieces of metal, or to the damp portion of the wall. The leakage to earth will be probably too small to blow the fuses and so to disconnect the house.

Next assume an accidental leak on the other pole of the system in the adjacent house, say through the metal case of a switch or lampholder.

It is clear that, if the piece of insulated iron or damp wall be touched at the same time as the defective fitting, a shock due to the full pressure will be felt.

These conditions are not likely to occur often, for two earths on opposite poles have to be made concurrently and in adjacent houses, yet the risk is increased by the consumer's difficulty of detecting either leak except by a shock.

An obvious safeguard is to earth all isolated pieces of metal, but this does not get over the risk from walls which are damp locally. Iron barrel or concentric wiring, with the outer earthed, appear to be the safest methods of wiring under the conditions assumed. For with either it is probable that a single

leak would blow one of the fuses, and thus call attention to the defect.

In fact, if the middle wire be earthed, all iron work in buildings should be effectively earthed also.—Albion T. Snell, in the Electrical Review.

TENSION DEVICE FOR CHECK ROW WIRES.

A device to facilitate the stretching of check row wires at a uniform tension, no matter how often the wire may be shifted, or whether it is carried longitudinally of or across the field, is represented in the accompanying illustration. It has been patented by George B. Austin, of Dundas, Minn. It consists of a tension hook, the hook end of which is in twin form, that the wire to be stretched may be passed between its members, if desired, in making the attachment, and on the flat shank of the hook is a scale in inches, at the outer end of which an elongated guide yoke is secured to the shank. A spring is coiled around the



AUSTIN'S CHECK ROW DEVICE.

shank, one of its ends being secured thereto near the hook, while the wire of the spring at the opposite end is carried through a loose yoke and parallel with the scale, being also passed out and back through the fixed yoke, an eye being formed in the wire beyond the shank of the hook, and its inner end being secured to the loose yoke. The stake to which the guide wire of the check rower is usually attached is made to receive the eye of the device, one end of the wire to be stretched being attached to the hook, and when the wire is placed under tension the loose yoke moves over the scale and indicates in inches the amount of slack in the wire taken up, enabling the operator, when the wire is to be again stretched, to take up the same amount, whereby the wire will always be kept under the same tension, insuring the rows being in proper alignment.

Boron Battery.

The Electrical Engineer of November 29 describes this new Austrian battery, which consists of a plate of zinc and one of carbon covered with boron, the electrolyte being a solution of "manganese salt and other substances;" the voltage is 2.5 to 3, which is main-

tained for quite a long time; the cost of maintaining the battery is said to be one penny for a 10 hour run—but for what output is not stated. The novelty consists in covering the carbon plates with boron, which is done by immersing them at a high temperature in a bath of chloride or fluoride of boron, then in a solution of oxalate of platinum, after which they are heated to a red heat in an atmosphere of hydrogen. A plate so treated contains metallic boron in its pores.

A NEW industry in London is that of preserving eggs. The eggs have the shells removed, the white and yolk are then mixed together and the whole packed in hermetically sealed tins.

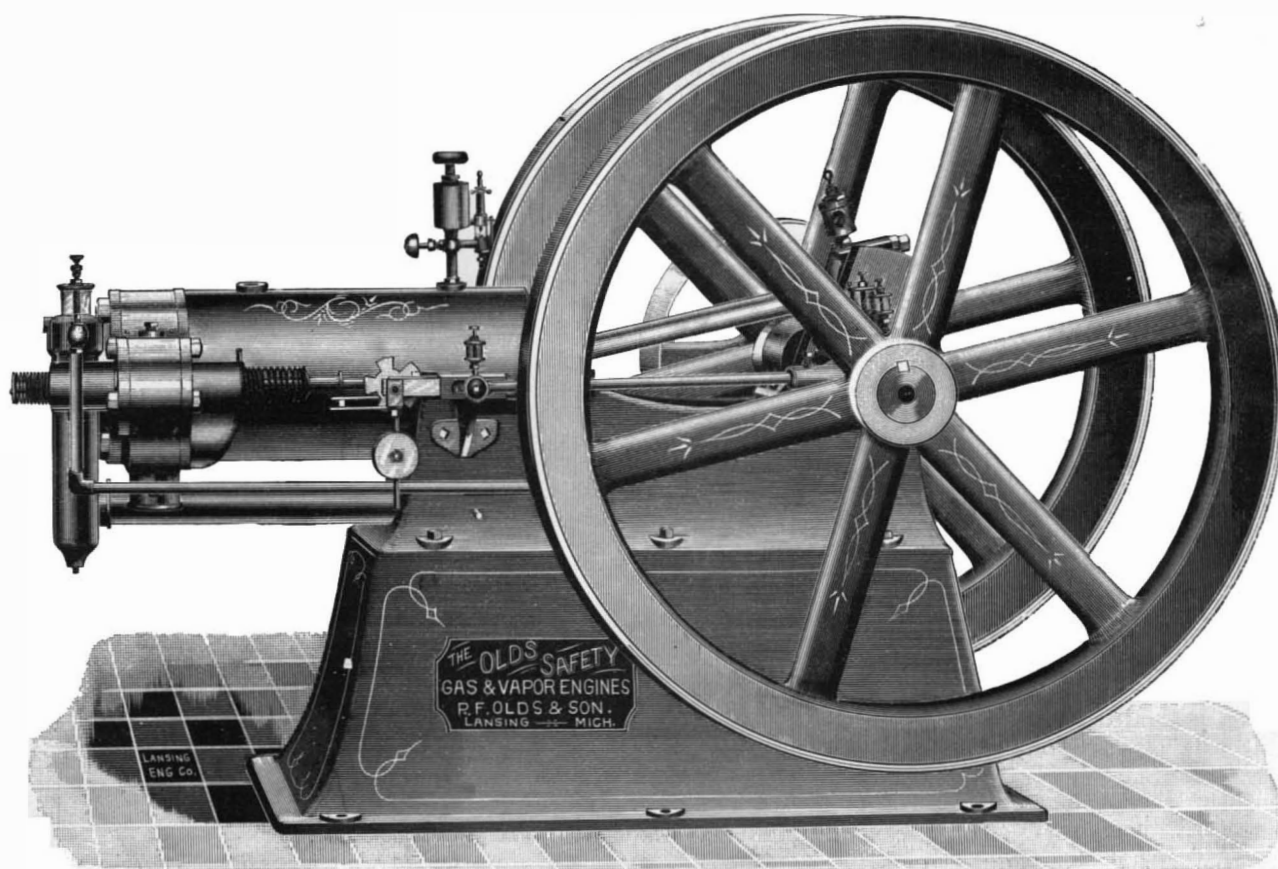

IMPROVED GAS AND GASOLINE ENGINE.

VARIOUS TYPES OF OPTICAL PROJECTION LANTERNS.

Owing to the variety and number of questions asked by our correspondents concerning the different types of optical lanterns for various uses, we publish herewith a number of illustrations showing the construction of lanterns adapted to different forms of gas, electric and oil lamps.

The importance of the optical lantern as a means of illustrating lectures on travel, art, science, or, in fact, any subject that may be brought before an audience, is now generally acknowledged, and educators have adopted it as an important factor in all branches of teaching. The development of the mechanical structure of the lantern has kept pace with the increasing demands for an instrument of accurate construction and ready adjustment. A wide departure has been made, as will be seen in the accompanying illustrations, from the older form of apparatus.

The apparatus here illustrated is manufactured by J. B. Colt & Company, 115 Nassau Street, New York. Fig. 1 shows the various adjustments of a new form

SS, thus providing for a forward and back adjustment. The hoods connecting the various attachments and shutting in the light are held in position on the condensing lens support, O. Lateral and vertical adjustments are afforded by the method of supporting the illuminator on the vertical posts. This arrangement affords a ready and accurate means for the centering of the light in the optical axis of the lantern.

Fig. 3 shows an improved automatic arc lamp. This lamp is provided with all necessary adjustments for the control of the carbons. Owing to the intensity of the light, it may be used in a room that is but partially darkened, and owing to the fact that the light emanates from approximately a point, it has optical advantages not found in other forms of artificial light. This lamp automatically maintains the arc in the optical axis of the lenses, and is therefore to be recommended for scientific demonstrations.

Fig. 4 shows an improved form of oil burner. This is constructed on the student's lamp principle, and is provided with a central draft and a positive wick

ingly convenient form of light for small exhibitions. In the illustration the polished reflector is cut away in order to show the mantle, D.

Fig. 8 illustrates the 100 candle power incandescent electric attachment. These lamps are specially constructed with a small carbon spiral, and are provided with an adjustable reflector fitted with a sliding and swivel adjustment at A, which enables the most advantageous centering of the light in relation to the lenses.

These lanterns are constructed in double or triple form, mounted one above another or side by side, as may be most convenient, for producing dissolving effects. When it is desired to use this lantern for scientific demonstrations the slide support, J, the bellows, C, and the objective lens and its supports are removed and the sliding rods, D D, give place to an optical bench on which may be supported a great variety of chemical and physical apparatus. A polariscope, a microscope, and a spectroscope may be applied to this lantern. The self-focusing arc lamp has been adapted

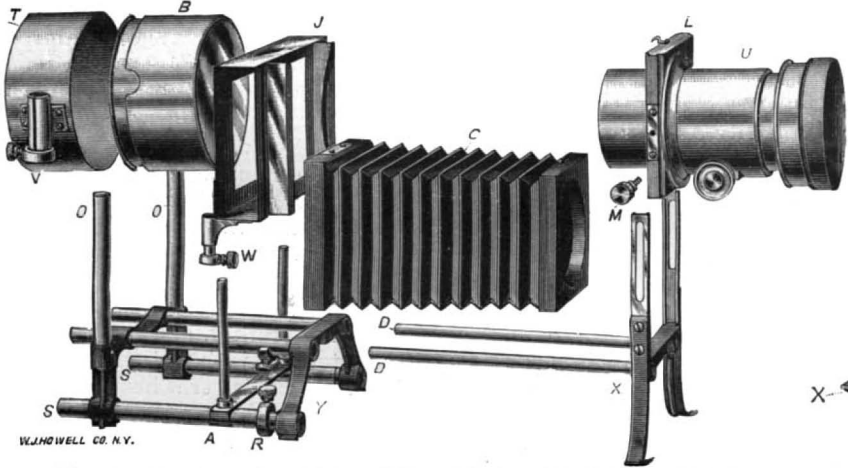

Fig. 1.—OPTICAL LANTERN, PARTS DISCONNECTED, TO SHOW ADJUSTMENTS.

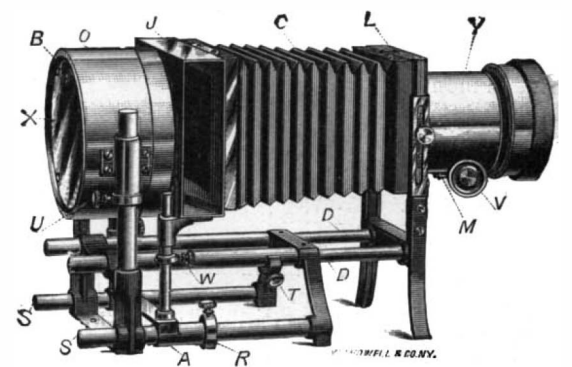

Fig. 2.—LANTERN WITH LIGHT REMOVED.

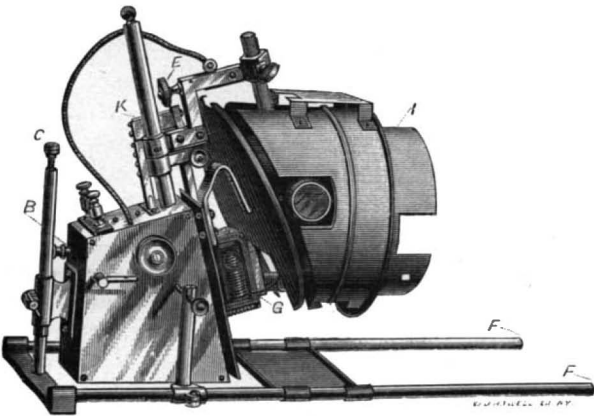

Fig. 3.—AUTOMATIC ARC LAMP.

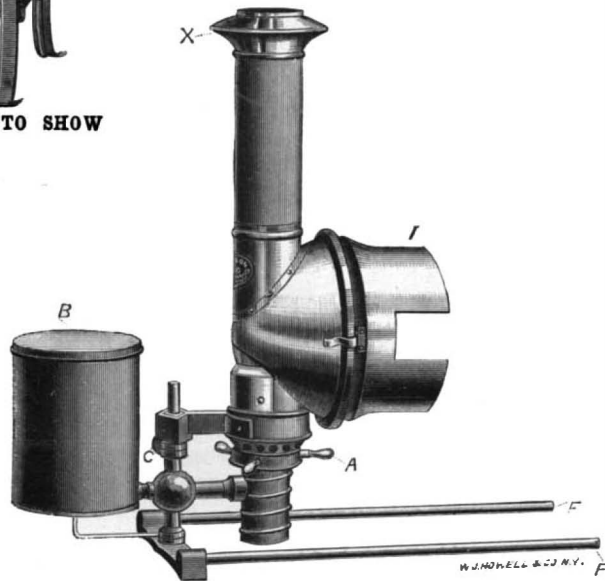

Fig. 4.—OIL BURNER.

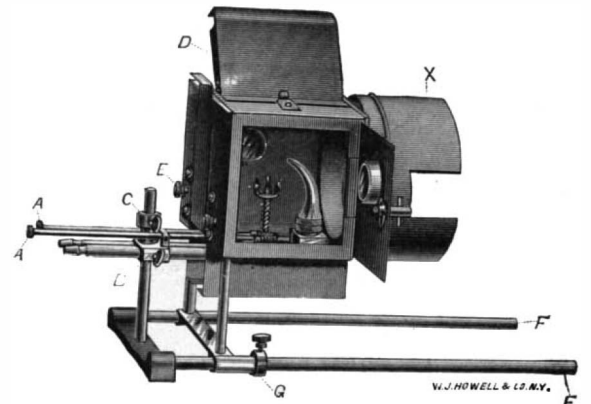

Fig. 5.—OXYHYDROGEN BURNER.

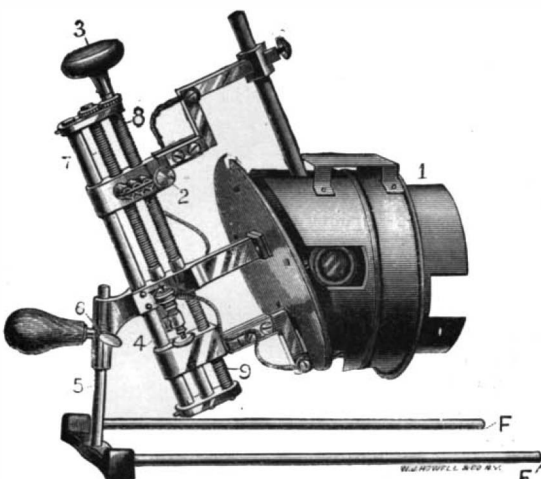

Fig. 6.—HAND FEED ELECTRIC LAMP.

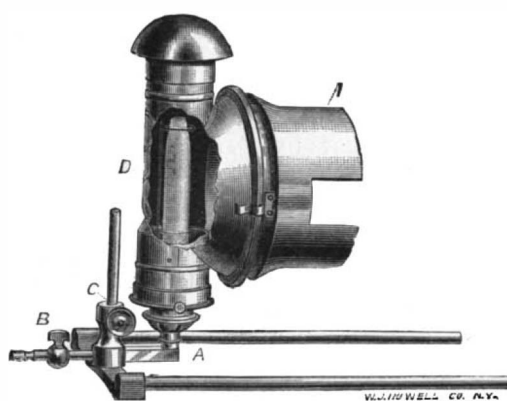

Fig. 7.—WELSBACH GAS BURNER APPLIED TO LANTERN.

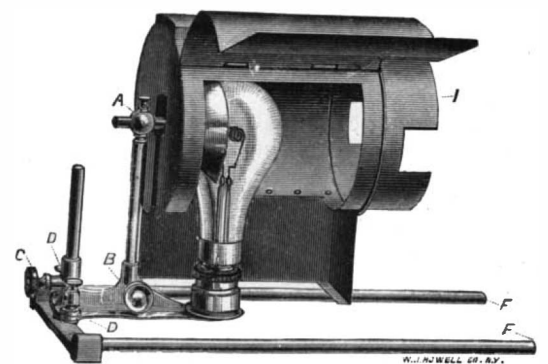

Fig. 8.—INCANDESCENT ELECTRIC LAMP APPLIED TO LANTERN.

of lantern called the Criterion. In this cut the various parts are disconnected in order to show more clearly its mechanical construction. It will be seen that all its parts are vertically adjustable, and that any of them may be removed without the use of tools; so that this lantern is perfectly adapted for physical, chemical, and optical demonstrations, as well as for the projection of pictures and diagrams.

Fig. 2 shows the apparatus and its various component parts in their normal positions, excepting the light or radiant. Of these six different forms are shown, any one of which may be used. This variety has been made possible by the perfection of three forms of electric attachment, and the adaptation of the Welsbach burner, with which the ordinary house gas is used, an improved form of oil lamp, and an oxyhydrogen attachment. In the construction of this apparatus the old form of light box or casing has given place to an entirely different construction, which consists of parallel rods, F F, with a cross piece on which is supported a vertical post, to which the various forms of radiant are attached. In each instance, the parallel sliding rods, F F, fit accurately the tubular bearings,

adjustment. This lamp gives unusually strong light, entirely free from smoke and disagreeable odors.

Fig. 5 illustrates a very perfect form of oxyhydrogen jet or burner, which is provided with mechanical screw rods, A A, for raising, lowering, and turning the lime and for controlling it at the proper distance from the tip of the burner. The metal hood is supported on vertical posts on the slide, O. This device enables the jet with its hood to be removed from the lantern without disarranging their relative adjustments.

In Fig. 6 is shown a hand feed electric arc lamp. Owing to the simplicity of construction of this apparatus, it can be sold at much lower price than the automatic form. In this case the carbons are fed by hand, by turning the insulated knob, 3, at intervals of three or four minutes, as the carbons are consumed. This lamp is provided with an adjustment so that it may be used on either the direct or alternating circuits, in either case maintaining the arc in the axis of the lantern.

Fig. 7 shows the adaptation of the Welsbach gas burner to the Criterion lantern. This is an exceed-

ingly convenient form of light for small exhibitions. In the illustration the polished reflector is cut away in order to show the mantle, D.

Fig. 8 illustrates the 100 candle power incandescent electric attachment. These lamps are specially constructed with a small carbon spiral, and are provided with an adjustable reflector fitted with a sliding and swivel adjustment at A, which enables the most advantageous centering of the light in relation to the lenses. These lanterns are constructed in double or triple form, mounted one above another or side by side, as may be most convenient, for producing dissolving effects. When it is desired to use this lantern for scientific demonstrations the slide support, J, the bellows, C, and the objective lens and its supports are removed and the sliding rods, D D, give place to an optical bench on which may be supported a great variety of chemical and physical apparatus. A polariscope, a microscope, and a spectroscope may be applied to this lantern. The self-focusing arc lamp has been adapted

Calculus in the Kidney.

Bartholow says that borotartarate of potassium is the first remedy for calculus in the pelvis of the kidney. A weak solution must be used for a long time, a strong solution being detrimental. The calculus of the kidney is formed from uric acid, and the neutral phosphatic alkaline salts are the best solvents of uric acid; therefore, to promote its elimination they would appear to be the best remedies to administer. The fruit acids are very useful, says the Buffalo Medical Journal; therefore abundance of fresh fruit would also be indicated for the relief and prevention of nephritic calculi.

ONE of the novelties exhibited at the National Cycle Show, at Crystal Palace, London, was a canopy which protected the rider from sun or rain. This canopy is like the ordinary buggy top, and is steadied by means of a small wheel at the back which runs on the ground.

Correspondence.

Carbon Monoxide in Gas Flames.

To the Editor of the SCIENTIFIC AMERICAN:

I saw the statement made by a correspondent of one of your contemporaries that the products of combustion of an ordinary gas flame used for light included carbon dioxide (CO₂), and that of a Bunsen burner carbon monoxide (CO), a very poisonous gas, and said correspondent wanted some chemist to inform him as to the quantity of CO given out by Bunsen burners, as the latter were being extensively used at present for lighting in connection with incandescent mantle gas burners. My impression has been that the more perfect the combustion the less luminous the flame, which would indicate that the Bunsen burner consumed gas more completely than an ordinary gas jet; so that if either gave off any CO, I should expect it to be the gas jet rather than the Bunsen burner. A little light on the subject from you will greatly oblige a reader.

Deatur, Ill.

FRANK SHLAUDEMANN.

[Non-luminous flames are the most liable to produce carbon monoxide. The luminous flame, with proper burner, is the safer in this regard. If anything is done to cool a non-luminous flame, such as inserting a heavy wire gauze in it, the gas in question is very apt to be produced along with other products of incomplete combustion. But a proper Bunsen burner gives perfect combustion and is perfectly safe. You will always know if carbon monoxide is being produced, generally by the odor of the accompanying products of incomplete combustion and by the headache which it will soon produce.—ED.]

The Phenomenal Growth of Potatoes.

To the Editor of the SCIENTIFIC AMERICAN:

My letter published in the SCIENTIFIC AMERICAN of January 25 brought me in the first mail 85 letters of inquiry, and they have been arriving continually ever since. It looks as though every farmer in the United States reads your paper. It would be impossible for any one man to answer all these letters, some having written three times, but the main questions can all be answered in a few lines. If you will publish them, I will send a set of questions and answers for the benefit of your readers. There appears to be a great mystery surrounding the sprouting of potatoes in boxes and barrels without earth. C. E. FORD.

Rush, Texas.

[We have arranged below the questions received by Mr. Ford and have appended the answers.]

1. Q. At what temperature do you keep your sprout house? A. Summer heat, or 80° to 90° F. 2. Q. Will a stove answer for heating the sprout house? A. Yes. 3. Q. Do you put earth or anything in the barrel with the potatoes? A. No. 4. Q. Do you put water on the potatoes? Is extra moisture required in the sprout house? A. No. 5. Q. Do you cut the potatoes before putting them into the barrel, or do you put them in whole? A. Put them in whole. 6. Q. In planting, do you separate the young potatoes from the old mother potatoes? A. No; plant all together. 7. Q. Are not many of the small potatoes broken off so that they will not grow? A. About one-tenth of them are broken off. A wooden paddle or trowel is used to separate those that are to be planted. A wooden paddle injures the roots and potatoes less than an iron trowel. 8. Q. What is a "balk"? A. A ridge of land left unplowed between furrows. It is left in a ridge with inclined sides by leaning the plow to the left. The "balk" gives more surface for the expansion and growth of the young potatoes. 9. Q. What is meant by "water furrow"? A. A bead is made by making two or more furrows together. The lowest ground between the beads is a "water furrow." 10. Q. How do you prepare your liquid manure? A. I have a large number of cattle which I keep in a pen every night, and the manure gets very deep, and when it rains the water runs from the pen to the potatoes; and if it does not rain when I want to irrigate my potatoes, I run the water into the cattle pen first and drive the cattle round and round, stirring up the manure, which I then run into the potatoes. 11. Q. What kind of fertilizer do you use and how much? A. I use cotton seed, covering the ground 4 to 6 inches deep for one crop. For the next crop I use green cow manure, covering the ground 6 to 10 inches deep. It is impossible to get the ground too rich. My soil is sandy and about 3 feet in depth before the clay is reached. 12. Q. What kind of seed would you recommend for growing potatoes by your method? A. Any kind that grows best in your locality. 13. Q. Do you irrigate, and how often? A. Yes; continuously. If the potatoes become dry, they will cease to grow. 14. Q. Can I obtain potato seed from you? A. I have no potatoes to sell. 15. Q. Can I use your system in New England and Canada? A. Yes. 16. Q. Do I understand that a crop of potatoes can be grown every 4 or 6 weeks? A. In Texas, yes. The potato grower can answer this question for his own locality by observing how long it takes for a potato to grow from the size of a small marble to a size suitable for eating

or marketing. I grow the potatoes in the sprout house until they attain the size of marbles; then they have all the roots and begin growing immediately when planted. It is probable that in Canada and New England two crops could be grown without trouble. 17. Q. Why do you plant your hills across the rows and not lengthwise? A. To secure an even distribution of the potatoes.

SECURING VEHICLE WHEELS TO AXLES.

A device which can be operated without the use of tools, to attach or remove the wheel, locking the hub so securely to the axle that it cannot be accidentally removed, is shown in the accompanying illustration, one view showing the improvement applied, with a part of the cap broken away, while the small figure is a sectional view. The improvement has been patented by William F. McQuivey, of Seattle, Washington. The hub has an end plate which fits around the end of the axle, a flange of the end plate overlapping the face of the hub, and being provided with a coarse thread to engage a screw cap. Pivoted to the end plate are semicircular locking plates, with semicircular recesses fitting around a screw projected from the end of the axle, there being a washer between the head of this screw and the locking plates. Fitting snugly over the end of the hub and against the locking plates is a screw cap which has at its inner edge a recess engaging a catch movable in and out in the hub, the catch being normally pushed outward by a spring, and having a projecting thumb piece. On pushing the catch inward the screw cap may be unscrewed from the hub. With this improvement the axle may be more easily lubricated than where the ordinary nut is used, and with-

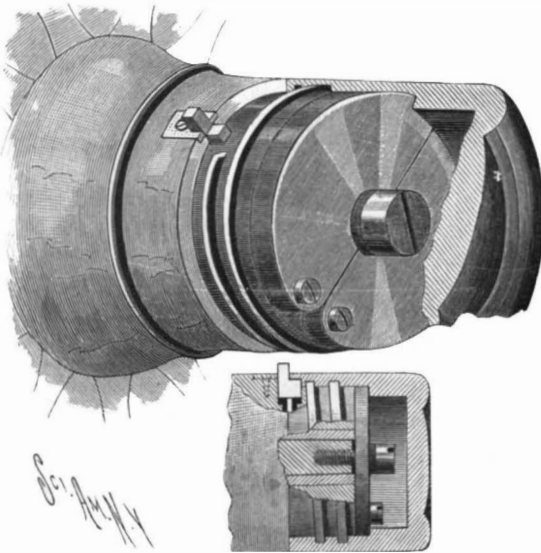

McQUIVEY'S DEVICE FOR SECURING VEHICLE WHEELS TO AXLES.

out soiling the hands or the clothing, and the device adds to the neatness and good appearance of the wheel.

Mannocitin.

The rust-preventing compound "mannocitin" is the invention of Edmund Muller & Mann (chemical works) of Charlottenburg, near Berlin, Germany, and is manufactured exclusively by that firm. The article was put on the market in Germany in January, 1892, and has since been adopted by German state railways, by the leading iron and steel works, by engine and machine builders, tool manufacturers, etc. It is extensively used by all trades making and using machinery, as is evidenced by a large number of trustworthy testimonials. Besides railways, iron, steel, machine, and tool companies, the following are users of mannocitin, viz, steamship companies, shipbuilders, mines and smelting works, gun works, bicycle and sewing machine factories, flour mills, gas and water works, departments of public works, stove works, glass works (for use on iron moulds), breweries, textile factories, paper and pulp mills, beet sugar refineries, watch makers, metal workers, and machinists. These trades are enumerated to show that the article is of interest to all industries manufacturing, dealing in, or using machinery or metal goods of any description.

In Germany, where the manufacturers first introduced their compound, it is largely used, as it is also in England, France (where it was awarded a medal at the Bordeaux Exposition in 1895), Austria, Norway and Sweden, Russia and other European countries. Wherever it has been properly employed, mannocitin has given good results.

This compound is composed of greases and volatile oils. The compound is very thinly applied on the metal, which should be clean and dry. The volatile oils evaporate after application to the metal, and there remains a thin film or skin which tightly adheres to the metal and forms the coating, which affords complete and permanent protection and prevents rust and corrosion.

The advantages claimed for mannocitin are: That it is absolutely neutral, containing no acid, and it does not take up any acid from the air or water; an arti-

cle once coated with mannocitin is protected as long as the mannocitin coating is allowed to remain on; it consequently protects the metal for years. The mannocitin coating forms a protection against salt air, dampness, fresh water, salt water, perspiration and fumes of muriatic acid and ammonia. This compound has the advantage of spreading and thereby covering a very large surface. With one gallon, a surface of over eleven hundred square feet can be protected.

It may be easily applied with a rag and is always ready for use; it does not rub off in handling, and is not absorbed by dust or by paper wrappers (this is of great advantage in the case of small tools). It is quickly removed with turpentine or benzine, and as it is removed simply with a rag saturated in one of these liquids, scratching the metal is avoided, and the original polish of the metal is preserved. It can, therefore, be used on the most delicate metal surfaces, such as engravers' steel plates. As the mannocitin coating is transparent it does not discolor the metal or injure or spoil its appearance. Mannocitin has a very high melting point, and can therefore be used on boilers without melting. It is not of the nature of a paint or lacquer, and it is not a petroleum product.

The article is applicable to the smallest and finest tools, as well as to the largest machinery. It is put up in small cans for the individual user and in larger cans and barrels for a large manufacturer.

Mr. Otto Goetze, of New York City, has charge of the business relating to mannocitin in this country.

Nuts on Wagon Axles.

Every now and then one hears of a wagon wheel coming off through the loss of a nut, and an accident of this sort is apt to be attended with further injury to the vehicle or its load. If the latter is heavy, the end of the axle is liable to strike the ground abruptly enough to break off a portion, or at least to spoil the screw thread. This thread, by the way, is righthanded at one end of the axle and lefthanded at the other, so that the nut in going on turns in the same direction that the wheel does when the wagon is moving forward. If the wheel exerts any influence on the nut through friction, therefore, its tendency usually would be to tighten the nut. It would only be in backing, apparently, that the nut could be loosened from that cause. It is surprising, perhaps, that such a thing should happen at all, but it does, and a good many people, farmers and blacksmiths, have wondered how it could best be prevented.

A generation or two ago some carriage makers put a pin through the nut and the axle top. This of course would serve well enough for a while, but after the nut had been removed several times, in order to allow the axle to be greased, the thread would be worn a trifle. Hence, if the nut were tightened up properly with a wrench, the hole would not be in the right place for the pin. One of the Tribune's subscribers recommends a slight improvement on that plan. He fixes a coil spring in the aperture in the nut into which the pin is inserted, and the spring tends to thrust the pin into place when the nut is on. But the improved plan does not seem to meet the objection just mentioned.

Another scheme, which has been tried with great success on fine carriages for many years, is to have two nuts, one going on after the other, and each screwing in a different direction. A pin ties the two together, and the double nut is thus perfectly locked. The patent on this idea ran out long ago, and there are several makers of this style of axle. But one must pay an extra price for it. This is the most efficient plan in use, probably; but it has been suggested that nuts, not only on axles, but also on the bolts through the ends of the springs, might be kept in place by using spring washers, such as are now employed in certain parts of arolley car gear, and as nut locks for railway track bolts. Again, a wonderful grip is secured in one of the track bolts lately introduced by cutting the thread in a peculiar way. The same scheme ought to work on a wagon axle.

However, there are plenty of country wagons and city trucks, some of which are used in hauling enormous loads over rough highways, which are provided with no special means of securing the nuts, and yet which never lose one. The secret of this, probably, is that the nuts are well fitted, and are closely watched. If the nut pinches tightly enough, and if the screw thread is kept free from grease when the wheel is off, no accident of this sort ought to happen. But when the nut is worn by long service, and goes on too easily, there is always a certain amount of risk, especially if a man is careless in greasing the wheels. And such a man, too, will probably neglect to examine the nuts occasionally and try to tighten them with a wrench. New York Tribune.

Electricity in Dentistry.

Dr. M. G. Jenison, of Minneapolis, reports that electricity has been successfully employed by him in checking hemorrhage from the extraction of teeth. The current, he states, caused instant coagulation of the blood and gave relief where the usual remedies were without effect.

THE BUFFINGTON-CROZIER DISAPPEARING BARBETTE CARRIAGE FOR THE EIGHT INCH B. L. RIFLE.

The views which we herewith present of the standard disappearing gun mount for coast defense batteries will possess especial interest at the present time. Our recent diplomatic deadlock with a firstclass naval power has again raised the question of adequate sea-coast defense; and has riveted the public attention upon it more strongly than ever before. That this nation has a large portion of its wealth located along its 3,000 miles of seaboard is no doubt generally understood, and also that in the event of naval attack by a hostile power it is practically defenseless; but just how vast the total value of this property is, and just how utterly exposed to the possibility of speedy destruction, the great mass of the people at large, and especially those of the inland States, have never fully realized.

Elaborate plans of defense have been drawn up and are only awaiting the sanction of Congress for their execution. At the present writing the bill reported by the Senate Committee on Fortifications proposes an appropriation of \$80,000,000, of which \$10,000,000 should be available during the rest of this fiscal year and the whole of the next one, and \$10,000,000 a year should be available thereafter for seven years. The report further says: "It has been estimated that in the cities of New York, Brooklyn, and Jersey City alone there is property of the value of \$4,000,000,000 which a hostile fleet, lying in the upper bay of New York, would have within reach of its guns. Not one-tenth of the necessary defenses has yet been provided for that port, although its harbor is at present better defended than any other in the United States."

We have a navy which has received the favorable criticism of every foreign power, and it is rapidly approaching the front rank. In building up a system of coast fortifications we shall be providing the necessary counterpart of an effective navy. The committee says that its very existence would be imperiled in case of war with any great power, without the support which would be afforded it by land defenses.

The Buffington-Crozier disappearing carriage, which will be the standard type for coast fortifications, is shown in the loading position, where it is entirely below the parapet of the barbette; also in the elevated position for firing.

The carriage is of the front pintle form, and consists of the following principal parts, viz.: The levers, the top carriage, the cheek plates or chassis, the elevating gear, the racer, the live rollers, the base ring, the transoms, the traverse wheels, the traverse circle, the traversing gear, and the projectile crane.

The trunnions of the gun rest in bearings bushed with bronze, on the upper end of the levers. The levers are made of cast steel, and are pivoted near their middle points upon an axle of forged steel. The axle rests in bearings bushed with bronze in the top carriage, which is formed with the two hydraulic cylinders in one piece of gun iron. In each cylinder are two throttling bars of steel, which pass through notches in the piston and serve to regulate the size of the orifices for the flow of the liquid past the pistons, being of variable cross section. The hydraulic cylinders are connected by a pipe at their forward ends to equalize the pressure in them during recoil.

The piston rods with the pistons formed on them are made of forged steel, and are fastened by means of nuts to projections on the front end of the chassis. They are produced through the rear cylinder heads.

The top carriage rests upon rollers of forged steel, which are placed in recesses in the cheek plates. The axles of the rollers are of forged steel, and the rollers are bushed with bronze where the axles pass through them. The cheek plates are made of cast steel, and are united by three transoms, also of cast steel, the rear one being for the traverse wheels. The cheek plates are bolted at their forward ends to the racer, and have guides bolted to them for the elevating rack. Their upper surfaces have a slope of 2° to the front to facilitate the return of the piece to battery, and to reduce the preponderance of the counterweight.

The elevating rods are of forged steel, the journal bearings, at their upper and lower ends, being bushed with bronze. The lower ends of the rods are attached to elevating racks of bronze. The elevating hand-wheels are of wrought iron and are mounted on a through shaft, upon which are pinions of bronze gearing into spur wheels of cast steel. On the shaft with these are pinions of bronze, gearing into the elevating racks.

The action of the system in recoiling is such that, no matter what elevation the gun may have when fired, it will have practically the same inclination to the horizontal—about 7°—in loading position.

The racer is of cast steel, and the base ring of gun iron. Their inner parts form a pivot or pintle, which has a spiral groove cut in one of its surfaces to facilitate lubrication. The base ring is fastened to the platform with sixteen 1½ inch holding-down bolts. The rollers are conical and of forged steel.

The counterweight is of lead, and weighs 32,000 pounds. It is suspended by two rods from a shaft joining the lower ends of the levers. This shaft is of

forged steel, and passes through the lower ends of the levers into two clips forming a crosshead, and the holes in the levers being bushed with bronze. It is pinned to the clips, with which it forms the crosshead. The crosshead clips are of cast steel and lined on their bearing surfaces with bronze strips. They are given additional support, when in the lowest position, against a projection of the chassis.

The crosshead guides are formed on the inner sides of the chassis. A vertical ratchet is made on one face of each crosshead clip to be caught by a pawl on the chassis and thus to hold up the counterweight. This pawl is mounted upon a short crank actuated by a long lever at the side of the carriage, and the arrangement is used for lowering the piece, should the recoil not be sufficient.

The rear traverse wheels and their transom are of cast steel, and the axes of the wheels rest on roller bearings.

The traversing chain lies around the traverse circle and is fastened to the parapet. It is provided with an arrangement for taking up the slack. The circle is of gun iron, and is cast in segments and fastened to the platform by 1½ inch holding-down bolts.

The action of the carriage is as follows: Upon firing the piece the central pivot of the levers moves horizontally to the rear, carrying the top carriage with it. The lower end moves vertically upward, being constrained by the crosshead guides. The gun moves downward and to the rear in the arc of an ellipse. The energy of recoil is absorbed partly by raising the counterweight and partly by the resistance of the hydraulic cylinders. After loading, the pawls are tripped and the greater moment of the counterweight enables it to raise the piece into battery. The return to battery is softened by hydraulic counter-recoil buffers in the cylinders, forming a sort of dashpot.

The piece is hauled down in the loading position by hand for drill and cleaning by a windlass arrangement, the rope leading through sheaves on the levers and chassis.

Three fulcrum pins are inserted in each chassis near the forward end of the top carriage to serve as points of support for pinching levers held vertically, and engaging in ratchets bolted to the under sides of the top carriage clips, for heaving the top carriage forward in case it should not return to the firing position. A spring prevents the loading crane from swinging to a position under the breech of the gun, where it might be struck by the latter upon recoil.

This carriage is capable of great rapidity of fire. Ten shots from an 8 inch gun have been fired from it in twelve minutes and twenty-one seconds. In the loading position the gun is completely covered from a shot arriving at an angle of 7 degrees. The field of fire is 127 degrees, and the pointing of the gun can be varied from 12 degrees elevation to 5 degrees depression.

The project for the defense of New York harbor contemplates for the present, among other guns, fifteen 10 inch and nine 8 inch guns on disappearing carriages. Probably ten 12 inch guns on the same carriages will be added to these.

The exact distribution of these guns at the various strategic points in the harbor, for obvious reasons, is not disclosed to the public. An attacking fleet would be practically at the mercy of such a battery of disappearing guns. At the outset it would be ignorant of the location of the fort; and the use of smokeless powder would render the detection of the guns, during the few seconds that they showed above the parapet, a difficult matter. The only possible chance to place a shell inside the fort would be by making use of high angle fire; and this is impracticable in the modern war ship as at present constructed, for two reasons: first, that the existing gun carriages will not allow the breech to be sufficiently depressed to admit of such fire; and, secondly, that the existing decks are not strong enough to withstand the heavy vertical strain of the recoil. The aiming of the gun is all done under shelter. By means of a "range finder" and the "converter board" the gunner can lay the piece with perfect accuracy while it is yet below the level of the parapet. Gun for gun, such a battery has an enormous advantage over the floating fortress, for it would have in its favor: 1. Invisibility. 2. Absolute protection from gun fire. 3. Absolutely steady platform. 4. Absolute determination of the range and bearing of the enemy. To this must be added the moral effect upon the courage and endurance of the gun crews, resulting from their superior protection.

Electrical Progress in China.

The China Gazette, speaking of the growth of electric lighting in Shanghai, says: "A couple of years ago there were only about seven miles of streets lighted by electricity, for which 60 arc lamps were quite sufficient, and there was not a single incandescent lamp in or around Shanghai. Now the electrical department of the Municipal Council runs 140 arc lamps, lighting some 15 miles of streets, and there are about 43 miles of line wire laid, in addition to 6,100 incandescent lamps

of 8 candle power each, for domestic purposes. The customers for incandescent lighting have increased from 1 to 55 in number since the Council took charge of the department."

Rubber Shoes Sixty Years Ago.*

To make a satisfactory purchase of a pair of rubber shoes, sixty or more years ago, was an undertaking requiring the accredited keenness of a "Philadelphia lawyer."

Boston, Mass., was then headquarters of the rubber trade, the largest importers being found there, where, besides supplying the regular trade, the commission merchants held rubber auctions at stated seasons.

Notices sent abroad secured a full attendance of boot and shoe dealers from New York, Philadelphia, Baltimore and all around, for "runners" were not thought of in those days of slow coaches.

Most of the rubber, and the best, came then, as now, from Para, South America, or along the Amazon River where natives procured it by tapping the trees. Clay and wooden lasts of various sizes were dipped in the cream-like liquid, the coating being dried by a dense smoke exactly as is done to-day.

When the several dippings were over, the shoes were stamped on the toes in fancy designs, more or less elaborate, taken off the lasts and stuffed full of rice hulls and hay; the tops were then sewed together with twine, or coarse thread.

Two of about the same size were tied together, and these ill-assorted pairs were packed in wooden boxes of all sizes and shapes, mostly sugar boxes, and shipped to foreign ports.

A boot and shoe dealer receiving a box would immediately consign it to the cellar of his store, where, on being opened, the stitches would be cut, the hulls and grass emptied out, together with a few scorpions and other live stock such as frequently took passage in the shoes.

The shoes were then turned wrong side out and after a thorough washing inside and out to free them of all adhering clay and dirt, were left to dry.

Then followed the tedious process of trimming and shaping them. Each shoe was turned over a wooden last—the one that seemed to be about the right size. If it was not sufficiently large, another would take its place. If too large, the shoe was heated and by extra exertion was often made to work down to the required capacity. Then with sharp scissors the edge was neatly trimmed and after being sponged with Japan blacking, the shoe was ready for sale. Only about enough for one or two days' sales were made ready at one time, the boys working evenings preparing them.

A customer desiring to purchase a pair of No. 4's was shown a pair that were stretched over that size of last. They may have had originally, the one a round toe, the other a pointed toe; one may have had a thin, the other a thick top—but so long as they could be made to cover a certain last that fixed the size. If one of them shrunk on being removed from the last, it was heated and put on again, and possibly heated a trifle before trying it over a customer's boot. It was a common occurrence to have a customer return with a shoe, or a pair of them, that drew the feet so badly they proved worthless to him or her. If the shoes had been worn, they were generally taken back in exchange for a less expensive pair, and on being heated some, the indentations were easily worked out, so the pair was just as good as new.

Repairing and resoling rubbers was a very nice operation, requiring great skill and cleverness. The shoe was again put on a last, when the sole or part to be mended was shaved with a sharp knife until it was all fresh and adhesive, and then a similarly prepared piece of rubber was put over it, the fresh surfaces pounded together and then trimmed neatly around. The shoes being soft and easily injured, had to be frequently mended.

They tore readily; stones and sticks penetrated the soles, heat softened them, cold stiffened them, and the sun discolored them; but notwithstanding all that, every woman and child, and many a man, was obliged to wear them through the muddy, sloshy, and snowy seasons: so the sales were proportionally great.

Rubber overshoes sold at wholesale from 25 cents a pair upward, retailing from 50 cents to \$1.25 a pair, according to their evenness of texture, their shapeliness and the elaborateness of their stamping; for the latter was a point of beauty not to be overlooked.

The dealer himself could not be sure of his goods and the purchaser could only be guided by the dealer, as he or she knew nothing of the extra stretchings, or the mysteries of the trade, usually carried on below stairs by the apprentices, or boys, who were early taught to stretch their consciences with their goods.

Here and there may occasionally be found a man whose hand even now bears the marks of trimmings done on "gums" during the days of his youth, but there are comparatively few people living who remember the old time rubber shoes, with their stamped toes—which were considered a valuable improvement over wool socks and Indian moccasins.

* By C. A. Lynde, in the Christmas Boot and Shoe Recorder.

Slides Without Mat Covers or Binding.

Rev. W. M. H. Young, Ph.D., says: Of course, no one objects to elegantly mounted slides; but there are hundreds of clerical and other lanternists, like myself, who cannot afford all they would like. Those of us who exhibit weekly to the same people year by year have to prepare numberless new slides, many of which are to be used but once only. To mount them in regulation style, with cover glass, mat, binding strips and printed titles, would be a waste of time and money under the circumstances. Any yet we do not wish our views to present a slovenly appearance on the screen.

I prepare my negatives so that the result upon the screen is the same as the best mounted slide. The process consists in cutting off the film of the negative with a very keen chisel, leaving that portion of the picture that would usually be shown through a mat.

Draw upon the film of the negative with a pencil the exact size and shape you wish the "mat opening" to be. Of course, some sort of a guide must be used for the corner of the chisel, and keep at it until the film is cut entirely away outside that part of the view to be copied upon the transparency. The clear glass thus exposed will make a dense border around the picture upon the transparency, which will take the place of any mat. This method works equally well for contact or camera transparencies.

If irregular designs are desired instead of the ordinary rectangular mat openings, it is easy to make them—and highly artistic too—by holding the chisel at an angle while cutting the outline. In this way the film is pared off beveled, giving a peculiar gradation of tone to a scalloped design.—The Optical Magic Lantern Journal.

THE ECCENTRICITIES OF A RAILROAD COLLISION.

We have been favored by Messrs. Clayton A. Smith and Dell Vaughn, of Waverly, New York, with a photograph of what the local railroad fraternity describe as one of the most curious wrecks in the history of railroading. It occurred in the Towanda station yard of the Barclay Railroad, where three cars, which had been left standing on the main track, were run into by a regular train under full steam. The car next to the engine, which is usually in such a case smashed into the proverbial kindling wood, was lifted up and forced over onto the top of the locomotive. With the exception of the injury done to the smoke box and stack, and to the roof of the cab, the locomotive was not damaged. It remained on the track, and was able to carry its strange burden into the village of Waverly, where the photograph was taken. Mr. Smith writes that the local railroad men say that the cause of the car taking this position was that the swing bumpers on the engine, which were down at the time of the collision, were thrown upward, and lifted the front end of the car.

We think it is probable that the drawbar and timbers, which can be seen embedded in the front end of the smoke box, contributed to the result by pivoting against the boiler tube plate, and lifting the car still further, as they were torn from their fastenings.

That this Erie box car should have kept its shape so

well under such rough handling speaks volumes for the excellence of the material and workmanship.

PRINTS OF SCARS.

BY FRANCIS GALTON, IN NATURE.

The accompanying print is sent with a twofold object. First, for its intrinsic interest in showing how thoroughly and definitely a grafted slice of skin and flesh has established itself under its new conditions, retaining its original characteristics unchanged during thirty years. Secondly, because of its probable interest to surgeons in illustrating the ease and complete-



ENLARGED PRINT OF A MISPLACED GRAFT OF FLESH ON A THUMB, THIRTY YEARS AFTER IT WAS MADE.

ness with which a record can be kept of the process and results of the cicatrization of wounds.

Prints are more clear, more cheap, and more trustworthy than photographs. They are not distorted through perspective, nor blurred owing to differences of focus; they can be taken in any light, and their scale is absolutely correct. They are made by rolling the scarred part on a porcelain pallet or metal slab, that has been covered evenly and very thinly with printer's ink; or, conversely, the pallet and paper are rolled upon the scar. As many duplicate prints can be taken as desired. I have written at so much length about these and alternative methods of printing in my book, "Finger Prints," and elsewhere, that I need say no more about them now. The print sent herewith is a photographic enlargement, being more suitable for rough process printing than the somewhat minute originals; but one of these is also included. The history of the graft is as follows: J. R. H., who is a solicitor in large practice, when he was twenty-five years old, sliced a piece clean off the thumb of his left hand. He was cutting cardboard with a sharp knife guided by a rule, upon which the thumb pressed and which it slightly overlapped. The piece that was cut off fell on the table; it was at once picked up, clapped upon the wound, and the thumb was tightly bandaged. After a few days reunion had taken place, and the wound was healed. It then proved that the

graft had not been replaced in its original position, but crossways to it, as seen by the papillary ridges in the accompanying print, taken in 1895, thirty years after the accident.

Art Pottery.

Mr. Holman Hunt, in the course of a paper on the future of the "Della Robbia" and artistically decorative pottery work, given at a recent reception at the Della Robbia Pottery Works, Birkenhead, England, called attention to certain experience which the history of ornamental design had established as an irrevocable and eternal fact. He went on to say: Art schools are producing artists who are not artists by nature, and who can never do anything but create confusion as painters of pictures or sculptors of human and animal form. It is important to dwell upon this truth in considering the needs of the pottery work whose fate we have to decide at this juncture. It was founded to redirect art energy toward industrial forms of daily need and use. I cannot pretend to express opinions about the very important financial questions, and these are most important in my eyes, because I don't like charitable feelings toward art. It must be recognized to be worth the money it costs. Art must be self-supporting. I will, however, express my opinion that the aim of this enterprise from the beginning was to bring back vitality to domestic art. We cannot review the past without recognizing that no art grows in a day. We in modern England are too impatient. We sustain a class of active writers ever on the watch to find or to imagine flaws in sincere attempts of the true artist, whatever his department may be. My comment upon this tendency is to say that I could find numberless faults in the Madonna de San Sisto, in Raffaele's Cartoons, in Michael Angelo's Sistine Chapel, in Tintoretto's Crucifixion, while in a Murillo picture of the Holy Family in our National Gallery I could find no fault. There are many other great attempts equally without flaw, but the first set named are the godlike works of the heroes of art, the second set are the products of the measured rule and the paint pot. Well, perhaps the work done by the pottery works may be open to criticism. For the time of its attempt to get its feet, some crudity and awkwardness in its struggles should be a welcome sign of life. It does artistically show signs of vigor and health. It must be business men alone who can start it in life. Palissy ware was in the same straits in its early days. You all know the story of the inventor begging his wife's wedding ring to put into the crucible. If help can be gained and this industry can be saved and perfected, it will be an aid not to itself alone, it will shame painting and sculpture out of mere mockery of antiquated art and out of the mummy-like representation, more or less disastrous or impudent, of the outside skin of the discolored corpse of nature.

ALUMINUM has not proved to be of very much value for surgical instruments, as it is deficient in elasticity and will stay bent. The instruments are also so light that the surgeon actually feels the want of the accustomed weight of his regular instruments of steel.

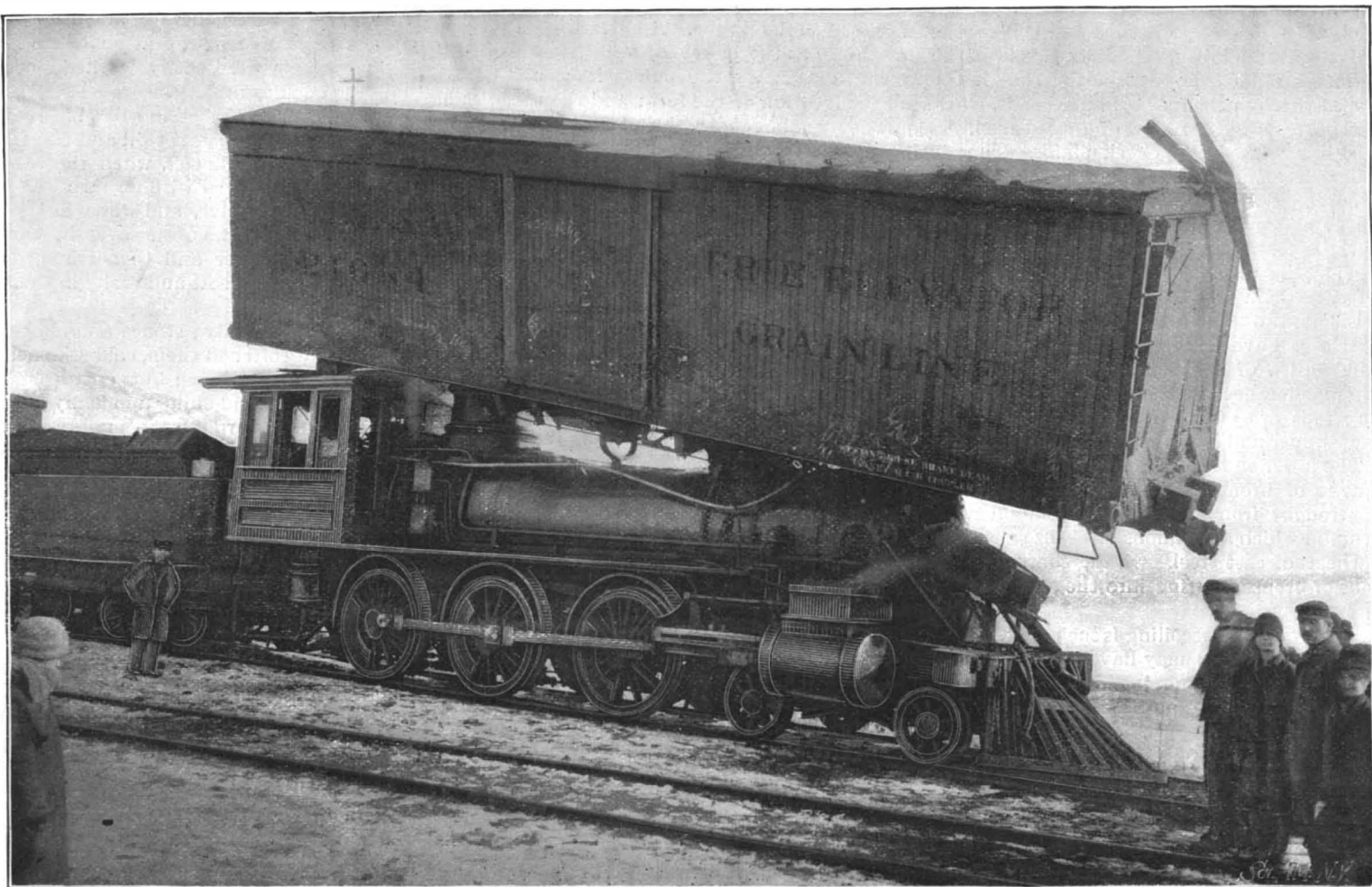

CURIOUS RAILROAD WRECK AT TOWANDA PA.

INACCESSIBLE MARITIME LIGHTS.

BY ELMER LAURENCE CORTHELL, C.E., D.S.C.

The most unique system of electric lights to guide navigation is that in use at the entrance to New York Harbor. In order that the importance of the system

of navigating these channels on a very dark night without some adequate system of lights in the channelway. The direct range light on shore is 13 miles distant. It was generally necessary for steamers to lie to outside for daylight before entering the harbor.

cable of large size in two nearly parallel lengths from Sandy Hook point to the channel; the new method, one small cable only. The size of the direct current cables was $1\frac{5}{8}$ inches, that of the new single cable $\frac{7}{8}$ of an inch. The original system provided six lights,

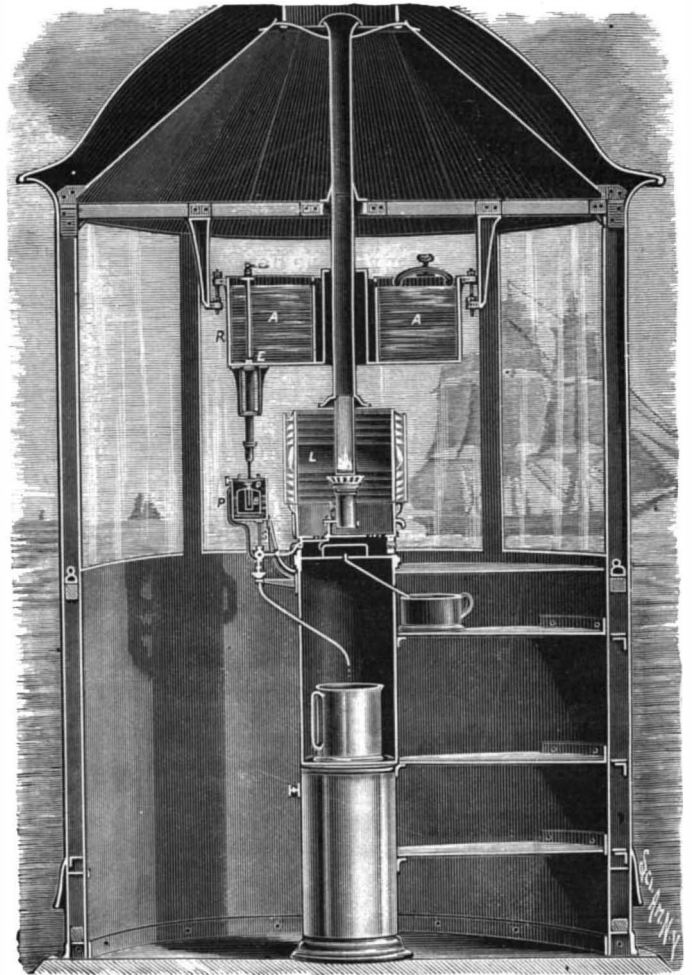
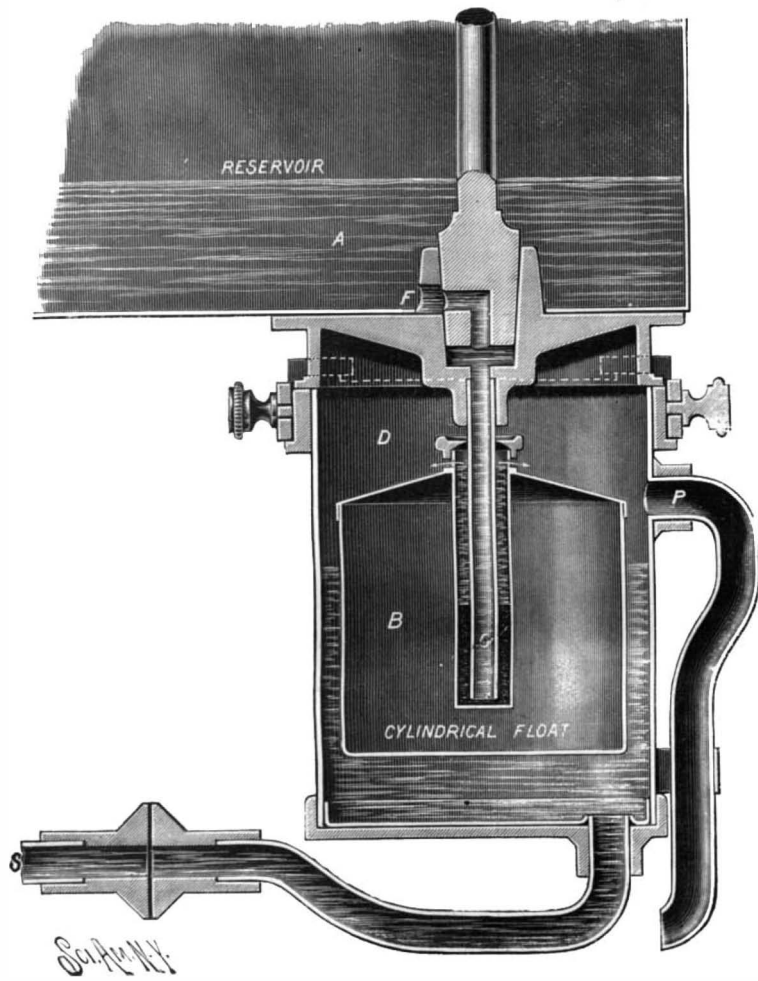

Fig. 3.—OIL RESERVOIR AND REGULATOR—FISH OIL LANTERN.

and its necessity may be appreciated, a general map of New York Harbor (Fig. 1) is given and referred to for more detailed information.

New York Harbor has two communications with the ocean, one by way of Long Island through the East River and Hell Gate and the other through the Narrows, between Staten Island and Long Island. The latter is the only one now practicable for sea-going vessels of the larger class, and therefore is of vast importance to the commerce of the metropolis. There are two principal channels at the Narrows, as shown on Fig. 1; in fact, there are several channels across the entrance bar, used according to their depth. Nearly all of the coast steamers and sea-going vessels of

The entrance was therefore practically closed at night to deep draught vessels. It was particularly necessary to light Gedney's Channel, the main channel being quite plainly marked by a sufficient number of range lights on the shore, and then, too, the channel is wider. It became still more important to light Gedney's Channel from the fact that the government had expended large sums of money in dredging it to secure a depth of 30 feet through it at mean low water, with a width of 1,000 feet. It became therefore proper to secure the largest possible results to navigation. The great distance of the channel from the shore made it necessary to adopt some system of floating lights. After studying several methods, a direct current sys-

tem of electrically lighted spar buoys was determined upon and installed in 1888, the first exhibition of the lights being on the night of November 7.

In this original system the direct current method was used, and in the improved system alternating currents; the original system required a three-conductor cable of large size in two nearly parallel lengths from Sandy Hook point to the channel; the new method, one small cable only. The size of the direct current cables was $1\frac{5}{8}$ inches, that of the new single cable $\frac{7}{8}$ of an inch. The original system provided six lights; by the former the channel was lighted 4,000 linear feet, by the new system 8,000 linear feet. As early as 1890 the great electrical and other advantages of the alternating current system of operating incandescent lights on long circuits led to experiments of testing it for lighted buoy systems. These experiments showed that the proposed method would be more economical and altogether more satisfactory. The experience gained at Chicago with a cable laid in the water from the Exposition to the city, about 7 miles, and further study and experiment, led to the very satisfactory method only recently installed at Sandy Hook and above mentioned. Figs. 1 and 2 will

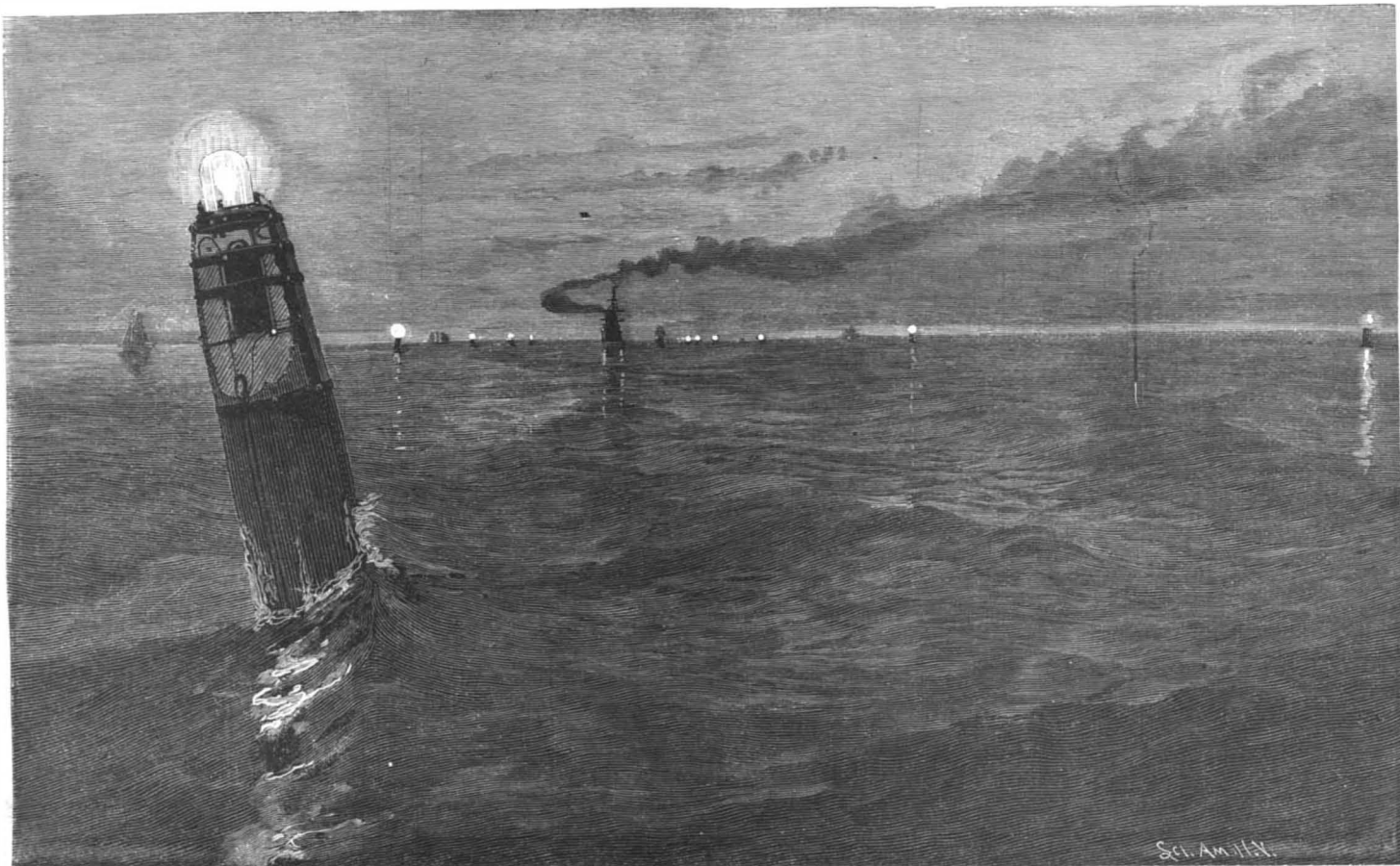

Fig. 2.—ELECTRIC LIGHT BUOYS IN NEW YORK HARBOR.

moderate draught use the South and Swash channels, as these are by far more direct than by the extremely tortuous Gedney's and main channels, which constitute the only entrance to New York Harbor by the great ocean liners and deep draught ocean freighters. An inspection of Fig. 1 will show the impracticability

tem of electrically lighted spar buoys was determined upon and installed in 1888, the first exhibition of the lights being on the night of November 7.

In this original system the direct current method was used, and in the improved system alternating currents; the original system required a three-conductor

show clearly the new system. The spar buoys are juniper wood 50 feet long, held in place by mushroom anchors weighing 4,000 pounds. The lamps, which are attached to the top of the buoys, are 100 candle power of improved design, with 5 inch globes. The length of the cable used is about $6\frac{1}{4}$ statute miles, with

the additional length of nearly 2 miles to the south-west spit buoy.

We come now to perhaps the most fully developed method, that by common mineral oil. In Sweden and England, but particularly in France, has this method been highly perfected. Some very ingenious methods have been devised to overcome what will at once be seen to be serious obstacles, particularly the uneven burning of a wick and its early wasting away by being constantly lighted. It is well known that the chemical action upon a wick causes the light after a while to go out, but if the same charred wick be raised again it will continue to burn. In order, therefore, to obtain permanency to the lights, it is necessary to use a wick already charred and to regulate its height in some way so as to have a uniformly steady flame for perhaps several weeks without attention. It was found necessary to deposit upon the wick a layer of tar by a peculiar method of incrusting the wick. The supply of oil is in a reservoir, the capacity of which is sufficient to keep the light burning during the entire time it may possibly be inaccessible. The decrease of pressure by the lowering of the oil in the reservoir is provided for by a very ingenious contrivance. It consists simply of interposing between the reservoir and the burner a supply regulator that serves to maintain a constant pressure of oil at the lamp. A section of this apparatus is shown on Fig. 3, in which S is the supply pipe to the lamp, A the reservoir, which may perhaps hold 100 quarts of oil, B a cylindrical float, D a cylindrical box in which B rises and falls, E is a gage and P a waste pipe. Without further description, it will be seen that the supply of oil to the box, D, is maintained at a fixed point, and the supply is renewed from the reservoir as the oil is consumed at the lamp, for the opening at F is regulated by the float and the latter by the supply in the box, B, and this is drawn upon by the supply tube, S, as the lamp burns. The supply, therefore, is made automatically, constantly and economically. The contrivance works with great sensitiveness and with entire satisfaction. The method is used at several points in France.

In order to give a more detailed idea of the method, a vertical section and horizontal plan of the light used at Morées is given, see Fig. 4. Some details should be stated. The lantern, with a diameter of $5\frac{1}{4}$ feet, supports the oil reservoir, R; the lamp, L, rests on a central column and supports the supply tube. A little railway is provided on which the lamp can be moved to one side for cleaning, etc. Provision is made for thorough ventilation by admitting air below, which passes up through the entire apparatus and out at the top, so regulated that it prevents the formations of mists and frosts or any other conditions that would obstruct the light or in any way affect it. The cost of the installation, with the necessary duplicate parts, is about \$15,000. The apparatus established at Cette is similar to this.

Official information has been received through some recent correspondence in reference to the development of this system of mineral oil by applying an ingenious mechanism to make the lights revolve and flash.

The French lighthouse service has succeeded, by means of electricity generated from batteries, in maintaining a rotary motion of a revolving apparatus for at least two months without the care of a keeper. It applied a method which had previously been used in "lightening lights" to obtain permanent occulting lights in which the occultations are produced by a system of screens supported on a revolving mercury float, but the rotation had been performed by a clockwork movement. It was necessary to adopt some other rotating power. In the new method of rotation without clockwork the shaft itself which guides the float forms the axis of the armature of the electric motor. This armature consists of a Gramme ring containing 64 bobbins. The current from one cell enters the armature by means of two brushes which have an arrangement for adjusting the pressure. The inductor consists of two permanent magnets separated from the armature by a slight air gap. The current comes from two battery cells called "Bloc," filled with a solidified liquid, set up in series, and having a capacity of 550 ampere hours. Under these conditions a rotary velocity of about one revolution in ten seconds is obtained; this produces a proper rhythm, while a constant velocity is secured by means of a very sensitive regulator. The experiment shows that the apparatus may continue to revolve for five months without the intervention of a keeper. In practice, however, it would be well to change the batteries every two or three months. This would cost only about \$50 annually.

A fuller treatment of this most interesting subject, in an important paper from the pen of the same author, will appear in an early issue of the SCIENTIFIC AMERICAN SUPPLEMENT. The above is an abstract of the more immediately interesting parts of the paper in question.

TWO-THIRDS of all the letters which pass through the post offices of the world are written by and sent to people who speak English.

Science Notes.

Hitherto no substance has been known which would absorb nitrogen gas at the ordinary temperature. M. Guntz has been the first to discover such a substance in lithium prepared by his own process, which rapidly and with incandescence absorbs nitrogen at a temperature below dark red. This observation has been confirmed by H. Deslandres, who has repeated the experiment for the purpose of preparing argon from atmospheric nitrogen, as well as from gas from the spring of Maizières (Cote-d'Or).—*Revue Industrielle*.

A biography of Prof. Huxley is now being prepared by his son Mr. Leonard Huxley. All who are in possession of letters or other documents of interest to the biographer are requested to send them to him at Charterhouse, Godalming, Surrey, England. They will be returned after being copied.

M. Moissan has been elected president of the Chemical Society of Paris.

The British warship Penguin, while engaged in making deep sea soundings between Tonga and New Zealand, got bottom at 5,155 fathoms. This surpasses the American warship Tuscarora's record off the north-east coast of Japan, when bottom was reached at 4,655 fathoms.

The Heat in Australia.—Mail advices bring details of the unprecedented period of intense heat which afflicted Australia during the first two weeks of this year. The warm wave seems to have extended over all of Australia. For two weeks the temperature was nowhere below 90° F. and in some localities it reached 122° in the shade. There were many cases of sunstroke, horses dropped in the streets and, with cattle and sheep, died by hundreds in the fields. Springs, creeks and wells dried up and the damage to crops was very great. Many bush fires occurred as the result of the great heat. An unusual feature of the heat wave

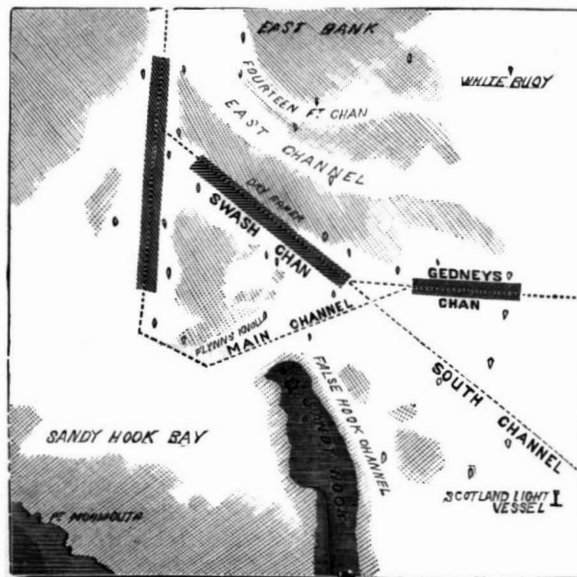

Fig. 1.—CHANNELS OF NEW YORK BAY.

was that a high wind blew most of the time; in some places the velocity of the wind was fifty miles an hour. It brought suffering instead of relief, as it was like the blast of a furnace and blew blinding clouds of dust as well. The heat was felt for a long distance out at sea.

It is said that the Swiss calcium carbide made at Neuhausen yields a large quantity of acetylene gas, from 4.01 to 4.81 cubic feet being produced from a pound of the carbide.

The Royal Academy of Medicine, of Belgium, offers prizes of 25,000, 8,000 and 5,000 francs for the most valuable researches on diseases of the central nervous system, with special reference to epilepsy. The competition closes September 15, 1899.

M. Flammarton, in the course of experiments on the radiation of spectrum colors, has made some interesting observations on sensitive plants. Four plants, sown the same day and of the same size, were placed under glass, excluding respectively all but the red, green, and blue rays, the fourth plant being under ordinary white glass. At the end of six weeks the red plant was twice as high as any of the others, the green came next, then the white, while the blue had not grown the fraction of a centimeter. The red plant was healthy, but abnormally nervous, curling up at a breath. The plant kept under white glass, exposed to the ordinary sun rays, though third in the order of growth, was vigorous and stout.

A German "viking" ship, said to be about 1,000 years old, has been discovered near the East Prussian frontier. It is 40 feet long, and the remains are fairly well preserved.

Corrosion of Aluminum.—Herr Donath, according to the Gas World, says that aluminum is not at all attacked by boiling distilled water free from air, but that it is distinctly attacked by ordinary boiling water. Gypsum in the water renders it harmless, but chlorides, and especially nitrates, make it attack the aluminum. Fat or carbolic acid have no effect by themselves; but with ordinary water, boiling seems to make these attack the aluminum. How about our

new aluminum kettles if this be the case? Herr Zmerzliker confirms these results, and says that hydrogen is given off.

That botanical gardens are popular in England is shown by the following figures: The visitors to Kew Gardens in 1895 numbered 1,407,369; the total for 1894 was 1,377,588, the average for 1885-94 was 1,416,887; the total number on Sundays was 536,181, and on week days 871,188; the maximum number of visitors on any one day was 13,588, on June 3, and the smallest 104, on November 28.

Dr. Kitasato, of Japan, is reported to have discovered a remedy for leprosy by inoculation.

It is found that a 50 year old camphor tree yields about $173\frac{1}{2}$ pounds of camphor, and that a still, charged with about 200 pounds of camphor wood chips, yields from $4\frac{1}{2}$ to 7 pounds of camphor as a fair day's work. The chips are boiled in water over an open fire, and the resulting steam, upon cooling, yields both essential oil of camphor and camphor. In Formosa, most of the oil is thrown away; in Japan, it is employed in lacquer making and for other purposes.

The metric system came into force in Turkey on March 1. The local authorities have received instructions to call together the various trade corporations in order that they should provide themselves with the new weights and measures. The metric system becomes compulsory this year in Mexico and Costa Rica. It is recommended in the British Parliament that it be rendered compulsory in England in two years. In the United States serious consideration is being given by the House Committee on Coinage to the bill introduced by Mr. Hurley to make the metric system mandatory in all official transactions after July 1, 1897, and in all private transactions after July 1, 1899.

La Nature contains a short note in which the horse power of a cannon is calculated. An Italian cannon of 100 tons, with a charge of 550 pounds of powder and a shot weighing about 2,000 pounds, will give an initial velocity of 523 meters per second; the length of time during which the power acts is less than one hundredth of a second, from which it follows that the horse power developed is about 17,000,000. The writer adds that after about 100 shots the cannon is put out of service, and its total active life is therefore only one second. In large modern cannon the horse power runs as high as 24,000,000. If the writer had carried out these calculations still farther, he would have found that, after all, this 24,000,000 horse power does not represent a large amount of energy, as it would be just sufficient to run 31 incandescent lamps for only one day.

The Russian government is to send an expedition to the Amoor to observe the eclipse of the sun on August 9. It will be under the charge of three astronomers from the Pulkowa Observatory. An American expedition will go to Japan to observe the same eclipse.

The Italian statesman, Chevalier Cristoforo Negri, who was born in Milan in 1809, has just died. He founded the Italian Geographical Society, and spent much time in promoting expeditions to Central Africa and to the polar regions.

Pictures Under Artificial Light.—Interesting experiments are now being conducted in the South Kensington Museum, London, relative to showing pictures under artificial light. Capt. Abney has closed a skylight with alternate layers of green, blue and yellow glass. All of the most important actinic rays of light are thus excluded. Artists say that the pictures exhibited under this light are seen in their true colors. The rays which cause paintings to fade are excluded, and the effect of white light is obtained. The experiment is being tried in the Raphael Cartoon Gallery. The general public do not appear to notice any difference between the lighting of this and that of the other galleries.

Oil of cassia has a higher refractive index than cedar oil, and Dr. H. G. Piffard, of New York, finds it brings objects examined in it into sharper contrast. In a paper read before the New York Academy of Medicine, he stated he had worked with a sample having a refractive index of 1.593. Bacilli, examined in this oil, exhibited an unrivaled brilliance and sharpness of contour. The minuter details also, such as spores, flagellæ, etc., are shown with a distinctness impossible in cedar oil. The oil of cassia, like the oil of cloves, tends to abstract the color from bacilli stained with some of the aniline dyes, a disadvantage not shared by cedar oil, but it is stated that this does not take place with sufficient rapidity to interfere with the diagnostic examination.

CELERY OIL.—This is a new industry which Germany is endeavoring to foster. Distillers of essential oils have experimented with the distilling of celery during the past season, producing a few pounds. It is distilled from the green leaves, possesses the powerful aromatic odor and taste of the plant, and may arouse considerable interest among manufacturers of concentrated soups and preserved meats and vegetables. It requires 100 pounds green leaves to make one pound of oil. If it proves feasible to distill celery for flavoring purposes, why not utilize other herbs in the same manner for like purposes?

RECENT EXPERIMENTS IN SCIENTIFIC KITE FLYING.

Some Experiences with Hargrave Kites.—After spending three summers in making, breaking, mending and rebuilding Malay kites, always with an increasing enjoyment and accumulation of information, I found myself forced to the conclusion that Malays are not serviceable enough in winds from 15 miles an hour up. It was with considerable reluctance that I abandoned the Malay for use in high winds, and in the face of predictions that I would regret it, from kite fliers whose knowledge, based on experience, I respect; but after having made and tested Hargraves of very large and quite small dimensions, I reassert my belief in them with absolute confidence. I tested, on one occasion, a Malay weighing nearly 1 pound, having an area of 8 square feet, against a Hargrave weighing 1½ pounds, having a total area of a little less than 10 square feet, in a wind of 20 to 25 miles.

The Malay, at an angle of 45 to 50 degrees, pulled from 4 to 9 pounds; the Hargrave, at the same angle, pulled from 6 to 17 pounds. The lift is easily calculated. The Hargrave was perfectly steady all the time and required no attention; whereas, the Malay, although in perfect condition, needed more or less looking after nearly all the time.

This test was followed up by others almost daily, until from a mass of results there was no escape from the conclusion that the Hargrave was the steadier, the less likely to break or lose its shape in the air, and—what is more important—lifted much more per square foot of lifting surface. What is needed is a kite that can be anchored in the wind and left there without fear of disaster from considerable increase in velocity, and that will fly steadily and will not demand constant mending or balancing.

The thoroughly interested kite flier will supply himself with two or three Malays (say 4 or 5 feet tall) for light winds, and the same number of small Hargraves for heavier winds. In flying tandem they may be used together, and it will be found that the Malays are of great assistance in supporting the Hargraves in case the wind suddenly decreases below that velocity which the Hargraves require; whereas, if the wind increases beyond the point of efficiency for the Malays, they simply circle about or sag (as long as they hold together), and the Hargraves pay very little, if any, attention to them. In my opinion, therefore, a combination tandem team is the best one for most purposes, and especially whenever the wind is uncertain or likely to decrease. With the certainty of a heavy wind, a team of small Hargraves will give one or two active men their hands full.

All mine were built on the proportions given by Mr. Hargrave in his published accounts, and varied in size from 8 feet spread and depth down to 30 inches. The largest turned out to be practically useless, unless I had one or two men to assist, on account of its enormous strength. It was very difficult to find the exact point of attachment, because it could not be readily and safely controlled during experiments. The same proved true of all the others, down to what may be called the "three foot limit." Here I found the most convenient and most useful size, the dimensions of which are given.—J. B. Millet.

It will be found wise in three foot cellular kites, or less, to depend entirely on lashings with waxed shoe thread, and not to make any nail or screw holes. After the frame is put together, before sewing in the cover, paint all the lashings with liquid glue, saturating them thoroughly. This adds very much to their strength and stiffness. My smallest kite is made in this way, and although it weighed but 1½ pounds and exposed to the wind four planes (two in each cell) 30 × 11 inches, it safely outweathered many severe blows (the highest exceeding 35 miles an hour) and is still in good order. The only break was one of the side sticks, which was repaired in a very few minutes. The cover has stretched some, but without affecting the flying qualities to any great extent.

This kite, in a wind of 18 miles up to 35, would easily carry a thermograph weighing three pounds. The best altitude for a period of thirty minutes maintained by this kite was 1,600 feet, with a wind of 18 miles. There was exactly 2,600 feet of large cord out (breaking at 100 pounds—far heavier and stronger than was needed, but no other was convenient), and the angle was greater than 45 degrees for half an hour.

The best material for sticks is small stiff bamboo, while the cover can be made of very thin cotton cloth or percaline. After the cloth is on, and the kite

has been found by trial to fly all right, the cloth should be thoroughly saturated with starch made up with benzine, so that it will dry quickly. Do not use pressure, as you will be likely to stretch the covering. If put on with a wide brush it will cover evenly enough. It should be dried in the shade. When dry, the cloth will be very stiff, and the bending back of

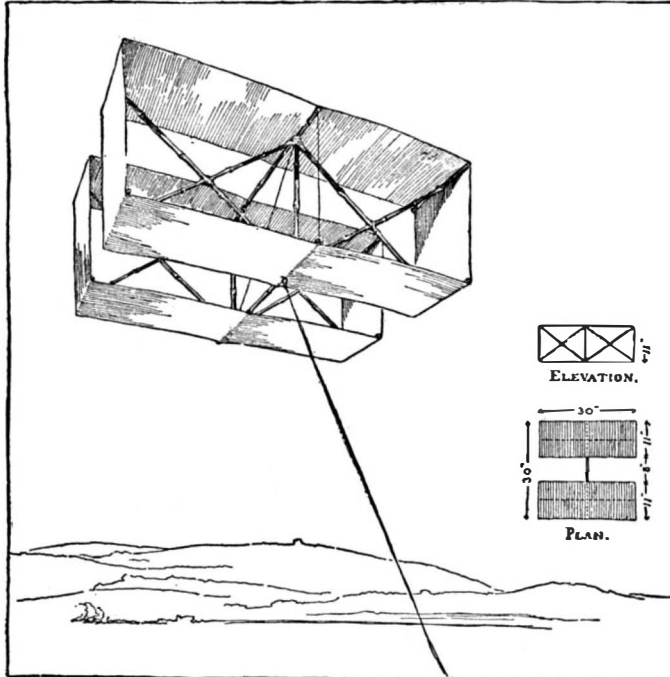

THE HARGRAVE KITE.

the front edges (especially of the fins) will be very largely prevented; while the supporting planes will be much less likely to form pockets and thus increase the drift.—J. B. Millet.

Work on the Great Diamond.—Having an interest of long standing in aerial navigation and also incidentally in kites, and seeing a description of Mr. Hargrave's latest box or cellular kites, I determined to make one. This kite, with some modifications of my own invention, has been about the most successful of any I have flown this year. The dimensions of my kite were as follows: Length of each cell, fore and aft, 25 inches, which was the full width of the black cambric cloth used for a covering. A narrow hem strengthened the selvedge edge. Breadth of each cell,

posed to the wind. Size of section ¾ by ¾ inch. This kite, having so much surface exposed to the wind, 50 square feet, was a very hard puller and uncomfortable to handle in a strong breeze. The writer therefore gave his attention to devising some arrangement whereby undue wind pressure might be relieved and the kite flown with less danger of breaking away. To effect this purpose the two spars connecting the ends were cut near each cell and jointed so that the angle of the cells, in relation to each other and to the wind, could be changed at will. Two cords were used to limit and adjust this motion. The rear cell was weighted with a half pound of lead and the cells were rigidly fastened, with both cells at an angle of about 10 degrees to the backbone. An extension or bowsprit, about 20 inches in length, was added to the lower side of the front cell, and the flying string was then attached to the extreme point of same. This arrangement proved to be very successful, the pull immediately becoming so light that the cord could be held in the hand even in a high wind. Thus modified, the kite has never shown the slightest tendency to dive or to tip sidewise when flying, or when coming down after it has broken loose, always preserving an even keel and sailing away with a steady, majestic motion like a balloon, and landing softly on the ground without much injury to the kite.

Our kite floating at a good angle with all our available string, we determined at a future trial to see if we could not let out a full mile. Waiting for a suitable day, we finally had a perfect day, with a 15 mile breeze. Getting our reel into position and bracing the cells in line, everything being in readiness, we allowed the kite to go up.

It sailed away like a soaring bird, and rose as rapidly as we could let out the string. The large black boxes of the kite were nearly out of sight when it reached its full limit. After the 6,000 feet was all reeled off it flew at an angle of about 40 degrees, and probably would have carried up more line if we had possessed it. For added safety a short piece of strong, elastic cord was sandwiched in next the kite.

This event was much enjoyed by a large number of spectators, who assisted in winding in the cord. At no time was the pull so strong that the cord could not be easily held in the hand. This experiment took place at Great Diamond Island, in Portland Harbor, and after drawing in the kite to within about 300 feet of the ground, in order to test its capacity for being

towed, we took our apparatus aboard the steamer homeward bound, with the kite still flying in the air. Taking our position on the deck, abaft the smokestack, we succeeded in making the roundabout trip to the city without any trouble; the steamer meanwhile turning to all points of the compass in making stops at her landings. We were able to go ashore at the city before hauling down the kite and closing our day's sport.

The Multiplane Folding Kite.—Finding most kites rather troublesome to pack for transportation, the writer has invented a kite with triangular sails, having the frames jointed, so that the sails can be folded back against a central keel. The sails are also adjustable in angle. There are eight of these sails superposed in pairs, two at each end of the keel, or backbone. The arms present sharp edges to the wind. The keel is also jointed at the center. By folding the sails back, disjoining the keel and putting the two parts side by side, a large kite can be slipped into a paper or cloth bag, making an unobtrusive package, easily carried under the arm.—Charles H. Lamson.

For the foregoing matter and cuts we are indebted to the Aeronautical Annual for 1896.

Beards and Bacteria.

The bacteriology of the beard has not yet, so far as we are aware, been exhaustively studied; this might be a new world for one of our young Alexanders of pathology to conquer. That it is possible that disease can be carried in the manner suggested will hardly be denied, but we cannot say that we think the danger so great that doctors need sacrifice their beards on the altar of hygiene. Most will think even the careful sterilization of the beard on leaving a sick room a counsel of perfection. If the scrupulous hygienist thinks such a precaution necessary, he should be consistent,

and insist on doctors shaving their heads and even their eyebrows. How would our professional sisters like this? To live in the odor of antiseptic sanctity we should, after due purification, clothe ourselves in cotton wool, wrap our heads in sterilized gauze, and go about like veiled prophets of Khorassan.—British Medical Journal.

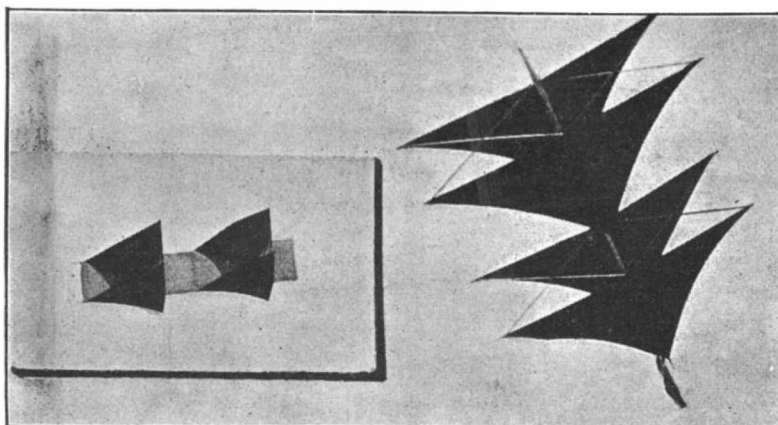

LAMSON'S MULTIPLANE FOLDING KITE.

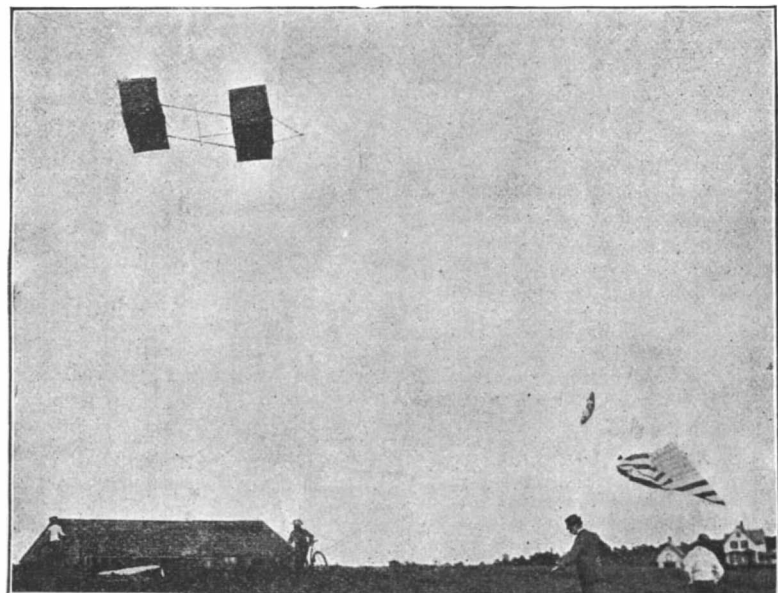

LAMSON'S MODIFIED HARGRAVE KITE.

6 feet; depth, 2 feet; distance between the cells, 4 feet 4 inches, making the full outside dimensions of the kite 6 feet wide and 8 feet 6 inches in length. Material of frame, straight grained American spruce. The dimensions of the two strips constituting the backbone were ¾ by ½ inch. The cross braces for the cells were made elliptical in section, sharp edges ex-

RECENTLY PATENTED INVENTIONS.

Engineering.

LOCK TO RAISE AND LOWER VESSELS.

—Franklin H. Bullis, Brooklyn, N. Y. This is a lock especially designed for use at the entrance to seaport harbors, and is so constructed that in passing through it the speed of vessels need be but slightly or not at all retarded. There are dikes and embankments at opposite sides of the channel, in which are larger and smaller locks side by side, the two central locks being the larger, and the ends of each lock being closed by transversely movable gates. Each lock is provided with wickets permitting the admission or draining of water to and from the locks without opening the gates.

FURNACE—Michael J. Graney, Allegheny, Pa. This furnace has a combustion chamber into which opens a mixing chamber provided with a gas supply near its bottom, a hot air chamber being located under the combustion chamber and connected at its rear end with a cold air inlet. The hot air chamber has in its front a downwardly extending passage leading to the bottom of the mixing chamber. The furnace is designed to be very simple and durable in construction, and to utilize all gases to effect the most complete combustion.

Railway Appliances.

CAR COUPLING.—Daniel Collen, In-

wood, Canada. This is a strong and simple coupler which couples automatically as the cars come together, and comprises a gravity locking device and swinging knuckle, a spherical body in a chamber in the coupling head automatically moving beneath the locking device after it is raised, and being also adapted to move the knuckle to an open position when the locking device is released.

TRAIN PIPE CONNECTION.—Harrison Reed, Logansport, Ind. According to this improvement a depending support is attached to the end of the car, with two coupling head sections and a pipe section projecting from each one, the pipe and head sections being arranged one above the other, while there are two vertically movable crossheads on the support, and a lifting lever. The invention affords reliable means for automatically joining the steam or air pipes on cars, being readily adjustable to compensate for varying heights of car bodies from the track.

Electrical.

BRUSH FOR DYNAMOS AND MOTORS.—

Friedrich W. Kreinberg, Eisey, Prussia. Two kinds of brush are provided by this invention, one consisting of a conducting wire bundle, incased or hermetically closed by aluminum or similar soft material until used, another form of brush consisting of bundles of fine wires braided together and saturated with a lubricant, a wrapping of wire cloth surrounding the casing.

RAILWAY SIGNAL SYSTEM.—Joseph Irwin, Omaha, Neb. This is a sectional signal system designed to enable an engineer having a train on a section to instantly determine when a train enters the section. The track rails at each station of the system are divided into pairs of insulated sections, two of the pairs having one of their members grounded and arranged to be connected by longitudinal bridging, in combination with a signal device, line wire and battery, forming three separate circuits, one setting the danger signal at the station in front, the other obliterating the danger signal at the rear, and the other setting rearwardly facing danger signals of intermediate stations.

Mechanical.

DIE FOR DROP PRESSES.—William H. and William J. Clark, Salem, Ohio. This invention provides for an extremely strong construction of the female die, the body of which is made of tough cast metal and is provided with recesses or mortises adapted to receive a shaping block section made of forged or cast steel or chilled iron. Between the shaping block section and the body of the die is interposed a cushion of Babbitt, zinc, or other metal, so that the blocks will not crack under the impact of the die.

WIRE GLASS MANUFACTURE.—Carl S. Weber, New York City. According to this improvement a carriage is arranged to be moved over the table on which is poured the molten glass to form a sheet, a wire feed and pressing roller being journaled in the front part of the carriage, and a pressing roller in the rear of the feed, a finishing roller being journaled in a frame pivoted on the carriage in the rear. The wire netting is fed to the glass and simultaneously subjected to a rolling pressure whereby it is pressed completely beneath the surface.

Agricultural.

CORN HARVESTER.—Wilson W. Smith, Fritchton, Ind. This machine, styled by the inventor the "eclipse harvester," is adapted to be drawn between two rows of corn to cut and deposit it in piles ready to be tied into bundles. The harvester car carries the bundles from shock to shock, and the attendant has to walk only eight hills to set up a shock. The machine is of simple and inexpensive construction and requires but one operator.

COTTON HARVESTER.—Clarence W. Edgar, Toledo, Ohio. This is a machine in which a rotary gathering device takes the cotton from the bolls, aided by a pneumatic system, by which the cotton is conveyed to a receiver. The gatherers are composed of convergent rotary spindles, a parallel suction tube inclosing one side of the peripheries of the spindles, which have a surface of card clothing. The slowly revolving picker spindles pass by the sides of the stalks as the machine is drawn along, entering among the limbs, allowing the pickers opportunity to gather the open cotton.

STRAW STACKER.—Peter Knapp, assigned to John Ten Barge, St. James, Ind. This is an improvement in machines for stacking hay or straw by means of a pneumatic tube, the invention providing a low-lying derrick or hoisting apparatus which may be readily used in barns and other buildings, the pneumatic

tube being vertically adjustable and operated laterally by power, and its sweep controlled, and an automatically operated reversing mechanism being provided. The machine is strongly made and inexpensive.

Miscellaneous.

CHOKE FOR GUNS.—Randolph P. Cory, St. Louis, Mo. This is a separate attachable choke, which may be used or removed at pleasure. The choke section has a band portion which fits over the muzzle of the gun, and on this portion are studs engaged by eyes on yoke arms of a latching device which engages a catch fixed to the gun barrel. The yoke arms may be sprung off the studs to permit the use of the same yoke with different choke sections, several of which may be carried in the pocket.

BOTTLE REFILLING PREVENTION.—John J. Walsh, Yonkers, N. Y. This inventor provides a cap whereby the mouth of a bottle may be sealed without the aid of a cork, permitting the contents to be poured out through the cap, although the cap prevents the refilling of the bottle. The cap has a duct at one side and apertures to a main chamber in which is a gravity valve, a movable weight being located in the cap over the valve, while a temporary seal locks the valve in closed position.

CARPET STRETCHER.—Courtland A. Chamberlain, Canton, N. Y. This is a simple device by means of which a carpet may be stretched and held in stretched position while being tacked or nailed. A plate or board is provided with prongs to engage the carpet, and a standard on which is pivoted a lever is flexibly connected with and adapted to move the plate to stretch the carpet.

SASH FASTENER.—George W. Gardner and Lewis Appleton, Philadelphia, Pa. A bead of the window frame, according to this improvement, is provided with a rack, and on the bottom rail of the sash, at the edge near the rack, is a casing in which is a bolt movable to engage the rack, the bolt being actuated by a rod which extends to a thumb plate and handle centrally located on the bottom rail. The sash may be raised and lowered, or locked in any desired position, by taking hold of the handle and pressing upon the thumb plate, using only one hand.

BEDDING VENTILATOR.—Allan Fraser, Brooklyn, N. Y. This device consists of a tubular body with flanged outer end and a cap fitting snugly on its inner end, the bottom of the cap being open, and a perforated section being held in the body. The device is adapted to be pressed into and be self-fastening in mattresses, beds, bolsters, etc., to effect the thorough ventilation of the filling, prevent its usual tendency to pack and adhere together, maintaining it sweet and wholesome and keeping it elastic.

FAN.—Max Rubin, Brooklyn, N. Y. This invention provides an improvement in pocket fans in which the body of the fan is folded between receiving arms when not in use. By means of the improvement the receiving and retaining arms are held rigidly locked when the fan is opened, having the same solidity as though the arms were integral, the retaining device acting to securely hold the fan in closed or open position. The fan is also held more closely folded than possible heretofore, the bulk of the handle being decreased.

COFFEE POT.—Herbert Nicholson, Red Lodge, Montana. This invention is for a perforated receptacle to hold the coffee or tea within the pot in such manner as to insure its thorough saturation and the obtaining therefrom of the greatest flavor and strength, while the holder is removable without opening the lid proper, thus taking out the coffee grounds or tea dregs without emptying the pot. The pot, with its holder and screening devices, may be readily cleaned.

SIRUP PITCHER.—Harry Noice, Hyde Park, North Dakota. This is an improvement in pitchers which have a channel or way outside the pouring lip to receive the drippings and return them to the pitcher. A removable shell, forming a passageway to receive the drippings, is inserted in the neck, and there are two covers, one for the shell and one for the pitcher neck, the cover for the shell being opened and closed by the movement of the cover for the pitcher neck. The construction is simple, preventing all entry of dust, etc., and keeping the sirup pure and clean.

AUTOMATIC FIRE EXTINGUISHER.—Edward Livingston, New Orleans, La. This is an improvement on a formerly patented invention of the same inventor, and provides for pipes near the ceilings in buildings, each of the pipes having one or more fusion valves arranged to open when the temperature reaches about 160°, when fire-extinguishing fluid under pressure is discharged. Connected with the distributing pipe is a vessel connected with a supply tank, a liquid sealed gravity valve in the vessel controlling the supply of a gas-generating substance.

SURGICAL OPERATING TABLE.—Richard Kny, Brooklyn, N. Y. According to this improvement a longitudinally slotted table top is loosely connected to a frame and adjustable to various inclinations, a gutter being secured to the top to move therewith. The table is arranged to be easily kept clean, and to permit the operator or nurse to conveniently manage the various parts, to move a patient into any desired position.

VETERINARY SPECULUM.—Michael McNally, St. Louis, Mo. This is an improvement in implements for holding open the jaws of horses, etc., for examining the throat or administering medicine, and comprises pivoted sections having bits adapted to enter and bear on the jaws, the frame having a convenient locking device for holding its sections rigidly in position after they have been adjusted.

Designs.

DISPLAY STAND.—Ernest Greene, New York City. This stand comprises a polygonal casing with superposed panels defined by ornamental framework, there being a dome of ornamental metal work and an ornamental finial.

BRACKET.—Dewitt C. Bowen, Kansas City, Mo. This is a double bracket of substantially X shape, the members being curved and terminating in horizontal surfaces at top and bottom.

NOTE.—Copies of any of the above patents will be furnished by Munn & Co., for 25 cents each. Please send name of the patentee, title of invention, and date of this paper.

Business and Personal.

The charge for insertion under this head is One Dollar a line for each insertion: about eight words to a line. Advertisements must be received at publication office as early as Thursday morning to appear in the following week's issue.

Marine Iron Works. Chicago. Catalogue free. For mining engines. J. S. Mundy, Newark, N. J. "U. S." metal polish. Indianapolis. Samples free.

Presses & Dies. Ferracute Mach. Co., Bridgeton, N. J. Screw machines, milling machines, and drill presses. The Garvin Mach. Co., Laight and Canal Sts., New York. Emerson, Smith & Co., Ltd., Beaver Falls, Pa., will send Sawyer's Hand Book on Circulars and Band Saws free to any address.

Cripple Creek.—Complete history of the great gold camp, with our big 56-col. paper 3 mos. for 25c. in stamps. Illustrated Weekly, Denver, Colo.

\$100 Only! and upward needed to pay patent and start manufacture of a number of inventions. Address: Inventor X, SCIENTIFIC AMERICAN.

Mechanical inventions practically developed. Working drawings and estimates furnished. Terms reasonable. F. Hepburn, 34 Elm St., Newark, N. J.

The best book for electricians and beginners in electricity is "Experimental Science," by Geo. M. Hopkins. By mail, \$4, Munn & Co., publishers, 361 Broadway, N. Y.

For the original Bogardus Universal Eccentric Mill. Foot and Power Presses, Drills, Shears, etc., address J. S. & G. F. Simpson, 26 to 36 Rodney St., Brooklyn, N. Y.

See if *Rome* is stamped on the bottom of your tea or coffee pot; if it is not, you will want the best next time and we will be making them for you. Rome Manufacturing Company, Rome, N. Y.

Send for new and complete catalogue of Scientific and other Books for sale by Munn & Co., 361 Broadway, New York. Free on application.

Notes & Queries

HINTS TO CORRESPONDENTS.

Names and Address must accompany all letters, or no attention will be paid thereto. This is for our information and not for publication.

References to former articles or answers should give date of paper and page or number of question. **Inquiries** not answered in reasonable time should be repeated; correspondents will bear in mind that some answers require not a little research, and though we endeavor to reply to all either by letter or in this department, each must take his turn.

Buyers wishing to purchase any article not advertised in our columns will be furnished with addresses of houses manufacturing or carrying the same.

Special Written Information on matters of personal rather than general interest cannot be expected without remuneration.

Scientific American Supplements referred to may be had at the office. Price 10 cents each.

Books referred to promptly supplied on receipt of price.

Minerals sent for examination should be distinctly marked or labeled.

(6758) G. C. G. asks how to drill or bore

a glass shade. A. To drill a quarter inch hole in a glass shade, make a hole in a piece of wood or metal of the size that you desire to drill in the glass. Fasten it with beeswax upon the glass for a guide. A piece of brass or copper tubing, quite thin, is supplied with emery (No. 100) and water and twirled between fingers, or with a bow string. This will cut a hole in a few minutes. You can feed the emery and water a little at a time through the tube. The sketch will give an idea as to the principle.

(6759) G. G. asks: What kind of glue or cement can I use that will dry quickly and very hard and tough when thickly applied to several sheets of paper? I have tried Le Page's glue and Major's cement. The latter dries hard enough, but not quick enough. I wish to use it on an ordinary platen printing press for embossing purposes. A. Ordinary flour paste is usually used for the purpose you mention. A small percentage of good glue added to the paste might improve it.

(6760) L. S. asks: 1. How many and what kind of battery will it take to each 6 candle power incandescent electric lamp to give a steady and bright light for six consecutive hours each night, and, also, how often will the batteries need refilling? A. Use 5 cells secondary battery. Address the Electric Storage Battery Company, Drexel Building, Philadelphia, Pa., for same. 2. What kind of battery will suit best for an induction coil? Can you give me a receipt to prepare carbon paper? A. Melt 10 parts lard, 1 part of wax, and mix with a sufficient quantity of fine lampblack. Saturate unglazed paper with this, remove excess and press.

(6761) X Ray says: 1. I desire to charge a series of Leyden jars with a large induction coil, and when charged, wish to employ the stored current to work a second induction coil. Should the second or discharge coil be in the circuit while the series are being charged, or if put in afterward, will the current discharge in the manner I anticipate, or in one large spark? A. It must be out of circuit. The discharge will appear as a single spark. Of course, it will really be oscillatory. 2. Can you give me the formula for substances that possess fluorescent qualities? A. See our SUPPLEMENT, Nos. 318 and 351, and for luminous paint, Nos. 229, 497, 922, and 939.

3. How can I determine when the Leyden jars above referred to are fully charged? A. Use a pith ball electro-scope, with a scale to measure divergence of the balls. Determine by experiment the divergence corresponding to the maximum sparking distance.

(6762) E. R. L. asks: 1. Have articles been published in SCIENTIFIC AMERICAN or SCIENTIFIC AMERICAN SUPPLEMENT concerning telephones? Method of wiring wanted most. If so, what numbers? A. Yes; very numerous and interesting ones. See our SUPPLEMENT catalogue and consult the query printed below. 2. Articles about simple calculations in electricity. What numbers? A. For these we refer you to Sloane's "Arithmetic of Electricity," which we can supply for \$1 by mail. 3. Can back numbers of SCIENTIFIC AMERICAN and SCIENTIFIC AMERICAN SUPPLEMENT be obtained? A. All of the SUPPLEMENTS and the SCIENTIFIC AMERICAN for a number of years back, at 10 cents each, by mail.

(6763) H. M. writes: I am in want of a telephone, good for a distance of 400 or 500 feet. I should prefer a simple one which does not require a battery. Please give me information so I can procure circulars and descriptive catalogues. A. We refer you to our SUPPLEMENT, Nos. 142, 163, 191, 425, 500, 501, 502, 508, 856, 966, and others, for telephones.

(6764) W. W. M. asks: 1. What objections are there, if any, to a caustic potash battery? A. Low potential. 2. How does its economy compare with that of other batteries? A. Very well. 3. Can the caustic potash solution be made from wood ash lye? How? A. Yes; by treating with caustic lime, settling, and decanting. Better use caustic soda. 4. How can one tell when the solution is down to saturation? A. Weigh the caustic soda, so as to get a 30 per cent solution.

(6765) M. N. asks: Would you be so kind as to answer in your Notes and Queries whether the motor (SUPPLEMENT, No. 761) will stand 110 volts if the field is wound with No. 27 wire and the armature with No. 30; and will it stand 220 volts if the field is wound with No. 30 and the armature with No. 33 wire? A. A motor is made to stand a current, not merely by the size of the wire, but by the amount of wire of the specified size, and by the counter E.M.F. of the armature. Windings must be differently calculated according to whether a motor is shunt or direct wound.

(6766) W. G. M. asks: Can the light from a Crookes tube be seen? If so, why is it called non-luminous? I don't see how it could be light without being luminous, or how it could cast a shadow to take a picture. A. The tube gives fluorescent light, but, in X ray photography, rays of unknown nature and absolutely invisible and non-illuminating are employed. We suggest that you refer to our SUPPLEMENT, Nos. 181, 189, 213, 244, 792, 795, 905, 980, and 1050, and to the recent numbers of the SCIENTIFIC AMERICAN, especially those of February 15 and 22 and March 7.

(6767) G. G. writes: I have two copper (insulated) wires stretched parallel to each other and about 4 inches apart, from my house to the barn, which make quite loud sounds on still, cold nights. Can you tell me cause or the theory of the sound? A. It is produced by the wind. "Antihums," or India rubber packed attachments, are sold, designed to prevent the sound.

(6768) E. D. asks: Could the dynamo described in SUPPLEMENT, No. 161, be run as a motor, power being supplied from a battery? If so, could the armature be made of sheet iron punchings? A. It can be run as a motor. The drum armature for it is described in our SUPPLEMENT, No. 599. It is better than the two-pole armature.

(6769) Ralph asks the best steel to use in building a small magneto-generator, and the process to go through to get the best results. A. Use good tool steel. It is better to buy your magnets ready made. They are sold for your purpose as "machine magnets."

(6770) K. G. G. writes: 1. I am in a position to have the use of vacuum pump and sulphuric acid. How should I connect up the necessary apparatus to freeze water? A. Simply connect your flask to the system, and maintain a vacuum above the water. Wrap the flask up in a thick non-conducting covering. 2. What is meant by the term monocyclic system of electrical distribution? How does this system differ from the ordinary direct current system? What is the nature of the current? A. A simple alternating current, going first in one direction and then in another. 3. How can I test clay to know what percentage of aluminum it contains? A. By a chemical analysis.

(6771) C. W. E. asks: 1. Please indicate the pronunciation of Roentgen. A. Approximately, Runtgen, the g hard. 2. Our school building is heated by the hot air system. From the registers on many days an electric spark may be obtained; also from the metal portions of the seats or chairs, and sometimes when two persons clasp hands they feel an electric shock. Will you explain the cause of the same? A. The air is so dry that static electric excitation is easily maintained. The indications are that provision should be made for moistening the air. Your hot air system seems defective in that regard.

(6772) W. C. M. asks: Could you tell me how to wind the 8 light dynamo for 110 volts? Also, if I could do it by winding the armature different, but leaving fields the same (wound with No. 16 gage)? A. You could approximate to your requirements by using wire about one-third smaller in cross area on the field and armature. To change one and not the other would give poor results. Sloane's "Arithmetic of Electricity," \$1, by mail, gives such calculations.

(6773) J. E. P. asks whether he can remagnetize the permanent magnets to a telephone magneto that have lost their magnetism by the magneto having been run at too high speed for a long period. Can it be done by a battery current? Will the magnets have to be retempered? They still retain some magnetism, but not enough. A. You can remagnetize the magnets with a coil and strong current, or, perhaps, by simply touching to the poles of a dynamo field, and drawing away slowly, without axial change. Retempering is not needed.

(6774) M. J. B. asks: Can a 3 to 5 horse power motor described in SUPPLEMENT be wound to run

on an arc light circuit? Will you give changes to make? A. It is not practicable to do what you describe, partly from considerations of safety and partly from the effect of the motor on the circuit. Winding for the current of the circuit, so as to get counter E.M.F. and resistance enough to represent an arc lamp, is the basis of the solution. Do not try it.

(6775) C. S. H. asks: What lengths of Nos. 18, 26, and 36 copper wire have a resistance of one ohm? A. Approximately, 153 feet, 41 feet, and 2 3/5 feet respectively.

(6776) H. M. B. asks why the X rays are so named. A. We take it that X is used to indicate the unknown feature in the rays. X is the algebraic symbol of an unknown quantity.

(6777) E. D. asks: How small can a dynamo be made which will generate a sufficient current to supply one 3 candle power incandescent lamp, and of what voltage and amperage would it be? A. Special dynamos have to be calculated. The dynamo shown in SUPPLEMENT, No. 161, with the drum armature shown in No. 599, is approximately the size. A 3 candle power lamp rates at—ohms 3 1/2 to 4 1/2, volts 5 1/2 to 7, amperes 1 to 1 1/2.

(6778) J. W. asks: Can you tell me why weakening the field magnets of a motor increases its speed? A. It weakens the field, and hence reduces the counter E.M.F. due to any specified armature speed.

(6779) O. S. writes: 1. I want to erect a lot of grape trellises, handy to the house that I live in. Would like to use a lot of old one inch gas pipes. Would the gas pipes cause danger from lightning, or would they be a preventive or safety against lightning? A. They will be an element of safety, if connected to the ground; otherwise, they will be without effect one way or the other. 2. Suppose a tunnel is driven 130 yards in a hill. The hill is 90 feet high at the head of the tunnel, up through the ground to the surface. The hill has an even slope all the way. How many yards would it be from the tunnel mouth to a peg in the ground directly over the head of the tunnel? A. Nearly 134 yards.

(6780) M. S. P. writes: In building a storage battery, by laying a sheet of coated lead plate on the bottom of a jar, then a sheet of some insulating substance, then a sheet of lead, and so on, alternate plates connected to lead rods running to the top of the cell, what is the best substance to use between the lead plates? I thought of using asbestos paper, but it is very easily torn when wet. A. Asbestos paper is excellent and its fragility will not militate against it, because it will not be materially disturbed unless you overcharge too vigorously, so as to cause strong evolution of gas. Flannel has been used, but it decays.

(6781) W. A. H. asks: Can the cores of the field magnets in the small motor described in SUPPLEMENT, No. 641, be made of cast iron, and, if so, what proportions? A. Yes; follow the size given, or, if possible, make it a little thicker than shown.

(6782) Engineer writes: If I stand on a glass stool, I cannot be hurt by touching a high power electric current. If I am standing on the earth, I am killed. How does the electricity find out I am insulated? Does the electricity stop at my hands, because it has seen that the stool will stop it? A. The entire surface of the body is charged as you stand on the insulated stool. When ground is connected, the current, as such, passes through the body, with the effects of a more or less severe, possibly fatal, shock. The charge does not stop at the hands, but extends over the entire surface of the body.

TO INVENTORS.

An experience of nearly fifty years, and the preparation of more than one hundred thousand applications for patents at home and abroad, enable us to understand the laws and practice on both continents, and to possess unequalled facilities for procuring patents everywhere. A synopsis of the patent laws of the United States and all foreign countries may be had on application, and persons contemplating the securing of patents, either at home or abroad, are invited to write to this office for prices, which are low, in accordance with the times and our extensive facilities for conducting the business. Address MUNN & CO., office SCIENTIFIC AMERICAN, 361 Broadway, New York.

INDEX OF INVENTIONS

For which Letters Patent of the United States were Granted

March 3, 1896,

AND EACH BEARING THAT DATE.

[See note at end of list about copies of these patents.]

Table listing inventions with names and patent numbers, including items like 'Acid and obtaining it, citricphenetidin, B. R. Selbert' and 'Air brake signal, J. P. High'.

Table listing inventions with names and patent numbers, including items like 'Book lock, E. E. Rogers' and 'Book, mechanical cash, A. D. Smith'.

Table listing inventions with names and patent numbers, including items like 'Hammock chair, W. W. Blair' and 'Handbook, merchandise, H. F. Dalton'.

Table listing inventions with names and patent numbers, including items like 'Stethoscope, A. R. Mitchell' and 'Stone saw, circular, A. Mills'.

DESIGNS.

Table listing designs with names and design numbers, including items like 'Bottle, L. W. Merriam' and 'Button, D. C. Fauss'.

TRADE MARKS.

Table listing trade marks with names and design numbers, including items like 'Bicycles, McKee & Harrington' and 'Bicycles, velocipedes and horseless carriages, their parts and attachments, L. Straus & Sons'.

Advertisements.

ORDINARY RATES.

Inside Page, each insertion - - 75 cents a line
Back Page, each insertion - - - \$1.00 a line

For some classes of Advertisements, Special and Higher rates are required.
The above are charges per square line—about eight words per line.

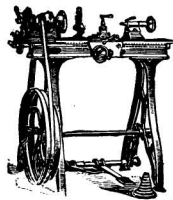

Star Lathes
Foot Power
Screw cutting
Automatic Cross Feed
9 and 12 inch Swing.

ACETYLENE GAS AND CARBIDE OF calcium.—All about the new illuminant, its qualities, Chemistry, pressure of liquefaction, its probable future, experiments performed with it.

POWER & FOOT LATHES SHAPERS, PLANERS, DRILLS MACHINE SHOP OUTFITS, TOOLS SEBASTIAN LATHÉ CO. 120 CULVERT ST. CINCINNATI, O.

LATHES Foot and Power. Screw Cutting Drilling and Grinding. Milling and Gear Cutting Attachments. W. H. MANSFIELD, 22 Artizan St., New Haven, Conn.



THE CURTIS Water Pressure Regulator
For Hotels and Public Buildings, Water Meters, Hydraulic Elevators, etc.

HIGH SPEED INDICATOR
May be run at highest speed required without heating. Reads either right or left. 0 mark may be instantly moved to starting point. Working parts incased.

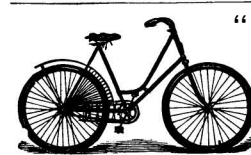

SWELL NEWPORT High-Grade Bicycles.
Large Manesman tubing, tool steel barrel hubs, barrel crank hanger. All turned parts finest quality tool steel.

S. & F. patent adjustable handle-bar. Any position obtainable without dismounting or the use of a wrench. SNYDER & FISHER BICYCLE WORKS, Little Falls, N. Y.

THE ONLY PERFECT Cycle Seat
Patented Demand this Seat. Insist upon it! Any dealer will get it for you. Can be widened to fit any rider and adjusted to any pitch.

Bicycle Pumps
15 Different Styles. HAND PUMPS, FOOT PUMPS, FLOOR PUMPS, POWER PUMPS. "CYCLONES" ARE BEST.

IN STORM OR CALM YOU CAN RELY UPON THE Pancoast Ventilator & Chimney Cowl

GATES ROCK AND ORE BREAKERS
OVER 3000 IN USE THROUGHOUT THE WORLD. GREATER CAPACITY USING LESS POWER THAN ANY OTHER ON EARTH.

"RAPID" TIRE MENDER. Quick, Sure, Easy.

Needs no strength or special skill; a lady or child can operate. Single or double tube tires repaired. Time one to three minutes.

SETS OF CASTINGS OF MODEL ENGINES CATALOGUES FREE. ALSO TOOLS, GEAR WHEELS & PARTS OF MODELS. GOODNOW & NIGHTMAN BOSTON

"My Well and what came out of it." A story by the novelist Frank R. Stockton. "Your Well and what will come out of it." By the

Pohlé Air Lift Pump
Bulletins to tell you will be sent on application. The Ingersoll-Sergeant Drill Co. Havemeyer Building, 26 Cortlandt Street, New York.

WELL DRILLING MACHINERY, MANUFACTURED BY WILLIAMS BROTHERS, ITHACA, N. Y. MOUNTED OR ON SILLS, FOR DEEP OR SHALLOW WELLS, WITH STEAM OR HORSE POWER. SEND FOR CATALOGUE ADDRESS WILLIAMS BROS. ITHACA, N. Y.

The "Climax" Stereotyper AND Moulding Press Combined. for making perfect Celluloid Stereotypes to be used in place of metal stereotypes. Also for making Rubber stamps. Should be in use in every printing office.

OUR MASTERPIECE! If ink and paper could show up polished steel and shining pearl as they are, every reader of the SCI. AM. would be unhappy until he owned the knife shown in this cut.



NEW YORK OFFICE OF RAND DRILL CO. Removed February 1st, 1896, to AMERICAN SURETY BUILDING, 100 Broadway, New York City.

PERFORATED METAL
FOR ALL USES
THE HARRINGTON & KING PERFORATING CO. CHICAGO, ILL. U.S.A. AND 284 PEARL ST. NEW YORK

ICE-HOUSE AND COLD ROOM.—BY R. G. Hatfield. With directions for construction. Four engravings. Contained in SCIENTIFIC AMERICAN SUPPLEMENT, No. 519. Price 10 cents.

DO YOUR OWN PRINTING
\$5. PRESS for cards, circulars, &c Press for printing a small paper, \$40. Save money! Make money printing for others!

Handsomest, Highest Grade, Fast, Light, Strong, Highest Award World's Fair, \$100. Also Overland Cycles, \$45, \$55, \$75. Agents wanted, exclusive territory. Estab. 1864. Catalog free. CYCLES RUN EASY ROUSE, HAZARD & CO. MAKERS 16 G ST., PEORIA, ILL.

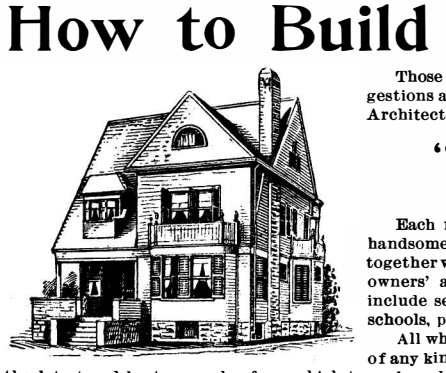

How to Build a Home
Those intending to build will find the very best practical suggestions and examples of Modern Architecture in the handsomest Architectural Magazine ever published.

SINTZ GAS ENGINE CO. GRAND RAPIDS, MICH., U. S. A.

Manufacturers of the Sintz Stationary and Marine Gas and Gasoline Engines. Especially adapted for Boats and Electric Lighting.

MANUFACTURE OF STARCH FROM Maize.—By J. Krieger. Full details of the process. With one illustration. Contained in SCIENTIFIC AMERICAN SUPPLEMENT, No. 1012. Price 10 cents.

"Pacific" & "Union" Gas & Gasoline ENGINES. Marine and Stationary. 1 to 75 h. p. Safe, Simple, Economical. The GLOBE GAS ENGINE CO. Merion Av. & 49th St. Philadelphia, Pa.

"WOLVERINE" GAS AND GASOLINE ENGINES, STATIONARY AND MARINE. The "Wolverine" is the only reversible Marine Gas Engine on the market. It is the lightest engine for its power.

HALF A CENTURY OF CYCLES.—AN interesting history of the cycle from its origin up to the present time. The first crank-driven bicycle. The "bone-shaker" and its successors. The tricycle. The modern wheel. Cycle building a science. Points of improvement. The pneumatic tire. A hand and foot cycle.

If you want the best Lathe and Drill BUY WESTCOTT'S GNUGKS Strongest Grip, Greatest Capacity and Durability. Cheap and Accurate. Westcott Chuck Co., Oneida, N. Y., U. S. A. Ask for catalogue in English, French, Spanish or German. FIRST PRIZE AT COLUMBIAN EXPOSITION, 1893.

ELECTRICITY TAUGHT BY MAIL

Mechanics, Steam Engineering, Mechanical Drawing, Architecture, R. E. and Bridge Engineering, Plumbing, Heating, Mining, English Branches. Send for free circular, stating subject wish to study or your trade.

"A FAIR FIELD AND NO FAVORS." "Work in Sight" does not mean Absolutely Visible Writing—which WE HAVE on the

Daugherty's Visible

You send for All the Other Catalogues, and Then Send for a Daugherty on Trial. You will buy none other. Price \$75.00



THE DAUGHERTY TYPEWRITER CO. P. O. Box 1260 "C", PITTSBURG, PA. FACTORY AT KITTANNING, PA.

The Typewriter EXCHANGE, 1 1/2 Barclay St., New York. 156 Adams St., Chicago. 38 Court Sq., Boston. 818 Wyandotte Street, Kansas City, Mo.

WITH WORKSHOP EQUIP- YOUR WORKSHOP PED. With outfits of Barnes Wood and Metal Working FOOT POWER Machinery you can successfully compete with Factories that use steam power, both in quality and profit on product.

LIDGERWOOD CABLEWAYS HOIST AND CONVEY LOADS UP TO 20 TONS. SPANS UP TO 2,000 FEET. 150 LIDGERWOOD CABLEWAYS SOLD AND ERECTED. 20 of these Cableways used on the Chicago Main Drainage Canal.

A NEW PIPE WRENCH
Grips Quickly and Firmly, GALVANIZED as well as other Pipe, and will Not Crush it. Won't lock on pipe. Does not mar nut or highly polished fitting. Other features.

THE MISSES LISK'S IMPROVED PATENT CAKE TINS
Positively guaranteed Not to Leak. Butter. Easy to clean. We furnish with the tins our standard measuring cup, a correct measure for all recipes.

THE ORNAMENTAL IRON INDUSTRY.—Description of the method of manufacturing wrought iron into ornamental and artistic forms. With 9 illustrations. Contained in SCIENTIFIC AMERICAN SUPPLEMENT, No. 1020. Price 10 cents.

VANUZEN STEAM PUMP THE BEST IN THE WORLD. Pumps Any Kind of Liquid. Always in Order, never Clogs nor freezes. Every Pump Guaranteed. 10 SIZES. 200 to 12000 Gallons per Hour. Cost \$7 to \$75 each. Address THE E. W. VANUZEN CO., 102 to 108 E. Second St., Cincinnati, O.



REVISED AND ENLARGED. 120 Pages and 110 Superb Cuts added.

Just the thing for a holiday present for any man, woman, student, teacher, or anyone interested in science. In the new matter contained in the last edition will be found the Scientific Use of the Phonograph, the curious optical illusion known as the Anorthoscope, together with other new and interesting Optical Illusions, the Optical Projection of Opaque Objects, new experiments in Projection, Iridescent Glass, some points in Photography, including Hand Cameras, Cane Cameras, etc. Systems of Electrical Distribution, Electrical Ore Finder, Electrical Rocker, Electric Chimes, How to Color Lantern Slides, Study of the Stars, and a great deal of other new matter which will prove of interest to scientific readers.

MUNN & CO., Publishers. Office of the SCIENTIFIC AMERICAN, 361 BROADWAY, NEW YORK.

Founded by Mathew Carey, 1785.

HENRY CAREY BAIRD & CO. INDUSTRIAL PUBLISHERS, BOOKSELLERS & IMPORTERS...

The Part Played by Accident in Invention and Discovery.

By Prof. Ernst Mach in January Monist. 50 cents. Chicago: The Open Court Pub. Co.

ASK YOUR DEALER FOR

W. L. DOUGLAS \$3. SHOE BEST IN THE WORLD.

If you pay \$4 to \$6 for shoes, examine the W. L. Douglas Shoe, and see what a good shoe you can buy for \$3.

OVER 100 STYLES AND WIDTHS, CONGRESS, BUTTON, and LACE, made in all kinds of the best selected leather by skilled workmen.

We make and sell more \$3 Shoes than any other manufacturer in the world. None genuine unless name and price is stamped on the bottom.

Ask your dealer for our \$5, \$4, \$3.50, \$2.50, \$2.25 Shoes; \$2.50, \$2 and \$1.75 for boys.

TAKE NO SUBSTITUTE. If your dealer cannot supply you, send to factory, enclosing price and 3c cents to pay carriage.

W. L. DOUGLAS, Brockton, Mass.

Advertisement for THE NEW DEPARTURE BELLS, featuring an image of a bell and descriptive text about its quality and availability.

TO MANUFACTURERS AND OTHERS Desiring a representative in Brazil. The undersigned represented Brazil at the World's Fair, Chicago, 1893.

EMPIRE BOILER CLEANER COMPOUND. We Don't Offer Gratuities, but our Circular will give you the information that will enable you to save Time, Trouble and Money.

AMERICAN PATENTS.—AN INTERESTING and valuable table showing the number of patents granted for the various subjects upon which petitions have been filed from the beginning down to December 31, 1894.

A.W. FABER. Manufacture Established 1761. LEAD PENCILS, COLORED PENCILS, SLATE PENCILS, WRITING SLATES, STEEL PENS, GOLD PENS, INKS, PENCIL CASES IN SILVER AND IN GOLD.

WARRANTED OAK DESKS. 38 inch, \$12.00; 48 inch, \$15.00; 54 inch, \$18.00; 60 inch, \$20.00.

ELASTIC ROTARY-BLOW RIVETING MACHINE. For riveting together various articles of hardware, bicycle chains, agricultural implements, mechanics' tools, sewing machine attachments, and almost every class of work where riveting is required.

MANUFACTURE OF BICYCLES.—A very comprehensive article giving the details of construction of every part of these vehicles.

THE IMPROVED PERFECTION CAKE TINS. Loose bottoms. "Don't leak." The groove prevents that. Require no greasing.

DAIMLER MOTOR COMPANY, BUILDERS OF Highest Grade Single and Twin Screw Launches. Safest, cleanest and speediest power boat built. No smoke or smokestack, no boiler, no electricity.

The Bartley Direct Running Saw Mill. Most complete, compact, and substantial Portable Saw Mill now on the market.

THE OBER LATHE. For Turning Axe, Adze, Pick, Sledge, Hatchet, Hammer, Auger, File, Knife and Chisel Handles.

MAGNETO BELLS. ALL KINDS OF PARTS OF TELEPHONES. ELECTRICAL SUPPLIES.

BUY TELEPHONES. That are good—not "cheap things." The difference in cost is little. We guarantee our apparatus and guarantee our customers against loss by patent suits.

HELLO, CENTRAL! Long Distance Granular Carbon Telephones! The "best" is the cheapest in the long run, and ours are the best.

RED CEDAR TANKS. CYLINDERS and CAISSONS—of Pine or Cypress—any size.

PATENTS. Messrs. Munn & Co., Solicitors of Patents, have had nearly fifty years' continuous experience.

65 Light Dynamo. In payments of \$10 per month. Hobart Electric Mfg. Co., Troy, Ohio.

INVESTORS. A Chicago company, manufacturing an article for which demand is large, will enter into negotiations to dispose of its English patents.

CHEAPEST DYNAMO ON THE MARKET. DO NOT SEND TO US. WE DO NOT MAKE IT. IF YOU WANT A FIRST CLASS DYNAMO AT A FAIR PRICE, WE CAN SUPPLY YOU.

MONITOR VAPOR ENGINE AND POWER COMPANY. 8 ERIE STREET, GRAND RAPIDS, MICHIGAN.

THE STURTEVANT PRESSURE BLOWERS. ALL SIZES AND STYLES. SEND FOR CATALOGUES.

THE NEW BRISTOL COUNTER. Registers an accurate account of work done on printing presses, grain tallies, weighing, measuring and other automatic machines.

INCUBATORS. Our 160 page, finely illustrated Combined Poultry Guide and Catalogue will tell you what you wish to know about PROFITS IN POULTRY.

INCUBATORS. Brooders, Vegetable and Clover Cutters. BONE AND GRAIN MILLS. A complete line of poultry supplies at lowest prices.

STEREOPTICONS. Lantern Slides. WE ARE MAKERS. Write for Catalogue M.

THE FISHER Patent Steam Pump Governors. For Steam Pumps Working under Pressure and Gravity Governors.

Something New in Photography. Send us a cabinet picture with 25c. or postal note, also 2-cent stamp for return mailing.

SCIENTIFIC AMERICAN DYNAMO. Description of a plain shunt-wound dynamo of simple construction, capable of supplying a current of from 60 to 75 110-volt incandescent lamps.

ALCO VAPOR LAUNCH. Engine and Helm Controlled from Bow. Latest improved and only 12 to 1 Motor now ready for the market.

SEND FOR CIRCULAR. No licensed Engineer or Pilot required. Speed and Safety guaranteed.

HE IS DEAD. To his own interest, who deals in Aras and Ammunition or who shoots a Rifle Pistol, or Shot Gun and has not a copy of IDEAL HAND BOOK, No. 7.

METAL and WOOD TOOLS WORKERS. FOOT POWER SCROLL SAWS, MORTISERS, LATHES, FORMERS, MACHINERY.

ICE MACHINES. Corliss Engines. Brewers' Ice Millers' Machinery. THE WILTON MFG. CO., 859 Clinton Street, Milwaukee, Wis.

EXPERIMENTAL & Model Work. E. V. BAILLARD, 106 Liberty Street, N. Y.

DEAFNESS CURED! THE DEAFNESS VAPORATOR. Deafness cured! Scientific principle. Satisfaction guaranteed.

SEND SAMPLE FOR ESTIMATE. ARTICLES IN WIRE, SHEET-METAL, IRON, STEEL, OR BRASS.

Incubators & Brooders. Best in the world, hot water, pipe system. Will hatch chicks when others fail.

SHOEMAKER'S POULTRY BOOK. 96 pages, printed in 6 colors. Birdseye view of largest Poultry Farm.

WANTING GOOD BRONZE PATTERN CASTINGS should write us. Our work is so good that patterns need but little attention to make them ready for use.

CARBORUNDUM. HARDEST ABRASIVE KNOWN. EMERY AND DIAMOND POWDER SUBSTITUTE.

HAWKINS' "Aids" to Engineers. EXAMINATIONS, with Questions and Answers, 5 1/2 x 7 1/2, leather, gilt edge, \$2. postpaid.

ELECTRICITY PAPERS. No. 1. How to Make a Dynamo. Price 10c. each. No. 2. How to Make a Telephone.

WOODEN TANKS. For Railroads, Mills and Manufactories. Builders of Steel Towers and Tanks.

FIRE BRICK FOR ALL PURPOSES. BROOKLYN FIRE BRICK WORKS. 85 Van Dyke Street, BROOKLYN, N. Y.

STEEL STAMPS & DIES FOR EVERY PURPOSE. STAMPS FOR MARKING, C.H. HANSON, A SPECIALTY.

MEN and WOMEN. Taught to make Crayon Portraits in spare hours at their homes by a new copyrighted method.

HOUGHS SECURITY CASH RECORDER. ENTIRELY DIFFERENT FROM A CASH REGISTER—IT ENABLES YOU TO TRADE AND PROVE EVERY TRANSACTION—A COMPLETE RECORD KEPT—INVALUABLE TO ALL KINDS OF BUSINESS.

BRASS BAND. Instruments, Drums, Uniforms, Equipments for Bands and Drum Corps.

ROPE. If you want any Rope for Transmission of Power. H. CHANNON COMPANY, 24-26 Market St., CHICAGO.

Advertisements.

ORDINARY RATES.

Inside Page, each insertion, - 75 cents a line
Back Page, each insertion, - \$1.00 a line
For some classes of Advertisements, Special and Higher rates are required.

The above are charges per agate line—about eight words per line. This notice shows the width of the line, and is set in agate type. Engravings may head advertisements at the same rate per agate line, by measurement, as the letter press. Advertisements must be received at Publication Office as early as Thursday morning to appear in the following week's issue.

21 Experts

compose the Bicycle Council that passes upon each detail of Columbia construction—engineers, metallurgists, designers, keen-eyed men of science. And they do no guessing. Back of them is one of the most complete Departments of Tests in this country. Such accurate scientific methods must produce standard machines.



Columbia
BICYCLES

Standard of the World.

\$100 Hartford Bicycles are next best.
To all alike. \$80, \$60, \$50.

The Art Catalogue of Columbia and Hartford Bicycles is free if you call upon any Columbia agent; by mail for two 2-cent stamps.

POPE MANUFACTURING CO.,
Hartford, Conn.

Branches and Agencies in nearly every town. If we are not properly represented in your vicinity let us know.

There's no doubt about the advisability of riding a wheel—the only question now is what wheel to ride.

Monarch

King of Bicycles,

represents cycle manufacture in its highest development. A wheel with which no fault can be found.

4 models. \$80 and \$100, fully guaranteed. For children and adults who want a lower price wheel the Defiance is made in 8 models, \$40 to \$75. Send for Monarch book.



MONARCH
CYCLE MFG. CO.,
Lake, Halsted and
Fulton Sts.,
CHICAGO.
88 Reade St.,
NEW YORK.

AGENTS WANTED FOR FINE TOOLS IN EVERY SHOP.
WRITE FOR CATALOGUE AND AGENCY.
C. H. BESLY & CO.
CHICAGO, ILL. U.S.A.

The American Bell Telephone Company,

125 Milk Street,
Boston, Mass.

This Company owns Letters-Patent No. 463,569, granted to Emile Berliner November 17, 1891, for a combined Telegraph and Telephone, covering all forms of Microphone Transmitters or contact Telephones.

"Work in Sight."

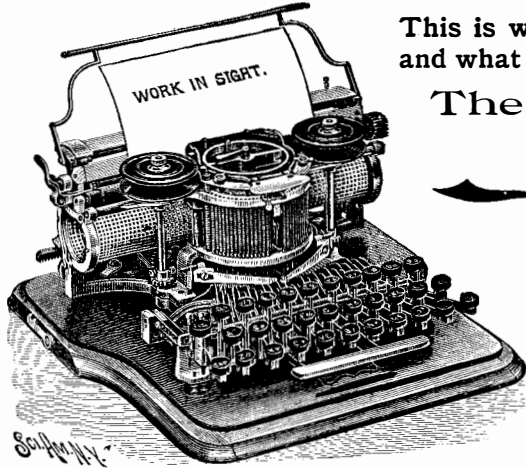

This is what every operator wants and what in its latest improvement

The No. 2
Hammond

now offers to every operator in a manner that excels all efforts in this line. In simplicity and ease of operation it stands alone.

THE HAMMOND TYPEWRITER CO., 401 East 62d Street, New York.

... WE ARE BUILDING ...

The Celebrated
"HORNSBY-AKROYD"
OIL ENGINE

The De La Vergne Refrigerating Machine Co.
FOOT E. 138TH STREET, NEW YORK.

There is hardly a USE OF POWER

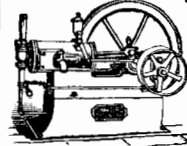

in Factory, Mill, Store, Office, Elevator, Creamery, or Shop—or on the Farm, the "CHARTER" is not now filling. It is also running Boats, Well Drills, Pumps, Dynamoes, Threshing Machines, etc. Of course it also uses Gasoline.

CHARTER GAS ENGINE CO., P. O. Box 148, Sterling, Ill.

BUNDY
STEAM
TRAP.



Has The Coal Combine Affected You?

The BUNDY STEAM TRAP will reduce your coal bills. It will save you from one to five dollars per day. Book "314" free.

A. A. GRIFFING IRON CO., NEW YORK

NEWAYGO AUTOMATIC CIRCUIT BREAKERS

Guaranteed to operate perfectly or no pay. Made for alternating or direct current. Any Voltage. Catalogue Free.
AUTOMATIC CIRCUIT BREAKER COMPANY, NEWAYGO, MICHIGAN, U. S. A.

Waverley Bicycles
The Most Copied in the World

DO YOU RIDE ONE?

If not, why not? No other wheels in the world stand so high in the estimation of cyclists, because Waverley's are built on honest value lines, and the purchaser receives full value for the investment.

ARE MADE IN THE LARGEST AND BEST EQUIPPED FACTORY IN THE WORLD.
INDIANA BICYCLE CO.
INDIANAPOLIS, IND.

SEND TEN CENTS IN STAMPS FOR A PAIR OF OUR NEW CARD COUNTERS.

AS WE HAVE SAID BEFORE...

Sterling Bicycles

NEED NO REPAIRS

—are "Built Like a Watch" and run as easy

Ride an Olive Green Sterling in '96

Our New Catalog is a beauty!

STERLING CYCLE WORKS
GENERAL OFFICES:
274-276-278 WABASH AVENUE
CHICAGO

Schoverling, Daly & Gales, 302 B'way, New York
Pacific Coast Branch, 314 Post St., San Francisco

Palmer Fabric

Makes a Tire ELASTIC EASY RIDING and FAST (taking less strength to propel)

Palmer Tires

Are Durable, GUARANTEED and Easy to Mend.

They are expensive, and only found on High-Grade Wheels.

MADE BY
Palmer Pneumatic Tire Co.
Chicago.

Facts About Pneumatic Tires mailed on request.

Patee Bicycles

Have dust-proof bearings that are dust proof, large tubing, 5 inch tread, latest pattern continuous cranks and crank shaft. Tubular hubs wide between spokes, and straight rear braces. In fact, are thoroughly modern in all respects. Built by men who have every facility that money can buy for the production of the best machine, backed by 18 years' practical experience.

PRICES \$60 and \$85.

AGENT WANTED in every town. Best seller made. Write for terms and discounts. PEORIA, ILLS.

ENGINES, Boilers and Machine Tools. New Machinery, and Second-hand. Send stamp for paper "Machinery & Supplies." W. P. Davis, Rochester, N. Y.

THE POPULARITY OF
Crescent Bicycles
IS UNIVERSAL.

SEND FOR CATALOGUE

WESTERN WHEEL WORKS,
BUILDERS
CHICAGO NEW YORK

PRIESTMAN SAFETY OIL ENGINE
"Phenomenally low in cost of operation."—Franklin Inst.
NEITHER Kerosene, NOT Gasoline
STEAM ENGINEER

Economical, Simple, Safe, Automatic. For Electric Lighting, Pumping, Milling, etc.

PRIESTMAN & COMPANY, Inc.
Front and Tasker Streets, - - Philadelphia

HARTFORD SINGLE TUBE TIRES

IF IT'S A HARTFORD TIRE IT'S RIGHT.

THE HARTFORD RUBBER WORKS CO.,
HARTFORD, CONN.
BRANCHES: NEW YORK AND CHICAGO.

JESSOP'S STEEL THE VERY BEST FOR TOOLS, SAWS, ETC.
Wm. JESSOP & SONS 129 91 JOHN ST. NEW YORK

The \$5.00
POCKET KODAK

EASTMAN KODAK CO.,
Sample photo and booklet for two 2-cent stamps.
ROCHESTER, N. Y.

COMPUTOMETER

Mistakes in Addition, Office Headache, and mistakes in carrying forward don't occur where the Computometer is used. It saves half the time in doing the work and all time looking for errors. Solves with great rapidity and absolute accuracy all arithmetical problems. Why don't you get one? Write for Pamphlet.

FELT & TARRANT MFG CO.
62-56 ILLINOIS ST., CHICAGO.

HARTFORD STEAM BOILER
HARTFORD, CONN.
INSPECTION AND INSURANCE CO.

At 1/4 Price Bicycles, Watches, Guns, Buggies, Harness, Sewing Machines, Organs, Pianos, Sales, Tools
Send for Catalogue
RIDE THE HUNTER CYCLES
HUNTER ARMS CO.
FULTON N. Y.

PRINTING INKS.
The SCIENTIFIC AMERICAN is printed with CHAS. R. NEU JOHNSON & CO.'S INK, Tenth and Lombard Sts., Philadelphia, and 47 Rose St., opp. Duane, New York