

# SCIENTIFIC AMERICAN

[Entered at the Post Office of New York, N. Y., as Second Class Matter. Copyrighted, 1887, by Munn & Co.]

A WEEKLY JOURNAL OF PRACTICAL INFORMATION, ART, SCIENCE, MECHANICS, CHEMISTRY, AND MANUFACTURES.

Vol. LVII.—No. 22.  
[NEW SERIES.]

NEW YORK, NOVEMBER 26, 1887.

[\$3.00 per Year.]

## ELECTRIC WELDING.

The invention of a new art and its reduction to a practical, commercial basis is an event of some importance in the world's history. It necessarily has more or less influence on a large circle of other arts and industries. The discovery of electrical induction, and the invention based on this discovery, by means of which mechanical energy is converted into electrical energy, has made electric illumination and a host of other commercial electrical applications possible. Among these applications, one of the most recent and interesting is that of the electrical welding of metals, invented by Professor Elihu Thomson, of Lynn, Mass.

The art of welding iron and steel by means of the heat of an ordinary fire is many centuries old, and it is perhaps one of those simple operations which would hardly be considered a subject for improvement; but the invention of Professor Thomson not only facilitates the welding of iron, steel, and such metals as have here-

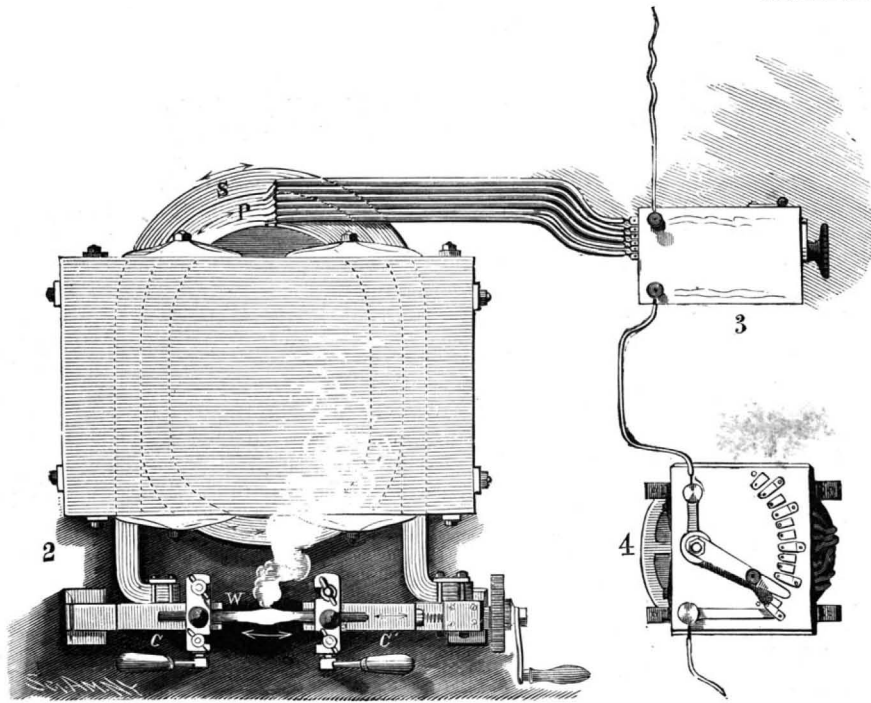

Fig. 2.—PLAN VIEW OF THE TRANSFORMER AND WELDING CLAMPS.

before been welded by the old time methods, but permits of the welding of cast iron, copper, brass, German silver, zinc, aluminum, and other metals which have generally been considered poor subjects for the welding process. Besides these, this new process has been successfully applied to the welding of unlike metals; iron and German silver, iron and brass, being examples.

The electrical welding process is not particularly adapted to job work, but in the regular manufactures, such as the making of chains, wood and iron working tools, the welding of carriage axles, the joining and repairing of shafting, the joining of wires in electric factories, the union of long pipes for coils for special purposes, the making or repairing endless bands, such as band saws, wheel tires, barrel and tank hoops, it finds its legitimate application. It also finds an extensive application in shops, for lengthening screw taps, drills, reamers, augers, in mending chisels and punches, length-

(Continued on page 345.)

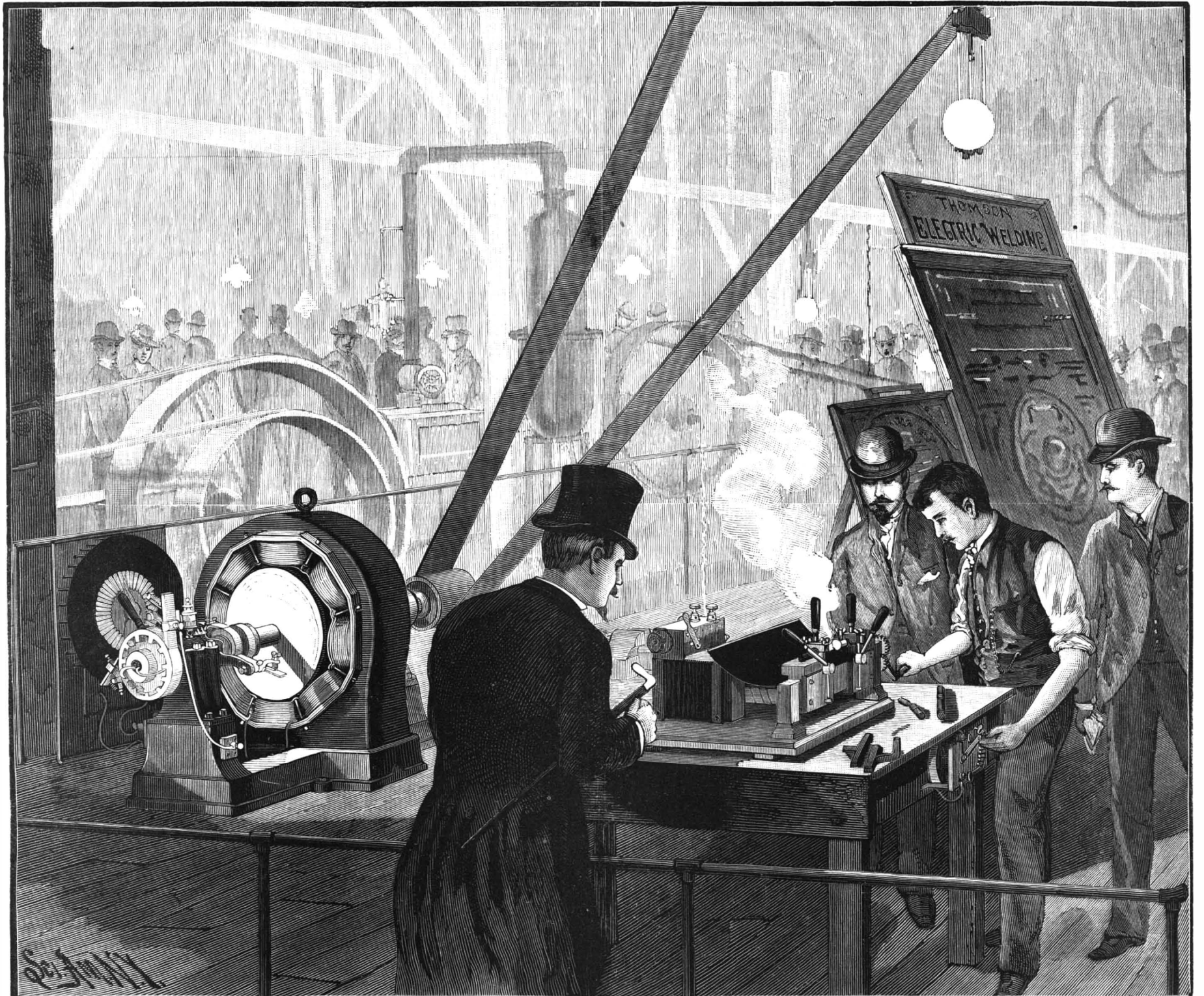

Fig. 1.—ELECTRIC WELDING AT THE AMERICAN INSTITUTE FAIR, NEW YORK.—PROFESSOR ELIHU THOMSON'S PROCESS.

Scientific American.

ESTABLISHED 1845

MUNN & CO., Editors and Proprietors.

PUBLISHED WEEKLY AT

No. 361 BROADWAY, NEW YORK.

O. D. MUNN.

A. E. BEACH.

TERMS FOR THE SCIENTIFIC AMERICAN.

One copy, one year, for the U. S. or Canada, \$3 00

One copy, six months, for the U. S. or Canada, 1 50

One copy, one year, to any foreign country belonging to Postal Union, 4 00

Australia and New Zealand.—Those who desire to receive the SCIENTIFIC AMERICAN, for a little over one year, may remit £1 in current Colonial bank notes.

Combined Rates.—The SCIENTIFIC AMERICAN and SUPPLEMENT will be sent for one year, to any address in U. S. or Canada, on receipt of seven dollars.

Australia and New Zealand.—The SCIENTIFIC AMERICAN and SUPPLEMENT will be sent for a little over one year on receipt of £2 current Colonial bank notes.

The SCIENTIFIC AMERICAN Export Edition is a large and splendid periodical, issued once a month. Each number contains about one hundred large quarto pages, profusely illustrated, embracing: (1) Most of the plates and pages of the four preceding weekly issues of the SCIENTIFIC AMERICAN, with its splendid engravings and valuable information.

NEW YORK, SATURDAY, NOVEMBER 26, 1887.

Contents.

(Illustrated articles are marked with an asterisk.)

Table listing various articles such as 'Ants, habit in, modification of', 'Aquariums for amateurs', 'Brick clay', etc., with corresponding page numbers.

TABLE OF CONTENTS OF SCIENTIFIC AMERICAN SUPPLEMENT No. 621.

For the Week Ending November 26, 1887.

Price 10 cents. For sale by all newsdealers.

Table listing sections I through IX, including Astronomy, Botany, Chemistry, Engineering, Miscellaneous, Naval Engineering, Physiology and Hygiene, Photography, and Technology, with page numbers.

THE SIEMENS REGENERATIVE FURNACE PATENT IN THE SUPREME COURT.

A suit was brought by the Siemens Brothers against William Sellers and others, of Philadelphia, for infringement of this famous patent. The defense hinged upon the limitation of the American patent by the lapse of a period of seventeen years since the date of an English patent of prior granting.

Now that the Supreme Court has disposed of this and the driven well suit, the ground is clear for the rendering of their opinion in the great telephone suits. It is now eagerly watched for, and is expected every Monday.

THE DRIVEN WELL PATENT INVALID.

Some months ago, the United States Supreme Court rendered a decision in one of the famous driven well suits, in which the reissued patent granted to Nelson W. Green was declared a good and valid patent.

The decision, which was rendered on the 14th inst., is based on the record in a case, Nelson W. Green et al. against George Honey, which was originally brought in the Southern District of Iowa.

ROADSIDE PLANTING.

The subject of securing shade for roads by planting trees at their sides has within a few years been receiving considerable attention in Europe. In Belgium especially the work has been taken up with much interest, and the economic results ascertained.

At the Manchester meeting, in the present year, of the British Association for the Advancement of Science, the subject of forestry was discussed, and tree culture was strongly recommended to the English farmers.

Transfers for Zinc Etching.

A new method of preparing transfers for the zinc etching process has lately been introduced by Jaffe and Albert, of Vienna. With the usual method of making transfers in greasy ink, it happens sometimes, in transferring the developed greasy image to the zinc plate, that the lines or dots of the image will be crushed and become broader.

der consisting of a mixture of asphaltum, colophony, and wax, then the whites of the paper are freed from any adhering powder with the aid of a pad of cotton, and an alum solution is applied, in order to tan the gelatine on the paper, so that it may become hard, and not give way afterward in the transferring process.

Professor Tyndall on Lightning Conductors.

Prof. Tyndall, writing to the London Times, says: "Your recent remarks on thunderstorms and their effects induce me to submit to you the following facts and considerations. Some years ago a rock lighthouse on the coast of Ireland was struck and damaged by lightning. An engineer was sent down to report on the occurrence, and as I then held the honorable and responsible post of scientific adviser to the Trinity House and Board of Trade, the report was submitted to me.

The Peppermint Crop Abundant.

Wayne County, N. Y., is noted for its great growth of peppermint, and this year the crop is very large, it being estimated by a correspondent of the Graphic that it will yield over 200,000 pounds of oil.

The harvest begins usually in the last of August. The plant is cut, like clover, with a cradle, raked into cocks, when it is allowed to wilt a little before it is taken to the distillery. The process in distillation continues until the last of October.

SOUTH OF ENGLAND TELEPHONE COMPANY.—The directors of this company have declared a dividend of 6 per cent per annum on the preference shares for the half year ended 31st October.

**NEW THERMOMETER SCALE.**

BY J. ASHER.

I have recently devised a new scale for the thermometer. I divide the space between the absolute zero (-459.4° Fah.) and the freezing point of water into 1,000 degrees. The advantages which it presents are:

1. It has no minus degrees, and not a conventional, but an absolute zero. Hence no ambiguity can occur.
2. It will be very convenient in reducing the measurement of gases to the standard temperature, which is the freezing point. The temperature of a gas will be so many thousandths of the volume it would occupy at the freezing point of water. A gas in the new scale expands 0.001 of its volume, measured at the freezing point, for each degree of increase in temperature.
3. The degrees are smaller than those of other scales. Hence greater accuracy may be had when we use whole numbers only. Each degree is almost exactly half a degree Fah., the ratio being as 30 to 61.
4. A thousand, a round number, expresses the whole range of temperature, in the solid state, of water, the most useful substance.
5. The two principal points are absolutely fixed. The boiling point is objectionable in this regard, for it varies with the atmospheric pressure.

Here are some temperatures in what I propose to call the milligrade scale:

M.	
1366°	..... Water boils.
1298°	..... Alcohol boils.
1134°	..... Blood heat.
1000°	..... Water freezes.
853°	..... Mercury freezes.
0°	..... Absolute zero.

For common use the scale would not extend below 853°.

Strathroy, Ontario, Canada, November 11, 1887.

[FROM THE GARDENERS' CHRONICLE, OCT. 22, 1887.]

**The Problem of the Hop Plant Louse Fully Solved.**

Will you permit me to announce through your columns a discovery of no small importance to the hop growers of England and of the world? It is known in America that I have for some time been making investigations on the habits of the hop plant louse (*Phorodon humuli*, Schrank), especially with a view of solving the mystery attaching to its winter existence. A resume of the results up to the middle of last August was made public at the late meetings of the American Association for the Advancement of Science, and also of the British Association, and has already appeared in abstract in your columns, September 17 last, p. 333. That abstract gave the ascertained facts and predications up to the time I left America (August 17); and while one of my most trusted observers has been following the closing phases of the annual life cycle of the species there, I have been doing the same here in Surrey and Kent, and particularly on Mr. Charles Whitehead's place near Maidstone, where all the conditions were favorable. Although I have not yet received the final results from America, I feel quite convinced that they will prove similar to those obtained here, which may be summed up (omitting much interesting detail) as follows:

During the hop harvest (this year in Kent at its height the last week of September), and some time prior thereto, the insects are fast getting wings. This is the only winged generation produced on the hop, and all individuals, irrespective of brood, show the tendency to become winged, so thoroughly is aphid life, like plant life, influenced by temperature and season. The first to get wings are agamic females, and they instinctively leave the hop yards and settle upon different varieties and species of *Prunus* and begin at once to breed and bring forth young. Their flight is much influenced by meteorological conditions, but they swarm in the air during mild and pleasant days. On my very first visit to Maidstone, several settled on my person while I was being driven from the station, and where wind and temperature were favorable I have known them, in a single day, literally to cover certain sheltered damson trees close to a hop yard, where but few could be detected on such trees the previous day. They array themselves on the under side of the leaves, heads generally all in one direction, and in a very few days they are intersprinkled with their pale and wingless young, though each produces but four to five before dying.

These wingless individuals are the only generation produced in autumn on *Prunus*, and are the true sexual females. White at first, they become yellowish-orange and olivaceous with maturity, the head and the members darkening. The last to acquire wings in the hop yards are males, and they settle upon the plum leaves (this year most numerous October 5), and fecundate the females, which thereafter lay a few eggs (not more than four or five) around the latent buds, and in any crack or sheltered part of the twigs, especially of the previous year's growth. The eggs, at first yellowish-green, soon get darker, and finally black, and become, in time, more or less covered with dust particles, mould, the exuviae of mites, etc., which adhere by means of the sticky "honeydew" everywhere produced by aphides.

The winged males are easily distinguished from the

winged females by their smaller size and greater unrest, and when the former are most abundant the latter have disappeared. At the present writing the males are fast dying, and drying up, but the impregnated females still survive, though there have been snow and several white frosts. Some of the later born will doubtless live on till the leaves have fallen; but all will perish with the first severe frost, and the species will be perpetuated through the winter egg, as already set forth. The first eggs were observed on the 8th of this month. My observations show that the winged emigrants from the hop, while preferring the damson, feed and breed on all other varieties of *Prunus* which I have had an opportunity of examining, and which include the Bullace (a yellow plum), the Victoria (large red), the Black Diamond (large black), the Yellow Gage, the Green Gage, and the Orleans. Trees examined in counties where no hops are grown reveal only the plum aphid (*Aphis pruni*). This species, which remains on the plums the whole year, also occurs in late autumn in the agamic winged female, the winged male, and the wingless sexual female forms; and though often mixed with the hop Phorodon, is easily recognized by the want of cornicles, and by the greener color, darker members, and black eyes of the true female, which oviposits in similar situations as the Phorodon, and whose eggs are scarcely distinguishable from those of that species.

The absence of Phorodon multiplication on the hop, and the manner in which stray plants in field or hedge-row are forsaken, while what I have described is going on upon plum, is as marked as the freedom of plum in early summer after the winged migration therefrom to the hop.

The observations here recorded have shown (as such minute observations always do) the unreliability of inexpert testimony. As in America, this has been a year of exceptional freedom from hop lice in England, and when I first visited the hop yards at the commencement of the gathering, I was told very generally by laborers and owners that no lice had been noticed lately, whether on the hop or on the damson, and that I should find none. Yet, though the leaves of the hop were remarkably free, I had no difficulty in finding the lice in the burrs, or crawling in all conditions through the loose texture of the sacks being filled by the pickers, while the first deposited on plums were detected on the very first tree examined.

In conclusion, I have been struck with the great similarity in the general aspect of things both on the hop and the plum here and in America. Everywhere parasites and predaceous enemies of the lice belonging to the same or similar genera, and in some instances the same species, and everywhere the omnipresent red spider (*Tetranychus telarius*), and its equally omnipresent circular red eggs at this season! And while the lower average summer temperature will cause fewer generations of the Phorodon to be produced in England (probably only six or seven) than in America (where thirteen have been traced this year), and the beginning and ending of the insect's activity will be more abrupt there than here, yet in all essential points the life history of the species in the two countries is the same.—C. V. Riley, Tunbridge Wells, October 10, 1887.

**How to Plant Deciduous Trees.**

On the transplanting of trees, a writer in the *Garden* (London) gives the following advice, which is both practical and timely, and as applicable to this country as in England.

The best time for planting trees and shrubs is when they are dormant, that is, after they have made their season's growth and before they have begun to start afresh. Deciduous trees speak for themselves; when their leaves have fallen they may be said to be at rest, and they should be transplanted before the buds have begun to swell. Not that there is much mischief in a little delay, but the proper time is before the buds have become excited. The next point is to take up the tree with every fiber, if possible, undamaged, and more care is required to do this than many think proper to bestow upon it. I have seen valuable trees literally torn up by the roots in some nurseries because men would not take the trouble to lift them properly. How, therefore, can such trees be expected to thrive for at least a season or two after removal? Again, if the roots are mutilated, the head of the tree must be reduced in proportion. Moreover, in planting, the earth must be made to fill up all the interstices between the roots—there must be no hollow places; and, when a tree has been much mutilated, it is a good plan to puddle or, at least, make the pit in which the tree is to be put a kind of mud hole, that is, pour into it two or three pailfuls of water, and throw in a cone of loose earth, on which the tree should be placed, spreading out the roots well and filling up all round with loose soil. By moving the tree sideways, backward and forward, lifting it now and then a little, and continuing to fill in with earth, it may be made a fixture at a proper height, and a little patience will enable you to hold it moderately firm until stakes can be put in to support it and the soil settles. This kind of

treatment is unnecessary when the trees are small and carefully lifted, as they should be.

I prefer dry planting when the soil is in good order and finely broken; the soil can then be got in among the roots well enough to answer the purpose. In that case the point of most importance is to take the plants up well. Dig round them in a circle, as far off the stem as the ends extend, and release the latter carefully, so as not to break them; then, with a sharp knife, cut off the tap root close to the stem, and all ends that may happen to have got accidentally bruised, and, having roughly estimated the quantity of roots lost or injured, make amends by reducing the head in proportion. Cut out all weak shoots close to the stem, and remove any that grow upward or cross each other in the center, retaining only the best branches in the best positions, and, if any of them be too long, shorten them. Then, having made a pit large enough to hold all the roots, fill in with some soft, well-worked soil, and press the roots into position without bruising them. Hold the tree upright while the hole is being filled in, and shake it, in order that the soil may get well worked in between the roots. When the tree is properly placed, fill up the rest of the hole, and tread it well in, not by pressing the soil close to the stem, but by treading on it all round where the points of the roots are. When pretty firm drive in three stakes, in a sloping direction, so as to meet at the stem, and to these fasten the tree, so as to prevent wind waving.

A much neater way, however, of fastening trees is to drive three posts into the ground, in the form of a triangle, and nail some slabs to them. I have moved cedars 35 feet high, and fastened them quite securely in this way, the posts being driven into the ground 6 feet deep. But though deciduous trees show us so well when they are at rest, that period is not so apparent in the case of evergreens. It needs close observation to ascertain when they are at rest. With some it is at midsummer, with others later; but the cause of so many failures in transplanting evergreens is moving them when they are in active growth. If the foliage has attained its full size and proper color, and if the last growth made has assumed the same color as the rest of the trees, transplanting may be done with safety. If the ground where the trees are to be planted is dry, it must be well watered; and even the branches must be sprinkled if the weather is warm. Plants taken out of peat form an exception, for it frequently happens that a ball of earth, larger than the entire root space, lifts with them, and they are thus unaffected by removal. They do not, indeed, lose a fiber.

To recapitulate, planting successfully consists, first, in removing the plant from the place in which it grows without disturbing its roots much; secondly, if any roots have been lost, cut in the head so as to lessen the work which the roots that remain have to do; thirdly, in placing the tree again in the ground where it is to stand, solidly, and with the roots as nearly as possible in the position in which they were before removal; and lastly, in supplying moisture, if it be deficient, and in so fastening the tree in its place that it shall not afterward be injured by wind waving.

E. B.

**Brick Clay.**

The following analysis of blue clay from Farmington, Maine, was made by Mr. W. V. Wentworth, and may be of interest for reference:

SiO <sub>2</sub> .....	63.69
Al <sub>2</sub> O <sub>3</sub> .....	17.02
FeO and Fe <sub>2</sub> O <sub>3</sub> (mostly FeO).....	10.18
CaO.....	0.97
Na <sub>2</sub> O.....	4.02
H <sub>2</sub> O.....	4.05
	99.93

An approximate mechanical analysis gave the following results:

Coarse sand.....	3.73 per cent.
Fine sand.....	22.97 " "
Fine clay.....	69.25 " "
Water.....	4.05 " "
	100.00 per cent.

The sand was mostly feldspar, with traces of quartz and mica. The clay is used for brick making.—*Amer. Jour. Science.*

**An Improved Earth Plate.**

Professor Dorn, in the *Electrotech. Zeits.* for October, proposes a form of earth plate which should be valuable to all observers of earth currents, if, as is claimed for it, it reduces polarization to a minimum. It consists of a flat open box, made of wood or cement, and coated inside with asphalt. This is placed at the bottom of a hole in the ground. An amalgamated zinc plate lies flat in the box, and an insulated wire leads from it to the surface. Care must, of course, be taken that the joint is well covered, so that nothing but zinc is in contact with soil. An earthenware pipe stands on the zinc and rises to the surface. The box is then tightly rammed with clay, soaked with concentrated zinc sulphate solution, and the hole filled up. Solid sulphate is dropped down the tube and solution poured after it. A little fresh sulphate from time to time will keep the plate in order.

**A New Rock Breaker and Dredge.**

A solution of the difficult question of widening and deepening the Suez Canal, at the Suez end, appears to have been provided by Messrs. Lobnitz & Co. in a large marine dredger launched from their yard at Renfrew on October 6. This vessel, which is named the Derocheuse, is intended to inaugurate a new and simple method of excavating subaqueous rocks. She is very powerful and strongly built, and embodies a novel principle in rock breaking, invented by Mr. H. C. Lobnitz. Instead of using the ordinary system of boring holes in the rock under water, and breaking up the rock by means of explosives, the work is done by means of heavy blows with long chisel-shaped cutters. These cutters weigh each about four tons, and, when dropped upon the rock, they break it up, and dislodge it ready for removal by dredging. This has been demonstrated by various dry land trials with these cutters on some of the hardest rocks to be met with in Scotland. The cost of excavating and removing rock by the blasting system, when working at, say, 30 feet under water, may be stated at 20s. per cubic yard. With the new system, of which the Derocheuse is the pioneer representative, 4s. per cubic yard will easily cover the cost of breaking the rock and raising and carrying away the debris.

Various trials, which were carried out from March to June of this year at Craigmillar Quarry, Edinburgh, under the personal supervision of engineers from the Suez and Panama Canal companies, and Scotch and French engineers, have given most satisfactory results. At the last of these experimental trials the results showed an average of over 6 cubic feet of rock dislodged for each blow of a cutter weighing less than two tons. Similar results were attained at the other trials. The lowest average result was about 4 cubic feet per blow of this light cutter.

The dimensions of the Derocheuse are: Length, 180 feet; breadth, 40 feet; depth, 12 feet; and she is divided into eighteen water-tight compartments. She has machinery on board of a total indicated power of 1,000 horses, including hydraulic engines and rams for working the ten rock cutters, which are each 45 feet in length. For these, ten 6 ton hydraulic hoists are provided, capable of lifting to a height of 60 feet, and working with a pressure of 1,000 pounds per square inch. By means of a set of levers, one man can maneuver the whole rock-breaking apparatus without moving from his post, everything being self-acting and simple.

The rock, when broken and dislodged, is immediately lifted by a powerful dredging apparatus, the buckets of which work between the rows of cutters. This dredging machine is fitted with Lobnitz's guide wheel and pitch wheel driving gear, and is specially designed for the present purpose. It is capable of dredging from a depth of 10 feet down to a depth of 40 feet below the surface of the water, and will dredge ordinary material with ease and economy, and will also remove rocks of the most refractory nature.

On deck the Derocheuse is fitted with various powerful winches and cranes. There is special hydraulic gear on deck for maneuvering two steel pivots, which enable the vessel, when at work, to adopt a very neat system of covering the ground by a series of concentric curves. Thus the work never stops for the purpose of maneuvering, and every portion of the ground can be properly dealt with, leaving a level surface. In short, nothing that could tend to make the vessel efficient for her purpose has been omitted; and comfortable accommodation is provided in the vessel for the civil engineers, officers, and crew who will work her. Having twin screws, driven by two pairs of independent compound engines, solely used for propulsion, the Derocheuse will steam out to her destination, where she will immediately set to work upon the rocky part of the bed of the Suez Canal, where there are about three million tons of very hard rock to be removed.

During the last six years Messrs. Lobnitz & Co. have built for the Suez, Panama, and other works more than 26,000 tons of dredgers, floating cranes, hopper barges, and tugs, with over 20,000 indicated horse power of machinery.—*Iron*.

**THE "ROBINSON" VICTORIA HANSOM.**

The popularity of the Hansom cab, patented in 1834 by Mr. Joseph Hansom, is attested by the fact that there are now some 10,000 in use in the city of London. Hitherto they have been distinctively a closed vehicle. By a recent improvement, which we here illustrate, this feature is disposed of. The "Robinson" Victoria cab provides at will a perfectly closed Hansom, undistinguishable from the ordinary one, or an open carriage, adapted for full enjoyment of the pleasure of a drive in fair weather.

Besides this feature of opening or closing, other im-



THE ROBINSON VICTORIA CAB—OPEN.

provements are introduced. Thus the wheels have heavy rubber tires, similar to those of bicycles, so that a quietness of motion is by this feature alone insured to a considerable extent. The sash frames are metallic, and move in rubber-cushioned grooves, so that whether open or shut they cannot rattle.

The cab can be opened or closed by the driver in three seconds, while the horse is on the full trot. No intervention of the passenger is required. A sudden shower does not bring about a delay for putting up side curtains or adjusting other fixtures.

To close it, the two parts of the roof and the back are moved by one hand, without any noise, smoothly into their place. The action of the foot upon a pedal almost simultaneously raises the two side sashes, and the interior is completely inclosed. The reverse series of operations effects the opening. A slight pressure upon the foot pedal drops the side windows. A stud upon the roof is pressed, which releases the catch. The rear half

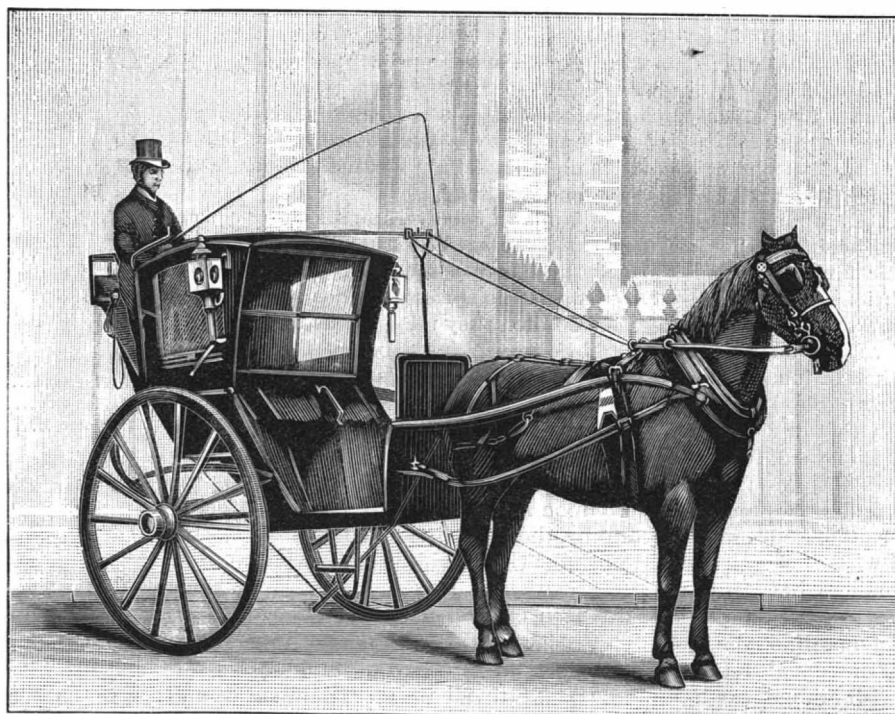

THE ROBINSON VICTORIA CAB—CLOSED.

of the roof and the back drop down. Reaching forward, the front half is pulled back, when it folds into place like an ordinary buggy top.

Our illustrations show the cab both open and shut. The general system of construction is also clear from them. It is needless to insist on how great an improvement this brings about. The transport by cab will assume a new aspect when the occupant can effect the journey in an open vehicle, with the knowledge that on a sudden shower of rain it can be instantly closed.

The inventor, Mr. J. C. Robinson, of London, whose present address is 140 Nassau Street, New York, has been interested in various street railroad enterprises in Europe, and having just completed the successful organization of a similar company in London, is now here to effect the introduction of this vehicle in our streets. After a personal trial of it we wish him every success, believing it to be a decided advance upon the ordinary Hansom and the coupe.

**Progress of Triple Expansion.**

The Drummond Castle, the second of the Castle line of Royal Mail steamers which has been tripled by Messrs. T. Richardson & Sons, of the Hartlepool engine works, lately left Hartlepool for a full speed trial of her new machinery. The original engines were built by Messrs. John Elder & Co., in 1881, and were of the two-crank compound type, having cylinders 51 inches and 88 inches in diameter, with a stroke of 4 feet 9 inches. These have been converted into three-crank triple expansion, with cylinders 33 inches, 55 inches, and 88 inches, steam being generated in three very large double-ended boilers, at a pressure of 150 pounds. During the twelve hours' trial the engines worked most satisfactorily, after which the ship was taken over by the representatives of the Castle Company, and left for London, where she arrived in due time, having made a very successful passage.

Besides the alterations to the main engines, a large refrigerator has been fitted, by means of which the passengers will be supplied with fresh meat, fish, milk, etc., throughout the voyage. All the cabins which were damaged by fire in London have also been renewed by Messrs. Withey & Co., of the Middleton Shipyard, and the whole of this work was accomplished in the short space of fourteen weeks. Messrs. Richardson & Sons have been advised by the Currie Company that the saving of fuel on the Grantully Castle, as compared with the old engines and boilers, has been 34 per cent on the voyage from London to Cape Town, and this great success has resulted in a decision to place their finest steamer, the Roslyn Castle, in Messrs. Richardsons' hands to triple, and she will arrive in Hartlepool early next year. This great saving in fuel has also been accomplished in the Union Company's steamship Trojan, which has just returned from her third Cape voyage. It is an interesting fact that the Drummond Castle's engines complete the large total of 30,000 indicated horse power manufactured by Messrs. Richardson & Sons since last January.—*The Engineer*.

**Carpet Moths and Beetles.**

A correspondent, in a seemingly discouraged mood, writes to the *Carpet Trade and Review* saying that carpet moths are playing sad havoc in Detroit, Lansing, and other cities at the West. Ordinary poisons seem to make them fat, and he appeals to the editor to suggest some remedy, adding that it would be hailed with pleasure by the sufferers and the trade generally.

The editor, after reminding the correspondent that he has already published several articles on the habits of carpet moths and beetles, adds that among the most effective remedies are kerosene oil and corrosive sublimate. Wads of cotton saturated with kerosene oil and placed in the cracks between the boards of floors are said to be efficacious against moths and carpet beetles. Corrosive sublimate is, perhaps, a still better remedy. Dissolve in an open jar one tablespoonful of corrosive sublimate in two quarts of boiling water, and after allowing the solution to remain undisturbed a few hours, apply it to both sides of the carpet or rug, using for the purpose a small whisk brush. It is not necessary to use more of the solution than enough to slightly dampen the surface of the fabric. As the solution is poisonous, it should be plainly labeled. In the case of carpet beetles, it is sometimes necessary to reduce the quantity of water in the solution, using but one quart instead of two.

The Carriage Builders' National Association, at their last meeting, passed a resolution approving of the adoption of 4 feet 8 inches, measured from outside to outside of tire on ground, as the standard track for carriages in the United States.

**AN IMPROVED CLOTHES RACK.**

A convenient attachment to bedsteads, walls, and other supports, which can be easily swung out for use and as readily folded back out of the way, and which will be firmly held as a means for hanging up clothes, is shown in the accompanying illustration, and has been patented by Mr. Francis W. Weis, of Louisa, Lawrence County, Ky. A metal disk is fastened by screws to the head frame of a bed or other support, and on a concentric annular ridge of this fixed disk is mounted to turn an outer disk, being held in place by a screw pivot passed centrally through both disks into the frame. Lugs limit the rotation of the movable disk, and in an eye projecting from its periphery is pivoted the forked end of a rack, adapting the rack to turn over with the movable disk and fold against the outer face of the same, as shown in the sectional view. The outer end of the rack is also forked to embrace loosely an eye pivoted thereto and projecting centrally from the inner face of a double-bowed spreader, from

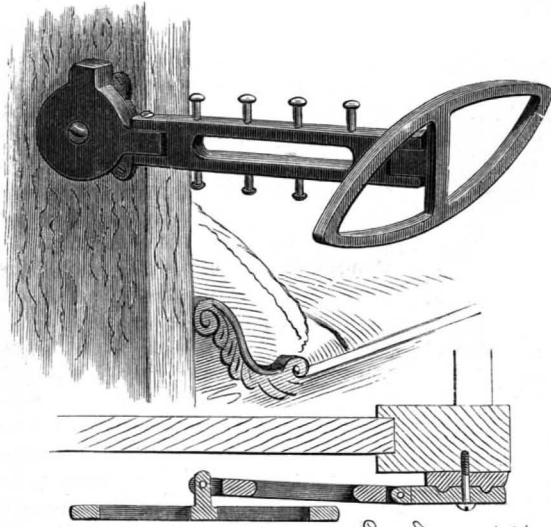

WEIS' CLOTHES RACK ATTACHMENT.

which coats, jackets, etc., may be hung without wrinkling, the spreader being also adapted to fold against the rack when the latter is folded back out of the way.

**AN IMPROVED HAY COCKING MACHINE.**

A machine adapted for gathering hay or other fodder crop from a field, and discharging it on the ground in compact piles, for protection against storm, is illustrated herewith, and has been patented by Messrs. Thomas and Henry Hale and Sylvanus D. Harvey, of Wales, Erie County, N. Y. To the main frame there is held a box which receives the hay from the elevator and distributor, the distributor working back and forth over the open top of the box, while the elevator takes up the hay from a rake which lifts it from the ground as the machine is drawn along. The rake is composed of a series of tines fixed to a transverse shaft, and controlled by a lever within easy reach of the driver, the movement of the lever backward bringing the out-turned lower points of the tines close to the ground to lift the scattered hay or other crop against the back of an inclined slide. As the hay rises upon the tines it is

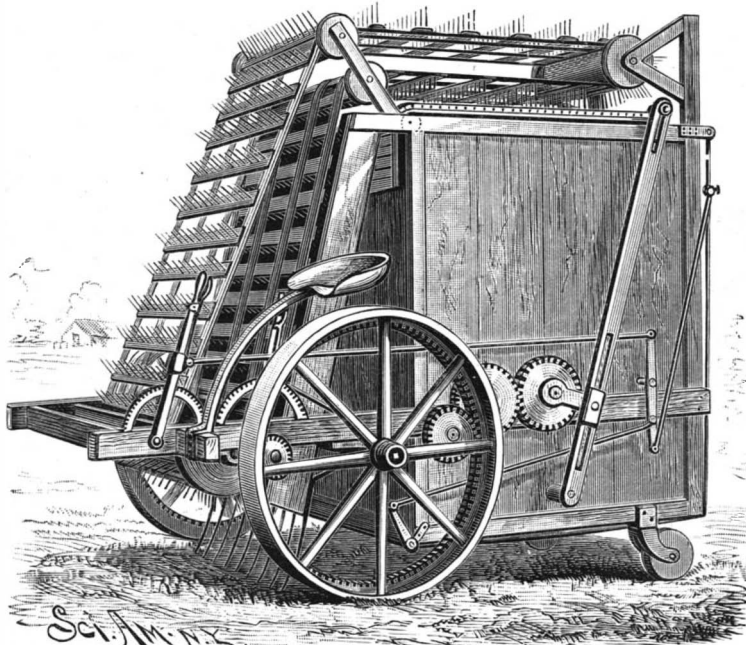

HAY COCKING MACHINE OF T. & H. HALE AND S. D. HARVEY.

caught by an elevator composed of a series of slats having pins fixed therein, and attached to suitable flexible webbing or bands, making an elevator belt which runs easily over pulleys journaled in bearings on the main frame, to carry the hay up from the tines, against the inclined slide, and deposit it on a distributor working over the top of the box. The distributor is composed of a series of slats fixed to a flexible web-

bing, which moves freely over and hangs from a roller journaled across the upper forward corner of the box, the slats resting upon cleats fixed to the sides of the box, guide rods preventing buckling and insuring the travel of the distributor belt in true horizontal plane backward and forward over the open top of the receiving box.

The distributor is operated by slotted bars pivoted at each side of the box, a block with a wrist pin sliding in the slot being connected with a crank arm on the shaft of a gear wheel operated by the main driving wheels, to swing the bars forward and backward with the advance of the machine, thus laying the hay evenly in the receiving box. The bottom or floor of the box is composed of a series of rods or tines fixed to a cross bar, to one end of which is attached a crank arm connected with a rod, the back end of which is pivoted to a lever fulcrumed to the side bar of the frame. The back of the box is also composed of a series of tines fixed to a cross bar journaled to lugs at the rear upper corners of the box, and to an outer tine there is fastened a rod, the other end of which is pivoted to the lever fulcrumed at the side of the frame. This lever is connected to the back end of a pull rod, attached at its forward end to a hand lever in reach of the driver. By pulling back this hand lever to the position shown in the illustration, the floor and back of the box are closed to receive the hay, but when the box is filled the driver pushes the lever forward, and thus lowers the box bottom and raises its back to quickly discharge the hay or fodder as the box is drawn along, leaving the crop thus gathered in a perfect cock well calculated to protect it from storm.

**AN IMPROVED TRUNK HANDLE.**

A handle for trunks, chests, etc., which has a spring to keep the loop or hand piece pressed down against the side, that it may not be accidentally broken when the trunk is tipped on end, has been patented by Mr. James W. Doty, of Pittsfield, Mass., and is shown in the accompanying illustration, the figures representing a front and a rear view of the improved handle. The plate which carries the swinging hand piece of the handle is made with a cross concave in its back, and is cast with partitions across this section, on one of which is a stud; the partitions being perforated to form bearings for a spindle, and the stud forming a catch for an intermediate portion of a spiral spring to engage with. The spring is connected at its center with the plate, and at its ends with the spindle, giving a steady and uniform action on the spindle, and providing for the easy and quick fitting of the parts together. With this construction the loop piece is readily raised, but, as soon as released, springs back to its normal position against the side of the chest or article.

**Salt a Factor in Building.**

The *American Architect* asserts that one of the new building materials which is likely to be found useful in many ways is common salt. Among the carpenters salt is now found to be useful as an aid to the heating of glue. Where, as is usual in joiners' and cabinet makers' shops, the glue is melted in a jacket kettle, surrounded by water, it is said to be advisable to put salt in the water in the outer kettle. The addition of salt raises the boiling point, and, therefore, allows the glue in the kettle to be kept at a higher temperature than could be maintained with water alone, and this is advantageous to the work. The masons find their use for salt in adding it to cement mortar in cold weather, to preserve it from the bad effects of freezing. It is not quite clear why the salt should act in this way, as the beneficial results of using it are visible with mortar which

has certainly been frozen, and frozen salt water expands nearly as much as fresh water. But engineers and contractors who have tried it are unanimous in their opinion of its value. In many cases masonry has been laid in cement in cold weather, using a considerable proportion of salt in the mixture, which, after repeated freezings and thawings, has remained in perfect condition, while work near by laid in mortar of the same

kind, but without salt, has been disintegrated by the frost.

**AN IMPROVED CULTIVATOR.**

A cultivator which is designed to cut up and pulverize a good deal of ground is shown in the accompanying illustration, and has been patented by Mr. Thomas G. Tasker, of Onslow, Iowa. The cultivator head bar,

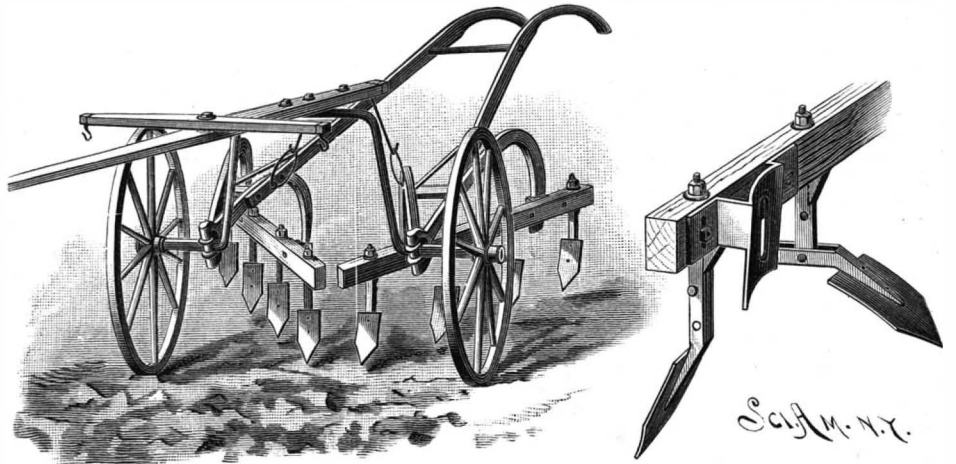

TASKER'S CULTIVATOR.

to which the plow points are attached, may be of wood or metal, and the bar is attached to the ends of the beams by bolts, which, instead of being passed through the bar in the usual manner, pass through the beams and through angle plates secured to the rear surface of the bar. These angle plates are formed with a slotted diagonal breast piece, and slotted side plates, to permit the bar to be adjusted vertically at the points of connection to the beams, and to permit the plate to be adjusted vertically on the bar, as shown in detail in the small figure. The shanks of the plow points are pivoted upon strong pins, but are held at their upper ends by wooden pins, so that in case the plow point strikes a solid obstruction the strain will break the wooden pin and permit the point and point shank to turn on its strong pivotal pin, and thus obviate all danger of serious injury to the cultivator.

**A SAFETY ATTACHMENT FOR STEM WINDING WATCHES.**

A device whereby a watch may be safely wound up without danger of breaking the spring, the device being one which can be simply and quickly adjusted to accommodate any strength of spring, and which can be used in connection with any ordinary case, is

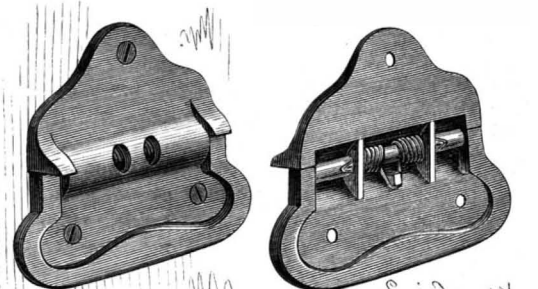

DOTY'S HANDLE FOR CHESTS, TRUNKS, ETC.

shown herewith, and has been patented by Mr. Willis S. Richardson. An exteriorly threaded sleeve is detachably secured in the under side of the usual crown, a lock nut being screwed upon the sleeve, and the stem, which projects upward into the sleeve, has a rectangular longitudinal recess adapted to take the movement. The upper end of the stem has a circular interiorly threaded aperture, and opposing longitudinal slots, a screw with tapering head fitting in this aperture, the screw being carried down into the shank a sufficient distance to expand the shank against the walls of the sleeve, so that a tension will be had equal or slightly more than equal to the strength of the spring adapted to be wound by the stem. When the crown is turned in the proper direction, the stem will be held sufficiently rigid in connection with the sleeve to wind the spring, but when the spring has been wound to the full limit, and more resistance is met with, the sleeve will turn upon the stem, thereby taking off any serious or damaging strain, which otherwise would be exerted directly upon the spring.

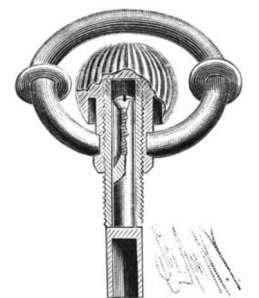

RICHARDSON'S WATCH PENDANT.

For further information relative to this invention, address Mr. Alex. Milne, No. 19 Ward Street, Newark, N. J.

**Modification of Habit in Ants.**

At a meeting of the Philadelphia Academy of Natural Sciences, Dr. Henry C. McCook described a raid of the Sanguine ants, *Formica sanguinea*, which occurred in a vacant lot at Asbury Park, N. J. The co-operative nest of the two species was established quite near the sidewalk, and the raid was directed thence into the open lot. The marching column of Sanguines was accompanied by a few individuals of the black slaves. What special purpose the latter had he was not able to determine. The eagerness exhibited by the Sanguines upon the march was very noticeable, although these creatures are always active in the nest and at any domestic labor as well as war, in which respect they differ largely from the shining slave makers, *Polyergus lucidus*.

On the occasion of which he spoke, the nest of Fuscous ants, *Formica fusca*, against which the expedition was directed, was concealed among a large amount of forest rubbish, such as bits of broken chips, twigs, dried leaves, etc., that were scattered over the barren space, interspersed here and there with tufts of grass and low huckleberry bushes. The invaders had evidently located the nest, but not with absolute accuracy, at least they were not able to determine the point at which it might successfully be assaulted. A most animated scene was presented over the entire surface, some three feet in diameter, upon which was concentrated the united energies of the warriors. Over and around this space in various lines the ants wandered, crossing and crisscrossing each other's pathways, sometimes singly, sometimes in couples or triplets, or in larger crowds, but always exhibiting an attitude of fevered eagerness, applying their mandibles and mouth parts continually to the ground in search of the point of vantage which would give them ingress to the coveted treasures of the Fuscous ants.

A space about ten inches in diameter, strewn with dry chippage, seemed to represent the locality beneath which the blacks had established their formicary. The Sanguines energetically pulled away the chips, scattered them here and there, burrowed lightly in the earth, hoping to obtain an opening. About two feet distant from this point the speaker discovered a small round entrance or gate, which was soon identified as one of the outer approaches to the Fuscous nest, for several of these ants were seen issuing from the gate and others were hovering around it. At this moment one of the Sanguine army, in the spirit of a pioneer or scout, approached this point. Thereupon the blacks climbed up adjacent spears of grass, where they remained apparently on guard. After about ten minutes spent in the exploration which has been described, the reds began to drain off from the center of search toward their home. In the meantime a considerable number of the Fuscous, who had evidently been out upon foraging expeditions and were homeward bound for the night, discovering the crowd of enemies who surrounded their borders, had discreetly taken refuge like their associates on the tufts of grass everywhere around the margin of the space within which the Sanguines had been operating.

Two of these blacks, more courageous or cunning than their associates, Dr. McCook observed to slip into a little opening and disappear inside. They were presently followed by several Sanguines, who, however, shortly returned from within and proceeded with their surface explorations, apparently having found no clew to the main formicary. The blacks, however, had certainly safely entered their home. He greatly wondered at this, and regarded it as an evidence of remarkable cunning and skill in strategy on the part of the Fuscous, which had enabled them thus so rapidly and easily to close the opening to their nest and throw the invaders off the scent.

An hour after the commencement of the raid not more than half a dozen of the Sanguines remained upon the scene, the rest of their company having abandoned the search for this time at least. This corporal's guard of persistent scouts also gave up the search at last and marched back home, the secretive skill of the blacks having thus far prevailed for the protection of their colony.

The interesting fact in the history of these curious creatures to which Dr. McCook wished to call especial attention is that their instinct for kidnapping has appeared to develop on the part of those who are the victims of it a corresponding strengthening of instinct in the way of concealment. The Fuscous ants are ready enough to defend their homes with their lives, and often do it successfully when their numbers are great enough to overcome the superior physical power and warlike skill of their enemies. But the weaker colonies of Fuscous must always yield to the prowess and strength of the Sanguines, unless their cunning can put their invaders at a disadvantage.

The case just mentioned does not stand alone. At various times when the speaker had observed these black ants in such site that they are exposed to the attacks of the Sanguines, he had noticed that their nests were constructed very differently from those of colonies in neighborhoods not infested by Sanguines. In the latter positions it is the habit of the Fuscous to raise

above the surface of the ground a flattened moundlet, or sometimes a mound of considerable size. Over the summit and at the base of these elevations are scattered the gates or openings into the galleries, without the least attempt at concealment. The whole formicary shows that its inmates dwell in security, without any fear of such special perils as those described. On the contrary, the Fuscous colonies established in the near vicinity of their hereditary foes have a marked tendency to omit or subdue elevations above the surface, the dumpage from interior galleries being apparently scattered broadcast instead of piled above the central formicary. Their gates are few and cunningly concealed, and quantities of rubbish are scattered around, with the evident intention of hiding the locality of their nest or making the approach to it more difficult. It has thus come about with these unfortunate blacks, as is the case with the human species, that the difficulties of life and perils to person, offspring, and home have developed a higher order of protective instinct.

A similar faculty Dr. McCook had observed in the case of an amber-colored ant, the Schauffuss ant, *Formica schauffussi*. He was watching the assault of a colony of Sanguines upon a Fuscous nest in the grounds of his friend Mrs. Mary Treat, Vineland, N. J., when he chanced to see a solitary individual Schauffuss moving back and forward a little distance from the scene of invasion. Knowing that this ant is sometimes enslaved by the Sanguines, he directed his attention upon her, and easily perceived that she was putting finishing touches upon the closure of a little hole that marked the gate of her formicary. A tiny pebble was placed, then a few pellets of soil were added. Next the worker walked away, took a few turns as though surveying the surroundings, and cautiously came back. The coast was clear. Now she deftly crawled into the small open space, and the observer could see from the movements inside, and occasional glimpses of the tip of her antennæ, that she was completing the work of concealment from the inside. At last her task was done and all was quiet. Just then a single Sanguine warrior, apparently a straggler from the invader's army near by, or some independent scout it may be, approached the spot. It walked around the nest, which was indistinguishable from the surrounding surface; sounded or felt here and there with its antennæ; passed over the very door into which the Schauffuss ant had disappeared, and although its suspicions were evidently strongly awakened, it at last moved away. The speaker felt satisfaction that the Sanguine depredator had thus been baffled and that the instinct of home protection had proved too much for the wretched kidnapping cunning. However, his pleasure was somewhat clouded by the reflection that the slave-making scout would probably be back before long, accompanied by the host of its fellows, and do its work more surely. But the impression remained strong upon his mind that the Schauffuss colonists, like the Fuscous ones above alluded to, had decidedly modified their habits of nest architecture to meet the perils arising from close neighborhood to their kidnapping enemies.

**Aluminum Bronze for Great Guns.**

Mr. Alfred H. Cowles, who has succeeded in manufacturing aluminum for commerce by electricity, lectured before the Naval Institute, at Annapolis, October 27, upon the use of aluminum bronze for heavy guns. The lecturer claimed that of this material guns could be made at twenty per cent less cost than built-up guns of steel, affording an ordnance of equal efficiency and far less difficult to manufacture, while the metal itself, which would represent sixty-eight per cent of the cost of the gun, could be remelted and used over any number of times without alteration of its composition. After describing the manufacture of a so-called bronze steel gun in Austria, made with 92 parts copper and 8 parts tin, conical steel mandrels being successively driven through the bore to give increased strength, hardness, and greater elastic extension, the lecturer said that, with the use of aluminum bronze, "we would start in the original casting with the following properties: Tensile strength, 70,000 pounds to the square inch; elastic limit, 23,000 pounds to the square inch; elastic extension, 0.0018 per unit length; reduction of area, 30 per cent; ultimate elongation, 40 per cent; hardness, about 13. By mandreling, the strength of this metal in the bore could be increased to over one hundred thousand pounds to the square inch, and the elastic limit raised to sixty or seventy thousand pounds.

"The stretch within the elastic limit would be increased, and, as other tests than those given show, would far surpass that of gun steel. The outer portion of the walls, where the strain is not as great at the moment of explosion, would have a great reserve of ductility. It would be impossible to burst such a gun with four times the powder pressure now used in the steel built-up gun. The walls would be solid. There would be no danger of crystallization. No rust or verdigris can form on aluminum bronze. The finished gun would have the color and luster of gold. It would not be affected by salt water. The fabrication of such guns would not require a great outlay of capital invested in plant, and the mineral resources of our country are

capable of supplying in inexhaustible quantities the raw material necessary for the production of the aluminum alloys. Were our government enabled to make a great advance in the art of gun fabrication before equipping itself with the guns now needed, it would render valueless against us the present armament of Europe."

**An Extinct Volcano in Connecticut.**

The recent discovery of the remains of a volcano near Mount Lamentation, the highest peak in the chain of Meriden hills, has excited the keenest interest in scientific circles. It has furnished a new key to the geological history of the Connecticut valley. The discovery was made by Prof. W. N. Davis, of Harvard University. He has been engaged in making an exhaustive study of the trap rock of this State, and he made his happy discovery of volcanic ruin while searching for an entirely different class of geological phenomena.

Mount Lamentation has been visited by large numbers of people during the past few weeks. The various scientific associations of the State and several geologists of national repute have carefully examined the interesting curiosity. No volcanic cone or crater is still visible, but the phenomena of the place clearly indicate that in the Triassic age violent explosive eruptions of a regular volcanic type were frequent. Geologists have long known that the trap rock of the Connecticut valley came up in a molten condition and afterward solidified. This liquid mass sometimes solidified in fissures in the earth and sometimes overflowed the surface like lava streams, and was subsequently covered up by strata of sandstone.

Prof. Davis has discovered what is technically known as an ash bed. It is a deposit formed when molten lava is thrown high into the air by violent explosions and comes down in a confused mass, coarse and fine. In the Triassic period, when these eruptions occurred, there must have been regular cones and craters of the usual type, but these have all been effaced. It is very probable that other ash beds may exist in the range of Meriden hills. The geological history of this region has always afforded a rich field for scientific research, and the recent volcanic discovery has given a greater scientific boom to it.—*Boston Globe*.

**Meeting of the National Academy of Sciences.**

On November 8, the National Academy of Sciences met in this city, at Columbia College. The sessions were devoted to the reading of papers by the different members, while receptions by Prof. C. F. Chandler, by Mrs. Henry Draper, and by President and Mrs. Barnard were social features of the occasion. Among the papers read were the following: Prof. Mendenhall, in a paper on "Seismoscopes and Seismological Investigations," treated of the comparatively new science of earthquake phenomena. Prof. Cope spoke on "The Primary Specializations of the True Fishes," and later on "The Mechanical Structures of the Hard Parts of the Mammals," and President Barnard read a paper by Prof. Henry Mitchel on "The Circulation of the Sea through New York Harbor." In this essay the superiority of the harbor and its freedom from ice were dwelt on. Prof. William A. Rogers, of Colby University, Waterville, Me., spoke on "The Behavior of Metals under Variations of Temperature," and in connection therewith exhibited his comparator, an instrument that can measure lengths within the hundredth of a millimeter. Prof. E. C. Pickering spoke of some of the work done at the Harvard College Observatory recently illustrated in our columns. His title was the "Determination of Star Magnitudes by Photography." At another time he also spoke of the work in general of the Henry Draper memorial. Profs. T. Sterry Hunt, Ogden N. Rood, J. D. Dana, and Wolcott Gibbs were among those who contributed to the papers read. Among those present may be mentioned the following well-known scientists:

G. J. Brush, E. S. Dana, O. C. Marsh, and A. W. Wright, of Yale; C. A. Young, of Princeton; J. S. Newberry, W. P. Trowbridge, of Columbia; W. K. Brooks, of Johns Hopkins; G. H. Cook, of Rutgers; A. M. Mayer, of Stevens; A. S. Packard, of Brown; C. H. F. Peters, of Hamilton; Prof. Henry Morton, of Stevens Institute; S. H. Scudder, of Cambridge, Mass.; Cleveland Abbe, J. S. Billings, E. Coues, T. N. Gill, and Asaph Hall, of Washington, D. C.; G. F. Barker, of Philadelphia; Col. H. L. Abbot, New York City; James Hall, Albany; and Raphael Pumpelly, of Newport, R. I. The meeting ended on the afternoon of November 10.

**The Cigarette.**

The unusually large number of young men who have been committed to the State insane asylum of Michigan in the last year and a half has led to the discovery that almost all of them smoked cigarettes to excess. In many cases it is said to be absolutely certain that cigarette smoking was the cause of the insanity. It is also reported that a prominent society young man in Detroit has been made deaf by cigarette smoking.—*N. Y. Sun*.

## Correspondence.

## The Safety of the Eiffel Tower.

To the Editor of the Scientific American:

In reading your various notices of the building of the Eiffel iron tower in Paris, I have been unable to find any estimate of the probable oscillation which will be set up in the tower by intermittent gusts of wind. I have frequently noticed that where strong winds have passed over country covered with large trees, some of the trees were broken short off, while others standing close to them, with apparently a larger surface of head exposed to the wind and a smaller diameter of solid wood in the trunk, have remained uninjured.

Now, I think the only possible explanation of this is that the time of the oscillations of the trees that were broken off happened to correspond with the time of the intermittent gusts of wind, so as to increase the effect of the pressure enormously, while in those that remained uninjured the times of oscillation and wind pressures did not so correspond. If this theory be correct, with a tower so high as that which is building at Paris, and of such a material as iron, will not the time of the oscillations set up by intermittent gusts of a high wind be sure, sooner or later, to correspond with that of the wind gusts, and when this happens, no matter how firm the foundations or how strong the material of construction, will not the whole building inevitably collapse? With the gusts of wind so timed as to increase the oscillations of the tower, the weight of the structure would increase the danger instead of being an element of safety. W. E. ABBOTT.

Windsor, New South Wales, Australia.

[While our correspondent points out what is certainly an element of danger, it is one that exists for all structures. If smaller towers withstand it, the Eiffel tower presumably will be built of such strength and elasticity as to resist the rarely occurring synchronous blasts of air.—ED.]

## Mining Frozen Ground.

In speaking of the Yukon River country, the Alaska *Free Press* says: The ground there is covered to some depth with a thick matting of moss, which is impervious to the sun's rays, and, in consequence, when the ground underneath once becomes frozen it remains so. To obviate this very serious drawback, the miners have set fire to the moss, which in summer becomes as dry as tinder to a depth of several inches, and thus from the heat of the fire, and being uncovered and exposed to the sun and atmosphere, it is thought that in a short time a vast amount of now frozen gravel will be thawed out sufficient to wash. Should this be the case, there is room enough on Forty Mile Creek and its tributaries for 1,000 miners. There is no reason to doubt (and the boys from the Yukon do believe) that other creeks that put down from the Alaskan range in that neighborhood are equally as rich as Forty Mile Creek, but of course nothing whatever is known of them and will not be until explored. Alaska is a great, big country, and years will come and go before its resources are shown up. The trip to the Yukon is a long and difficult one, and three-fourths of the miner's time is consumed in going to and from the country. Provisions have always been scarce, and the miner has always had to rely upon his back and boat as a means of transporting them into the country. With the great difficulties experienced in getting into the interior, it is no wonder that it has not been shown up ere this. Alaska yearly pays into the treasury enough to more than defray the expenses of building roads into the interior, establishing ports of entry, and it is an unwise administration indeed that will keep piling up this money in the vaults at Washington when it would be of such great benefit to the whole Territory and the thousands of miners who contemplate going in and opening up a great section of country that has never felt the tread of the white man's foot.

## Why Men Fail.

Few men come up to their highest measure of success. Some fail through timidity, or lack of nerve. They are unwilling to take the risks incident to life, and fail through fear in venturing on ordinary duties. They lack pluck. Others fail through imprudence, lack of discretion, care or sound judgment. They overestimate the future, and build air castles, and venture beyond their depth, and fail and fall. Others, again, fail through lack of application and perseverance. They begin with good resolves, but soon get tired of that, and want a change, thinking they can do much better at something else. Thus they fritter life away, and succeed at nothing. Others waste time and money, and fail for want of economy. Many fail through ruinous habits; tobacco, whisky, and beer spoil them for business, drive their best customers from them, and scatter their prospects of success. Some fail for want of brains, education, and fitness for their calling; they lack a knowledge of human nature and of the motives that actuate men. They have not qualified themselves for their occupation by practical education.—*School Supplement.*

## On Toilet Soaps and Towels in Hotels and Other Public Places.

Despite the vast improvements in the management of American hotels, there are still many defects and drawbacks which, though they may seem of practical insignificance, are in reality of deep importance to the public. Chief among these may be mentioned the toilet soap furnished the patrons in their bed rooms and baths, and the temporary guests in the wash rooms. As a general rule, it may be said that no American hotel uses even decent soap. The writer has had a wide experience among the great establishments of New York, and in only two has found a toilet soap that was really of superior quality. Many proprietors purchase cheap Castile and poor cotton seed oil soap by the hundred bars, and cut these into convenient cakes. They cleanse well and generally are free from coarse perfumes and poisonous coloring matters. But nearly all brands of this class are poorly made and strongly alkaline. They not only attack the skin and eventually produce sores, but they also irritate the mouths of the pores and eat into the glands and the oil they contain. Their use gives a clean skin, but one that is dry, rough and inelastic. Frequently, after a few days, dried white patches rise and fall off, the lips and nostrils chap, and a general feeling of uneasiness and even positive discomfort results. Worse than these are the cheap and nasty toilet soaps so much in vogue. They are made from rancid vegetable oils and half-decomposed acid animal fats with impure alkalies, in the shortest time and the cheapest manner possible. To cover up their foulness or poor workmanship, the manufacturer colors them with brilliant dyes or very dark dyes, and with the rankest essential oils the market affords. A cake taken from a second-rate Broadway house is a good case in point. It has a neat oval form, a strong but pleasant odor, lathers freely, and is of a handsome rich brown hue. To any but an expert it would appear a superior article, while to a hotel proprietor it offers, besides all these attractive qualities, the far more fascinating element of extreme cheapness. Careful examination and analysis show that the brown color conceals a slovenly workmanship which would otherwise be exposed, in irregular masses of varying shade and consistency, and that the strong essential oils serve to smother a rank smell of putrefaction and nauseating raw materials. The amount of the oils is so large as to act as a rubefacient and even an irritant upon the skin. The writer once experimentally rubbed it on his face and allowed the thin saponaceous film to remain ten minutes before washing it off. On its disappearance he found the cuticle covered by numerous red points intermediate in appearance between acne and eczema, which lasted twenty-four hours before the face resumed its natural appearance. Such toilet soap applied to women of fine complexions, but of sensitive skins, would ruin their appearance in less than a fortnight, and would, in the long run, produce a condition of the cuticle which would require weeks of medical treatment to restore to its pristine state. Far worse would be its use upon babies and young children. Their skin is finer and more delicate than can be easily described. Irritated by such soaps, it would break out into painful eruptions, and in a short while thereafter into running sores.

The evils described apply chiefly to the bed room and bath room. Those of the public washroom are far worse. Here a larger cake is employed, and almost invariably one whose workmanship is so inferior that with the slightest use it becomes pulpy or sticky. In this condition it does all the harm mentioned, and besides this it may act, and frequently does act, as a vehicle for disease virus and disease germs. A person suffering from a skin complaint or from some blood disease which manifests itself in cutaneous disorders, ulcers, or other sores, uses the cake, and by the mere friction of rubbing, loosens scales and pieces of diseased matter which are retained by the glutinous surface of the soap. These may or may not contain the virus or the germs referred to. If they do, the next person who uses that cake runs a serious risk of absorbing the contagion and becoming a sufferer from the same disease. So bad are matters in this regard that the only safe rule for a person solicitous for his health is to never use the soaps supplied by hotels for patrons and guests, but to always carry his own with him, or to try a fresh cake, no matter how great the temptation may be to use that which is freely offered him in places of public resort.

More objectionable yet are the unwieldy roller towel, the saloon towels, and the long and broad towels of the wash room. These under any and all circumstances are a disgrace to the house that uses them and an insult to its customers. The towel removes moisture from the face and hands by rubbing. The friction does more, however, than remove moisture. It forces off scales, pieces of dead skin, lymph from cuts and abrasions, mucus from the nostrils, perspiration from the pores, pus from sores and ulcers, and anything liquid that may be excreted from the body or may have been thrown upon the surface. The fibrous and interlaced structure of the towel makes it a marvelous receptacle and catch-all for these varied substances. They remain

in its interstices until it is washed, and even long after, unless it is thoroughly boiled and rubbed with strong laundry soap or treated with javelle water or chloride of lime. It is all very well for the first man who applies a towel of the class mentioned to his face and hands. The second man runs the risk, and the risk increases arithmetically with each user. As nearly one man in fifty suffers from some contagious or germ disease, and as these hotel and saloon towels average 200 users a day, it is clear that every one toward the end of its daily career is in all probabilities a source of danger and disease. It is better to go with a dirty face and soiled hands than to use such apologies for decency. It is a thousand times better for proprietors to supply unlimited small linen or cotton napkins, which once used are consigned to the laundry, or the inexpensive Japanese paper cloths, which once employed are thrown away into the ash barrel.—*Amer. Analyst.*

## The Marriage of Flowers.

The flowers that bloom in the fall are now to be found at the fall exhibition of the New York Horticultural Society. Three long tables were covered with cut chrysanthemums of rare and radiant design and color.

To appreciate properly the exhibition, however, the services of John Thorpe will be necessary. John Thorpe is a somewhat tall and very valuable chrysanthemum whose trunk is of brown diagonal, with a calyx of brown beard under his chin and a corolla of shrewd and rugged features which light up with interest when he discusses his favorite pursuit. He is the secretary of the society, and lives at New Rochelle. When John Thorpe sits down in the shadow of a date palm, with two chrysanthemums about to be married in his hands, he becomes singularly interesting. Of the two chrysanthemums, the bride is arrayed in spotless white and the bridegroom in a brilliant vestment of red.

"The marriage of two flowers," says Mr. Thorpe, in a semi-poetic but entirely practical way, "is exactly like any other marriage. Most of the flowers on exhibition here are composite varieties, but in the simple varieties the male and female flowers are easily and instantly distinguished by a practical eye. The development of chrysanthemums is nothing more nor less than the breeding of them, and exactly like the breeding of fine varieties of stock. Five years ago we had nothing but simple flowers. Now you see the wonderful variety of shapes and sizes and colors which has resulted. This has come from hybridization, and that is done in this way."

Cutting off the long petals of one of the flowers, he showed at the base of each the pollen which had ripened and was ready to be scattered by the air in the shape of an impalpable powder. Cutting away the petals of the other, he brought to view a multitude of fine stamens, slightly sticky. Whenever the pollen powder touches any of these sticky points, a floral union takes place, and the flower grown from the resultant seed partakes of the characteristics of the two which went to form it.

"In growing the flowers," Mr. Thorpe continued, "we take a fine camel's hair brush, and with it transfer the pollen from one flower to the other. This process, in nature, is fulfilled by the air, by insects, and in various ways. There are some flowers which are fertilized only at night by moths. There are others which are wedded only in the day by the butterflies and the humming birds. When you think of moths and butterflies and humming birds reading marriage services over the flowers in a garden, there is quite an opportunity for poetry in flower culture. The arrangement is sometimes very wonderful," he said, taking a quaint and grotesque orchid in greens and browns. "This flower is self-generating, and the fertilization is carried on by the ants. The ant can get into this flower only by going over the pollen cells, and the pollen clings to him. He can get out only by passing over those places which the pollen needs to touch, and for the new flowers the ant alone is to be thanked. The same way of developing flowers can be applied to any variety. You could breed roses, for instance. The value of the chrysanthemum, however, is that you get your new results in a year, where, with roses, equally satisfactory results would require five years. The New York society has gone beyond the Japanese flowers. There is a stand of them, direct importations, over there. You can see, however, that in color, size, and design they do not compare, though it used to be said, and is still said, that the Japanese chrysanthemums beat the world. Yes. The flowers will be all the rage for a time now. The streets and the theaters will be full of them."—*New York Times.*

THE INTERMARRIAGE OF COUSINS.—The Legislature of Illinois has passed a law making the intermarriage of cousins a penal offense. This is an unwise law, first because it interferes unduly with personal rights, and next because it is not called for. The marriage of cousins who are each of healthy family and physique, and especially if they are of different temperaments, is quite free from danger.—*Med. Record.*

**Quicksilver Ores.**

Speaking on the character of quicksilver deposits, Prof. S. B. Christie, of the University of California, in his testimony in a recent case in San Francisco, said:

Quicksilver deposits, as a general rule, are very different from those of the ores of other metals. Many other metals occur in well-defined fissure veins, so that there is no difficulty in following the ore, and in many cases of calculating beforehand the amount of ore in sight; but with the exception of the deposit at the old Almaden in Spain, and to some extent the deposit at the Idria in Austria, the quicksilver deposits, particularly those of California, are characterized by a great and persistent irregularity, so that it makes the mining of those ores much more difficult than that of other metals. New Almaden is a striking example of this irregularity. It has often occurred in the history of the mine that there was none or scarcely any ore in sight, and it has often looked as though the mines must of necessity be shut down, and it has only been by the most careful and painstaking prospecting or dead work that it has been possible to keep up the production of the mine. Very frequently large bodies of ore will almost completely run out, and there will be visible in the fall of the works only a slight coloration in the vein matter, which indicates that there is ore left in that particular place, and by following out this little spring of ore carefully it may lead into a large deposit. As a result of this, the workings of the mine are necessarily very irregular, and it requires the greatest skill on the part of the engineer in charge of the works to keep up a regular and steady output of ore.

**IMPROVED CUTTER GRINDER.**

We illustrate a machine exhibited by Messrs. Hulse & Co., of Salford, at the Newcastle exhibition, and shown in *Engineering*. It is intended for grinding to a cutting edge the teeth of face or edge milling cutters up to 6 inches in diameter and 9 inches in length. Emery wheels are used for grinding the cutters, the face and not the edge being employed, so that wheels of a comparatively large diameter may be employed. Besides ordinary milling cutters, parallel or tapered reamers can be finished at this machine, which will also cut straight or spiral grooves. As will be seen on the engraving, besides the emery wheel for the special work, another for ordinary grinding purposes is attached to the machine, with an adjustable rest for carrying the work.

**Manna, the Heavenly Bread.**

Mr. Cole, of Bitlis, a missionary of the American Board, in Eastern Turkey, in describing a journey from Harpoot to Bitlis, says:

"We traveled for four days through a region where had newly fallen a remarkable deposit of heavenly bread, as the natives sometimes call it—manna. There were extensive forests of scrubby oaks, and most of the deposit was on the leaves. Thousands of the poor peasants, men, women, and children, were out upon the plains gathering the sweet substance. Some of them plunge into kettles of boiling water the newly cut branches of the oaks, which washes off the deposit until the water becomes so sweet as to remind the Yankee of a veritable sugaring off in the old Granite State as he takes sips of it. Other companies of natives may be seen vigorously beating with sticks the branches, that, from having been spread on the ground, have so dried that the glistening crystals fall readily upon the carpet spread to receive them. The crystals are separated from the pieces of leaves by a sieve, and then the manna is pressed into cakes for use. The manna is in great demand among these Oriental Christians. As we were traveling through a rather dry region, the article came in play for our plain repasts."

THE falling off in the catch of shad in the Connecticut River is very great every year. It is most marked, however, in the Thames River. Formerly the fishermen would sometimes take 2,000 shad at a haul. It has decreased in a few years, so that now the total catch reported for the last two years has been but 45 and 27 respectively.

**IRRADIATION.**

BY GEO. M. HOPKINS.

Brilliantly illuminated white surfaces and self-luminous bodies, when emitting white light, appear to the eye much larger than they really are. In nature examples of this phenomenon are presented by the sun, moon, and stars. The sun, viewed with the naked eye, appears very much larger than when the light is modi-

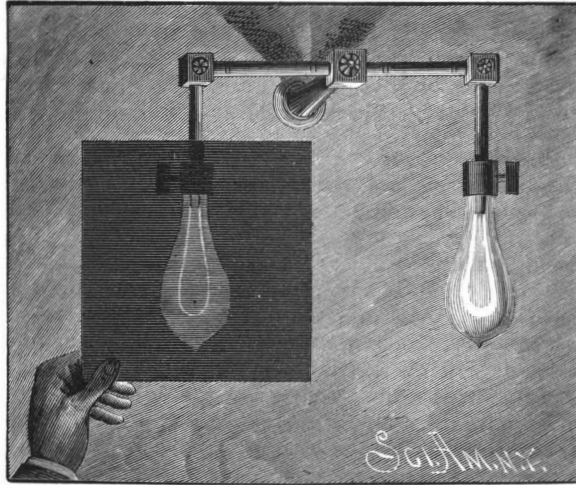

AN EXAMPLE OF IRRADIATION.

fied by a smoked glass. The crescent of the moon appears to project beyond the moon's periphery; and the stars, which are mere points of light even when viewed through the largest telescope, appear to the eye to have a disk of some size.

This phenomenon—known as irradiation—is due to the stimulation or sympathetic action of the nerves of the retina adjoining those which actually receive the image.

The ends of pieces of iron heated to incandescence by the blacksmith for welding seem to be unduly enlarged—an appearance due to irradiation.

Without doubt the most striking illustrations of irradiation are to be found in electric illumination. The

electric arc, which is no larger than a pea, appears to the eye as large as a walnut; and the filament of an incandescent lamp, which is scarcely as large as a horse-hair, appears as large as a small lead pencil. In viewing an ordinary incandescent lamp, it is difficult to believe that the delicate filament is not in some way immensely enlarged by the electric current or by the heat, but the experiment illustrated by the engraving shows that the size of the filament is unchanged, and proves that the effect is produced in the eye.

The experiment consists merely in holding a smoked or darkly colored glass between the eye and the lamp. The glass cuts off a large percentage of the light, and enables the eye to see the filament as it really is.

The effects of irradiation are different in different persons, and they are not always the same in the same person.

**Painting on Cement.**

According to the *Bulletin de la Ceramique*, it is known that the caustic lime which is not in a state of combination in cement saponifies the oil used in painting. Consequently, painting on cement is only practicable when, under the influence of the air, carbonic acid has united with the caustic lime to form carbonate of lime. When it is desired to paint cement without delay, attempts are sometimes made to neutralize the lime by acids; but the above named journal recommends in preference the use of carbonate of ammonia, the acid of which combines with the lime while the acid is liberated. The effect produced is, however, only superficial. Various other expedients are referred to, but the solution of the problem would seem to consist in the use of caseine. Fresh white cheese and slaked fat lime are added to the color. This mixture hardens rapidly, assumes the consistency of stone, and is insoluble in water, a formation of albuminate of lime taking place. It is according to this system that the mural paintings at the Berlin War Museum were executed.

To make the composition, three parts of cheese and one of slaked fat lime are stirred, the quantity of color to be added being regulated by practice. Only earth colors or oxides of iron would be used for light red to dark brown shades; for blue, ultramarine or cobalt blue would be used; for white, oxide of zinc or sulphate of baryta; and for black, animal black. Inorganic colors, such as those of aniline, would not be used, nor would Prussian blue, vermilion, blue ocher, and white lead be employed, on account of the injurious effects of the sulphur present in the cheese in combination with these substances.

If the painting surface is too dry, it can easily be dampened. The caseous lime should be prepared daily, and the brushes should be cleaned after the application of each coat of paint. The process thus described is recommended for its economy, the walls of a house being painted as fast as the scaffolding is removed. The caseous paint does not easily take fire, and is, therefore, considered particularly suitable for the decoration of theaters and for application to stage carpenter's work generally.

**Photographic Printing Board.**

J. Stern, of Munich, has invented a new form of printing board, which tends to do away with the heavy and expensive printing presses now employed to obtain paper positives. This instrument is composed of a wooden board, being hinged into two pieces, which has been covered with some soft material—as, for instance, with felt—and against which a glass plate, placed over the sensitized paper, is pressed by means of metal springs or levers. To each corner of the board is attached one of these levers, each of which consists of two arms of different length. The shorter arm presses against the glass plate, while the longer one can be turned and bent by pushing it down to the pin. By reason of the considerable difference of the two arms, a great pressure is exercised on the glass plate, so that the negative and the sensitized paper will be kept tightly in position during the printing process. The idea, though not a quite new one, is well carried out, and the apparatus is likely to prove practically useful.

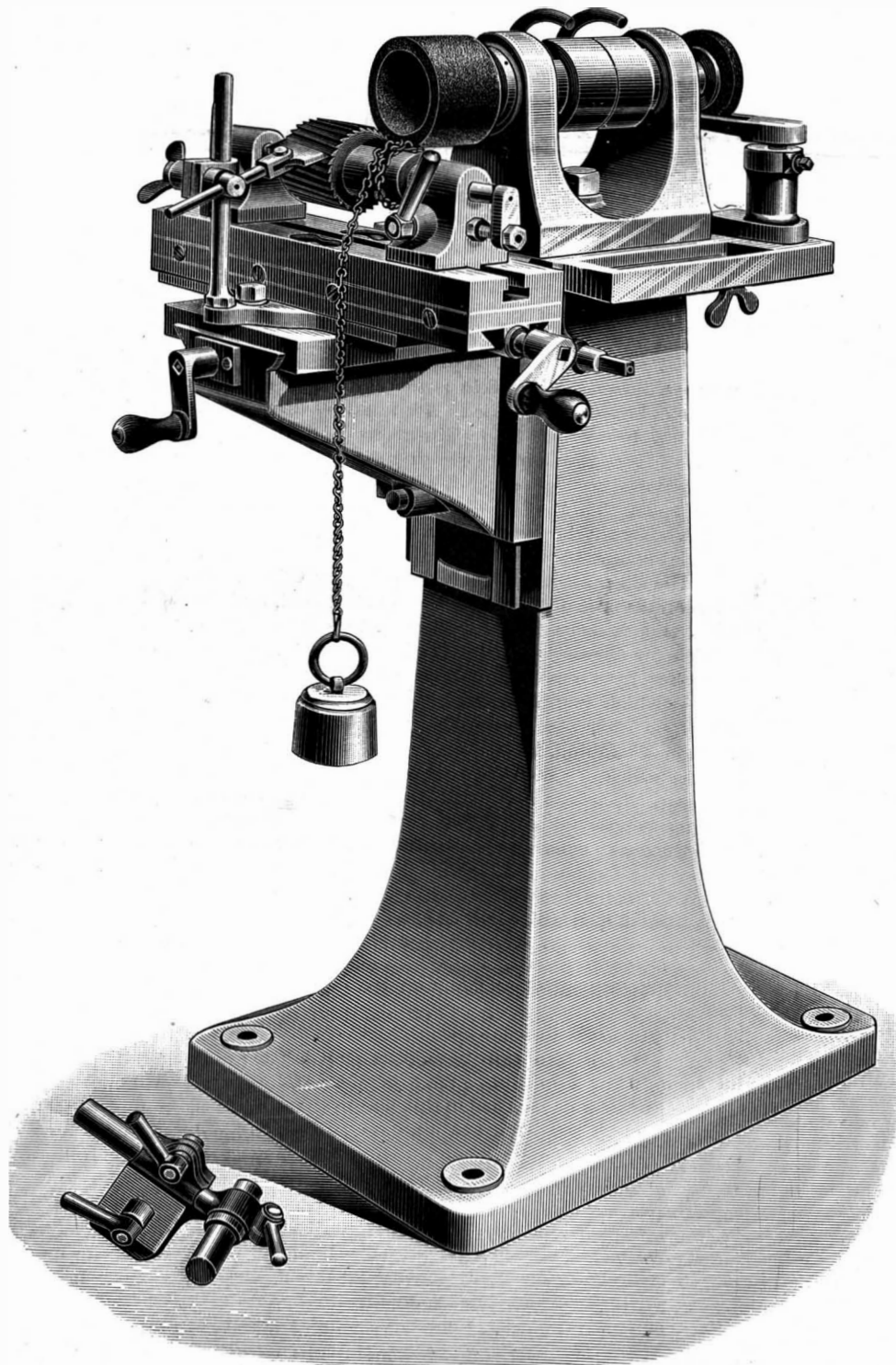

IMPROVED CUTTER GRINDER.]



**AQUARIUMS FOR AMATEURS.**

One would scarcely believe it possible to keep such a beautiful collection of plants and living creatures in the household as is shown in the accompanying illustration; but this is an exact representation of an aquarium belonging to Dr. Karl Russ, to whose article in the *Neue Illustrirte Zeitung* we are indebted for the following:

A consideration of the subject will show that, aside from the few who are interested in fish culture from a scientific standpoint, amateurs soon tire of their aquariums, and their collections end where they began. This, we think, is the fault of those who first introduced room aquariums, and who had either very little experience or too many prejudices, one of the worst of which was the idea that the fish must have fresh water once a day or once a week. If this system were carried out, it would soon render life a burden to the occupants of the tank as well as to its owner. The chief requisite for the preservation and beauty of an aquarium is a luxurious growth of plants in the same, for only under such conditions can the fish live and thrive.

It is well known that the tank should be rectangular; a round tank is as bad for fish as a round cage for a bird. The bottom should be covered four or five fingers deep, the deeper the better, with carefully washed sand, and over this should be scattered all kinds of shells, pebbles, bits of coral, etc. These are ornamental, and will also help to keep the sand in place. In the center or at one side, there should be a rockery to serve as a hiding place for the fish, etc. Calcareous rock is the best for this purpose. After all this has been arranged the water should be poured in carefully, filling the tank to within two or three inches of the top, and then it should be allowed to stand for about a week. After the sand has settled and the water is perfectly clear, the plants can be put in it. Then we shall have a perfect aquarium ready for the fish, etc. As the water evaporates, it should be replaced from time to time, keeping the level the same. The fish can be selected to suit the taste and judgment of the owner.

There really is no limit to the wealth of plants which can be used for this purpose. Many can be found in the neighboring streams, ponds, and swamps, and innumerable foreign plants can be obtained from florists. There are the floating or swimming plants, and those with roots, all of which must be watched carefully, dead leaves and stems being removed before they can pollute the water. After the plants have begun to thrive, if the water has no bad odor, the aquarium can be stocked with fish, but the choice of the latter must depend upon the object of the owner, whether he wishes to use his tank for breeding purposes or designs it simply for his own pleasure and amusement. In the former case, the fish must have a certain amount of shelter and quiet, and the young must not be exposed to destruction by other occupants of the aquarium. The reader may be surprised that I should speak of breeding fish in the home, but it can easily be done, and one of the best fish for this purpose is the Chinese paradise fish (*Macropodus venustus*). It has been a great favorite with amateurs of late years, and bids fair to become as familiar a sight in the household as the canary. A tank holding a cubic foot of water will answer for a paradise fish, though, of course, the larger the better. These beautiful, bril-

liantly colored fish begin to spawn in June or July. The male makes a nest of mucus, and in this the eggs are deposited. As soon as the young fish begin to swarm from the nest, the old ones should be removed to another tank, where they can give all their attention to the second brood, and so that they will not devour the first brood. I have found, however, that the young live perfectly well, in many cases, when left with the parent fishes.

Another fish which can be recommended for breeding purposes is the stickleback, which, like the paradise fish, builds a nest in the aquarium, but instead of building it of mucus, uses vegetable fibers, etc., much as birds do. The stickleback is more difficult to keep in

meat, and only as much of one of these things should be given at a time as will be eaten. To avoid having uneaten bits left to pollute the water, a number of snails should be kept in the aquarium, care being taken that the number shall not be too great, for the snails destroy the roots of the plants. When there are pike, perch, or other fish of this kind in the aquarium, they should be supplied with small whitefish and other young fish which can be obtained of dealers, and which are used only as food for the larger fish. In the summer, water flies and other small creatures should be caught in neighboring ponds and streams, and put in the aquarium. But the fish should never be fed with crackers, white bread, seeds of plants, or food different from that mentioned above.

**California Fruit.**

The growth of the California fruit trade continues to be marvelous. A Fresno firm, says the *Graphic*, sends East this year about 300 car loads of raisins. It is only about ten years since the first experiments in raisin packing were made. The grape used had long been known, however, as the "raisin grape," and it continues to be the favorite for that use. It is a white grape, and grows in comparatively small bunches, and the skin is so tender that a bunch may be bruised into jelly by merely shaking it, the skins breaking by contact with each other. It is very delicate in flavor as well as texture, but, like most of the choicer varieties, is, of course, much too frail for any kind of shipment yet discovered. Very few varieties of the California grapes are sent here. Over two hundred are commonly grown there, and there is such a vast variety among them that they are often like entirely different species of fruits.

The making of wine has also only been brought to any degree of excellence within less than ten years, but in that time California wine has made an immense impression on the market. The grape used almost altogether for wine is called specifically the "California grape," or sometimes the Mission grape, because it was introduced into the country by the first Spanish missionaries, and was grown to a large extent before any American settlements were made. It is not known from what stock it came, so distinctive has its character become. It is individually small, but the bunches are immense, from six to ten pounds, and in exceptional cases much more. The wine is very prolific. The time is not far past when this grape was such a drug in the market that some seasons it would be exchanged

ton for ton for hay. Wine making has changed all that now, however.

**The Lowest Record in Working Gold Ores.**

When gold ore can be mined in California for 37½ cents a ton, and milled for 23 cents per ton, it is getting the business down to a very fine point, and augurs well for the future of California quartz mining. And this has just been accomplished—not with a small test run of 20 or 30 tons of ore, but with nearly 3,000 tons. It will astonish many persons to learn that ore worth only \$1 16 per ton can be moved and worked without loss, and still more surprise them to know that ore of that value is paying about 56 cents per ton profit.

This record was made recently at the Spanish mine, Washington Township, Nevada County.—*Min. and Sci. Press.*

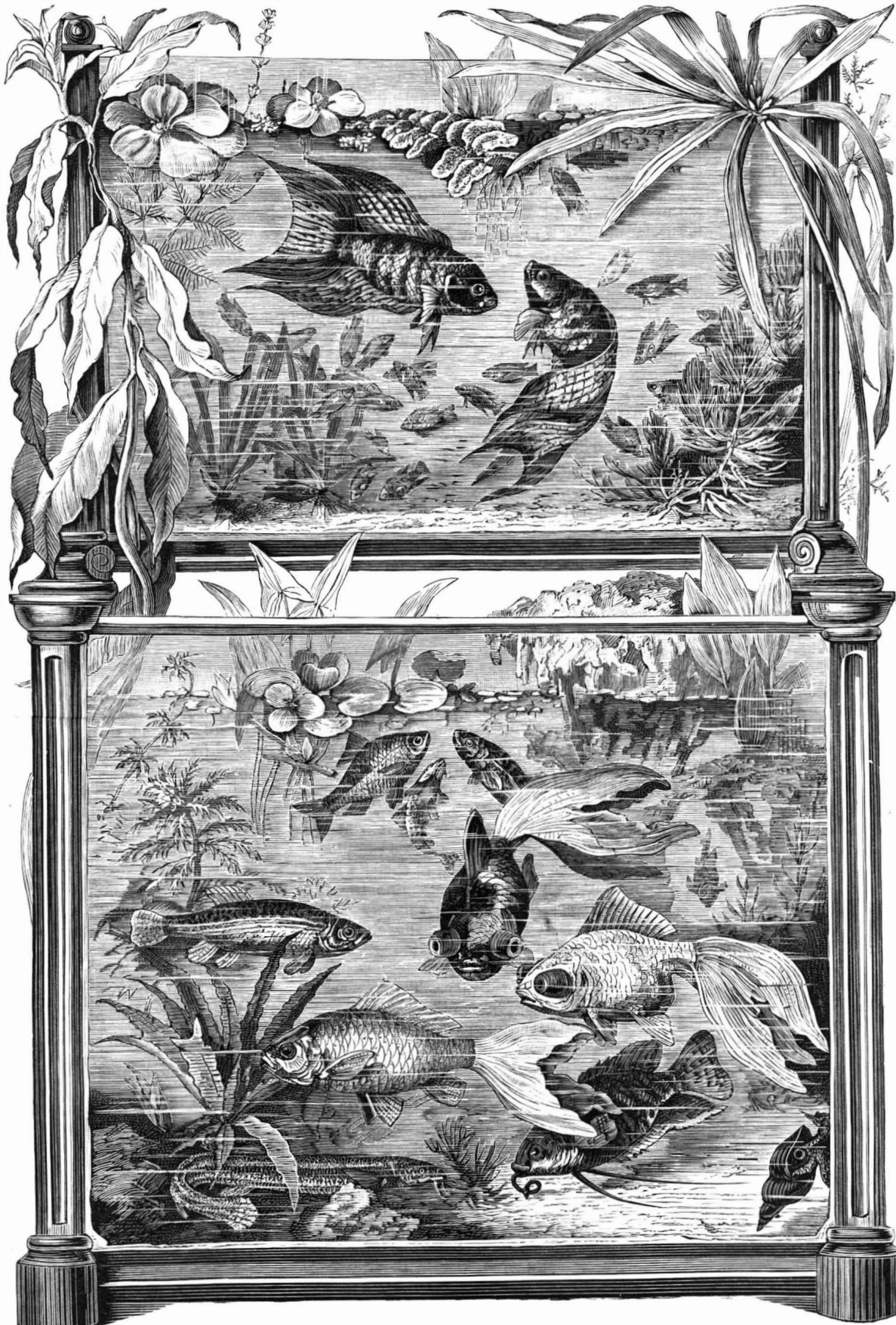

**AQUARIUMS FOR AMATEURS.**

captivity than the paradise fish, and more care is required.

This fish culture is, on some accounts, rather difficult, and an easy way is to obtain eggs from breeders, and hatch them in the aquarium. Eggs of the carp, gold fish, etc., can easily be hatched in this manner, specially if a canal or small stream is available for the purpose, and the amateur can gain much pleasure and amusement as well as valuable information from such an undertaking.

For an ornamental aquarium, such as is shown in the cut, fish should be chosen that will give variety of form and color, and the plants should be abundant, and frequently renewed, for gold fish and many others live partly on the plants, destroying their roots.

The fish should be fed on the pupæ of ants and other insects, worms, and fresh, raw, lean, and finely chopped

**Niagara Falls Water Power.**

About six months ago, Mr. James B. Stafford, of Buffalo, N. Y., in connection with others, offered a large prize of \$100,000 in money for a contrivance that would convert the flow of water in Niagara River into practical power.

The prize has not yet been awarded, nor has any fixed standard of efficiency been determined upon, although many plans have been received. The various contrivances will, it is said, be placed on exhibition as soon as the \$100,000 committee are satisfied that the subject has been exhausted. The prevailing opinion, as ascertained from the inventions offered, appears to be that the mighty river must be set to work by means of a current wheel, or by some modification of it.

Recently the Buffalo papers announced that a practical test was to be made of one of the contrivances. The inventor has conceived the idea of catching the force of the current on paddles fixed on an endless chain, the whole to be sunk in the river so as to be below the ice in winter, the freezing over of the stream being an apparently insurmountable obstacle in the way of a surface current wheel. The paddles or buckets on the proposed chain are to be attached by hinges, so to speak, so that they will be perpendicular to the current when passing down stream and parallel with it when returning up stream. The construction is thus similar to that of "feather" paddles on a steamboat. The endless chains communicate the power of the current to wheels over which they pass, and by shafting to practical machinery. This submerged oblong current wheel is geared upon a float which is sunk to the bottom of the river, or to a required depth, and there securely anchored. Having air-tight compartments, it can be raised when desirable by pumping out the water.

These experiments for obtaining power at Buffalo are not favorably regarded by some practical men as compared with the other project now in hand at Niagara Falls.

In view of the fact that the level of the great river at the head of the rapids is, in round numbers, 200 feet above its level at the foot of the cataract, Mr. Evershed proposed to bore a tunnel from the lower level to a point coinciding with the upper level. Starting at the base of the precipice below the falls, the tunnel, which it is proposed to make twenty-four feet in diameter, it is proposed to construct directly under the village, and to follow the line of the shore above the falls at a distance of about 400 feet from it. At a distance of one mile the tunnel will be 124 feet below the surface, at a mile and a half 97 feet below the surface, at two miles 85 feet below, and at two and a half miles 76 feet below. Now, this tunnel is not for the purpose of conveying water to water wheels, but solely for carrying it away from such wheels. It is to be a tail race simply. The mile point, where the subterranean tail race is 124 feet below the surface, is beyond the limit of the State reservation, above the rapids and coincident with the safely navigable water of the river. From this point along the river as far as the tunnel may be extended—the present plans providing for only a mile and a half—the water power will be available by sinking shafts from the surface to the subterranean tunnel or tail race, and planting turbine wheels at the bottom of them, geared by upright shafting to the machinery of mills or factories. The "head" or height of fall down the first shafts at the mile point of the tunnel will be 124 feet, the wheel pit being at that depth below the surface; at the mile and a half point the "head" will be 97 feet, and so on, the average head for the mile and a half provided for in the present plans being 120 feet. The water is supplied by conduits from the river, and transverse tunnels for wheel pits and tail races are to be cut corresponding with the surface conduits, thus enabling mills to be erected not only along the line of the main tunnel, but on these transverse conduits.

The financial possibilities of the undertaking remain to be wrought out. In 1886 the legislature granted a special charter to a company of gentlemen of Niagara Falls and elsewhere, with a nominal capital of \$200,000, with power to increase it to \$3,000,000. The engineer's estimate of the cost of constructing the main tunnel, twenty-four cross tunnels, four shafts, twelve feed race-ways or conduits, and other necessary works is \$2,250,000. The land plan of the company is to grant mill rights on lands which they have already acquired or stipulated for, along the river at the head of the proposed tunnel, at a nominal price, practically giving them away, and to depend upon rentals of power for returns on the investment. The entire plant as covered by the \$2,500,000 estimate of cost will develop 119,000 horse power, or 238 mills and factories of 500 horse power each. The present financial plan provides for renting this power for \$10 a year per horse power for twenty-four hours a day, it being taken for granted that the supply of water might as well be for every hour as for less, since there will never be any need for economizing. This is only half the rates paid by mill owners for water power at Cohoes, Holyoke, Lawrence, and Lowell, while at each of those places the time is limited to eleven hours a day. The

promoters of the Niagara Falls enterprise claim that they will be able to furnish the simplest, most abundant, and cheapest power in the world. They are delayed by some financial complications which they expect will be removed at an early day. So says a correspondent of the New York *Evening Post*.

But if the developments of natural gas progress in the future as much as they have in the past, water power will not prove so advantageous after all. In some of our Western towns they are offering to supply manufacturers who will locate there, the free use of gas for fuel both in their factories and homes. Thus the settler may obtain light, heat, and power in unlimited quantities for nothing. This beats Niagara cheap water power all out.

**Methods of Distributing Natural Gas to Consumers.**

BY WM. D. HARTUPE, MANAGER CHARTIERS VALLEY GAS CO., PITTSBURG, PA.

Explosions have occurred in the past with natural gas that have been attended with loss of life and destruction of property, but the greatest number and most disastrous occurred when the business of conveying the gas was comparatively new, and each explosion was clearly traced to a cause which, in almost every case, was due either to defective valves, tees, elbows, and the general fittings that were put in the main lines, or to the fact that these fittings were too light to stand the work required of them, added to which was the fact that sufficient care was not exercised in putting the work together.

But the gas companies have made great changes in their methods of procedure since these accidents occurred. All the fittings used are made enormously heavy; complete systems for carrying away any escaping gas have been adopted; more skillful men are employed, and more care is exercised in the general supervision of the lines and different connections to prevent, to discover, and to repair leaks. In short, everything has been done by most of the companies that foresight or ingenuity can suggest to render the conveying of this subtle fluid safe and free from accidents.

The recent explosion was the result of carelessness—carelessly neglecting to shut off the gas while making a connection. It was surely carelessness, that surprises the other gas companies themselves more than it does the public who are unacquainted with their rules, for they have long since forbidden such risks to be taken.

All the gas companies, we believe (with the exception of the People's Gas Company, which seems to be a law unto itself), that are producers as well as distributors of natural gas for these two cities of Pittsburgh and Allegheny, are working under council ordinances which regulate the pressure to be carried and the way the pipes are to be laid. The gas is carried from the wells (generally in wrought iron pipes tested to stand a pressure of at least 500 pounds, and sometimes as high as 1,000 pounds) to the city line at a high pressure. At or near the city line the gas is passed through automatic regulating valves, and the pressure is reduced to that specified by the city ordinance. It then flows into much larger pipes (in order to make up in volume what the gas has lost in pressure), and is conveyed through the city. The pressure which is carried in the city is about fifteen pounds to the square inch, and the lines which carry this pressure we call our "mill supply lines," to distinguish them from our house supply lines, of which we will speak later on.

Upon every line of this character within the city limits, the Chartiers Valley Gas Company places their patented escape system for conveying away any gas that may leak out at the joints, that has been pronounced by many experts as more efficient than that used by any other company, and has been recommended by visiting natural gas committees from other cities after thoroughly examining all the other devices in use.

Our system consists simply in placing a sleeve over every joint in the gas line, first seeing that our joints are absolutely tight under pressure, and having them passed upon by the city inspector. This sleeve is made perfectly gas tight around the pipe, by means of lead or other suitable material. On the inside of the sleeve a space or chamber is left, so that any gas that escapes from the joint on the main line is collected in this chamber. Connected with this chamber at the top, a small pipe leads off and up into a lamp post situated at the curb. Each joint has its own separate and distinct escape pipe, and several escape pipes may be run into one lamp post. Each joint is numbered, and its exact distance measured from the lamp post.

The escape pipe that leads away from the joint is marked with the corresponding number at the top of the lamp post, so, if gas is found escaping at the top of the lamp post, by noting the number of the small pipe through which it escapes, the exact location of the leak can be determined.

In addition to this "patented separate pipe escape system," as it is called, the Chartiers Valley Company takes the further precaution of covering all its pipes with broken stone for a height of nine inches above

the main, and at every 90 or 100 feet leading this broken stone by means of a cross ditch to the foot of a lamp post, so that any gas that escapes from the body of the pipe would find its way through this "French drain," and through the lamp post into the open air. Before the ditch is filled, a double layer of tarred paper is placed over the broken stone to keep the dirt away from it. (This broken stone system is also patented and controlled by the Chartiers Valley Gas Company.)

With such a system we believe that it is impossible that any escaping gas would find its way into cellars or sewers, for, with a free, uninterrupted opening into the air, it would invariably seek that course in preference to any other, in addition to which the lamp posts create a draught that tends to draw the leaking gas away from the line.

A gas company's "house supply system" deserves especial attention, for while the "mill supply system" of any company covers but a comparatively small part of the city, the house supply lines are laid on almost every street, lane, and alley. There are two distinct systems for supplying natural gas to private houses in this city, one of which is the Philadelphia company's system and the other is the Chartiers Valley Gas Company's system. The system adopted by the former company consists in a network of pipes laid through the city, generally made of wrought iron, and about four inches in diameter, and connected at certain points with their mill supply system, by regulating valves so set that five pounds is received into and carried on the house supply lines from the mill lines. Now, to reduce this pressure, which is too great to be conducted into a house, a regulating and so-called automatic shut-off valve is used, which reduces the pressure to four ounces or thereabout, which is the proper pressure of gas for burning in private houses.

The advantages of this system to the Philadelphia company are, first, that by carrying a high pressure of five pounds on their house supply lines, they are able to use much smaller pipes than they could if only four or five ounces were carried.

A good automatic regulator and shut-off valve is a good thing if rightly constructed and carefully looked after; but let such a valve be placed in a damp cellar and not looked after, the people in the house perhaps forgetting that it is there at all, now let the main line break after the valve has been in place a couple of years, and in nine cases out of ten the valve will be rusted and will not operate.

The system of house supply adopted and used by the Chartiers Valley Gas Company consists in laying an entirely different network of pipes from its mill supply system, but connected with this system by means of regulating valves, the same as the Philadelphia company's is; but it differs in this important point, that the Chartiers company lays pipes to supply the private houses so large that a pressure of only four ounces need be and is carried on them. The service pipes are then run direct into the consumer's house, no regulating valve or other device being necessary, as the pipes themselves carry no more than is required in the houses.

The question may be asked, Are not the valves that control the pressure between the mill supply line and the house supply line liable to get out of order and let a higher pressure into the houses than would be safe?

We answer, yes; very liable; but of these valves in the entire city there are but four, and there will never be more than eight, and to watch them the Chartiers Valley Gas Company keep watchmen night and day whose sole duty it is to see that these valves are always in order.

In laying its lines for house supply, the Chartiers Valley Gas Company also puts in a thorough broken stone escape system, connecting the stone drain with a lamp post placed every 300 feet along the line.

The statement has been made in the papers that the life of the natural gas companies' pipes underground is but five years, after which they become rusted out and will not hold gas. This statement is not true. There are pipes made of cast iron and laid by the Pittsburgh Gas Company, in this city, that have been down thirty-five years, and are still in good condition. A cast iron pipe, as laid by the gas company, will be absolutely safe for thirty years of service, and a wrought iron pipe for twenty years of service. This statement can be verified by nearly every water works superintendent in the country.—*Insurance World*.

**The Heathen Chinese.**

The Secretary of State is in receipt of a note from the Chinese minister here, returning, by direction of his government, a portion of the Rock Springs indemnity, lately appropriated by Congress, which represents the amount of six claims, which, in the final distribution of the appropriation, have been ascertained to be duplications. Mr. Bayard has appropriately acknowledged this honorable action of the Chinese government, and the amount so refunded will be covered into the Treasury.

Correct book keeping must be at a discount at the Treasury department in Washington, if the above example of duplicate payments is a fair specimen of official abilities.

**ELECTRIC WELDING.**

(Continued from first page.)

ening screws, bolts, bars, or shortening them by cutting out sections, and for renewing the cutting edges of lathe tools. The number of applications of electric welding to work of this kind seems to be almost endless. Electric welding is adapted to much of the work of the jeweler. A large proportion of the gold work now soldered may be welded. In the manufacture of gold rings it will be particularly advantageous, as it renders the ring of uniform fineness throughout.

For welding electrically, a current of great volume or quantity and very low electromotive force is required. It may be furnished directly by a dynamo of peculiar construction, or the current from an alternating machine of high electromotive force may be used by employing a transformer capable of delivering a current of low electromotive force and great volume. Practically, the current used in welding has an electromotive force of from 1 to 2 volts, while its volume may range from 1,000 to many thousand amperes, depending on the nature and size of the bodies to be welded.

In the exhibit at the fair, the primary current is furnished by a Thomson-Houston self-exciting alternating current dynamo. This current, circulating in the primary wire of an induction coil of peculiar construction, generates in the secondary conductor of the coil a current suitable for welding purposes. The dynamo used in the present instance consists of series of field magnets arranged in a circle and connected so as to present opposite poles in alternation. The armature consists of a series of thin iron disks fastened together to form a cylindrical core, and a number of flat spirals one wire in depth, mounted on the periphery of the core and connected with two terminals leading to two collector cylinders on the armature shaft. Under the flat spirals, or "pancake coils" as they are called, are placed a few coils arranged according to the Siemens system, and connected with a commutator upon the end of the hollow shaft. The current taken from this commutator is employed solely for exciting the field magnet, while the alternating current from the collectors is used in the welding apparatus.

Referring to Fig. 2, the current from the dynamo is conducted to one binding post of the commutator, 3, which is arranged to send the current through  $\frac{1}{2}$ ,  $\frac{1}{3}$ , or  $\frac{1}{4}$  of the primary wire, P, of a transformer or induction coil. The primary wire of the transformer is small and long. The secondary conductor, S, is very large and short, and the body of iron forming the magnetic field is placed in proximity to the primary and secondary conductors. The remaining binding post of the commutator, 3, extends to one terminal of an isolated primary coil, 4, the remaining terminal being connected with the dynamo. The coil, 4, is provided with a switch by which any number or all of its convolutions may be cut out or placed in circuit at pleasure.

The rods to be welded are placed in the clamps, C C', the fixed clamp, C, being connected with one terminal of the secondary conductor, S, the movable clamp, C', being connected electrically with the remaining terminal of the secondary conductor. The movable clamp, C', is arranged to be moved forward toward the fixed clamp, C, by means of a screw. The rods are filed and rendered slightly convex at the abutting ends, and the rod carried by the movable clamp is brought into forcible contact with the rod supported by the fixed clamp, when an appropriate flux is applied. The current is then switched on to the primary in such a manner as to cause it to traverse  $\frac{1}{2}$ ,  $\frac{1}{3}$ ,  $\frac{1}{4}$ , or the whole of the wire, according to the requirements of the work in hand; or the two halves of the primary may be arranged in parallel circuit.

The contact surfaces of the rods to be welded at once begin to heat, and the movable clamp, C', may be advanced as fast as the softening of the abutting ends of the metal will permit.

For the nicer adjustment of the current, more or less of the coil, 4, is introduced into the circuit by means of the switch, and the inverse electromotive force generated in this coil serves to oppose the action of the current in the primary coil, P, more or less.

When the weld, W, is complete, the primary circuit is interrupted and the work is removed from the clamps. The time required for producing a perfect weld is but a few seconds on ordinary work. The work may be hammered while the welding progresses, and it may be even removed from the clamps and hammered, replaced, and reheated, if necessary, the heated portion of the metal increasing the electrical resistance so as to confine the further heating to the same part of the metal. One of the important features of this invention is

stated that the process has been in operation some time, and that from 170 pounds to 180 pounds of fiber are produced at each filling.

**Fiber-Producing Plants in Burmah.**

Attention is drawn by *Indian Engineering* to the fact that Burmah abounds in fiber-producing plants, of which the bamboo is the principal. If the bamboo were dried and exported, it would, on arrival at its destination, be found to be too hard for manufacture into paper, and additional expense would be incurred by having to boil it at high pressure for that purpose. The course recommended is to pick only the tender stems of the bamboo, to boil them in caustic alkali, and then to wash, tease, and dry them before packing into bales for export.

The most favorable sites for erecting such factories would be the banks of the Irrawaddy and Salween, as both localities are in easy communication with the interior, as well as the principal seaports. Besides preparing paper stock, the fiber of the plants can also be prepared for spinning purposes. The mode of treatment is very similar to that followed in the preparation of paper stock, care only being taken in the selection of bamboos, those possessing the least knots or largest internodes being best suitable; and such species are common and abundant in Burmah.

The fibers of bamboo, China grass, and pineapple can be similarly treated as jute, and spun so fine that an expert could barely distinguish the product from real silk. It is also stated that these fibers possess an advantage over jute, as they require very little chlorine when bleaching, while jute requires a large quantity, and even then a pure white is not obtainable without serious deterioration to the strength of the fiber, which is the inevitable consequence where a large quantity of chlorine is used. At the present time large quantities of cloth woven from China grass and bamboo are brought into the Rangoon markets by Chinamen from Bhamo, and although the material is not manufactured with modern looms, still the quality is so fine as to resemble tussore silk.

**THE L. W. POND IRON PLANING MACHINE.**

The accompanying cut represents one of the iron planing machines for heavy work designed and manufactured by the L. W. Pond Machine Co., 140 Union Street, Worcester, Mass. The bed is made very long in proportion to the length of the table, and enables the machine to plane from four to sixteen feet in length. The table is heavy, and an oil channel is cut the entire length of the slide, keeping it perfectly lubricated and preventing cutting on heavy work. There are three bolt slots running the entire length of the table. The posts or uprights are very heavy, with large breadth of base, and are firmly bolted to the bed. The driving shaft is made of steel. The cross bar is strong and heavy, and is adapted to be quickly adjusted by the raise and fall screws. The feed is transmitted to the cross, down, and angle screws through the driving shaft, by a recently patented device, and runs perfectly free and loose after having done its work at the end of the stroke. The reversing motion is also of an improved patented form, and can be easily adjusted to give either belt more or less lead, and it is entirely under the control of the operator at any part of the stroke.

The *American Stationer* tells its readers how they can write upon egg shells and leave the impression of engraving. The editor says all that is required is to write upon the egg shell with wax or varnish, or even tallow, and then immerse it in some weak acid, such as dilute hydrochloric acid or vinegar. The acid eats into or dissolves the lime of the egg shell, and thus the writing is left in relief. This may be successfully

performed on the first experiment, although a few precautions will be found necessary. As the eggs used are usually blown, in order that they may be preserved, the holes should be plugged with wax and made airtight. As they will be found very light, some method should be devised for holding them under the surface. Two or three minutes will suffice to give the writing the proper relief, but the result will be more satisfactory if the acid is weaker and the time taken longer.

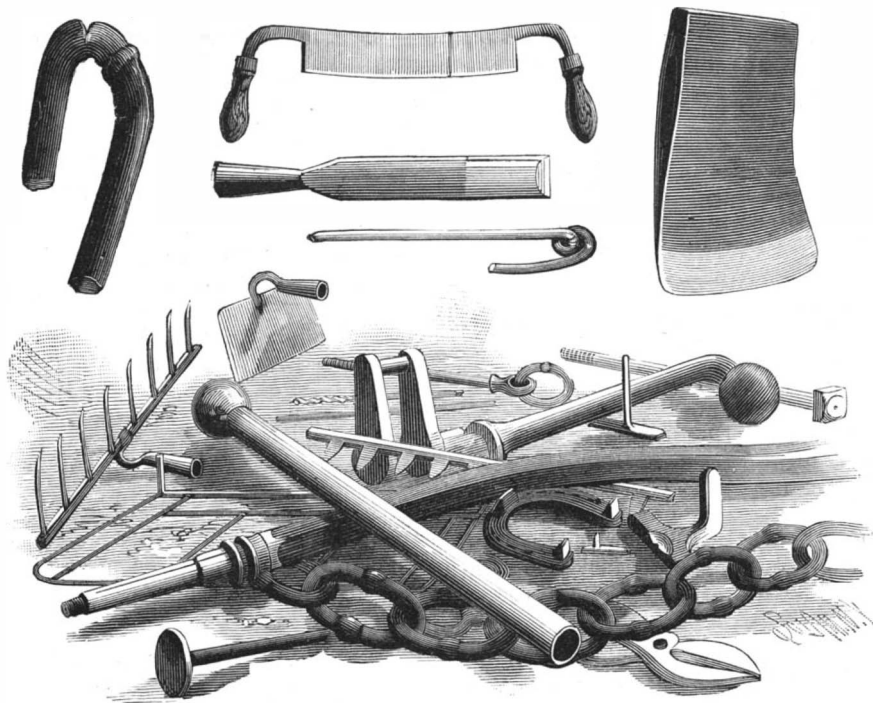

Fig. 3.—EXAMPLES OF ELECTRIC WELDING.

that the metals are heated uniformly during electric welding. This results from the fact that cold metal is a better conductor than hot metal, and that, therefore, any cooler line of particles in the sections at once becomes a path for increased current, and is brought up in temperature to equality with the other portions.

The absence of the dirt of the forge and cinder, common to the old method, is a decided advantage. The process is perfectly safe, and is so simple that it may be easily conducted by unskilled labor. The economy of electric welding is very great, and the range of work to which it is applicable is almost unlimited.

No exhibit at the fair attracted more attention than this. Iron, steel, brass, and copper were quickly welded, and the process was explained by the competent attendant.

The Thomson Electric Welding Co., of Lynn, Mass., are the makers of the apparatus and the promoters of the new art.

**Paper Pulp.**

A new method of preparing cellulose has, according

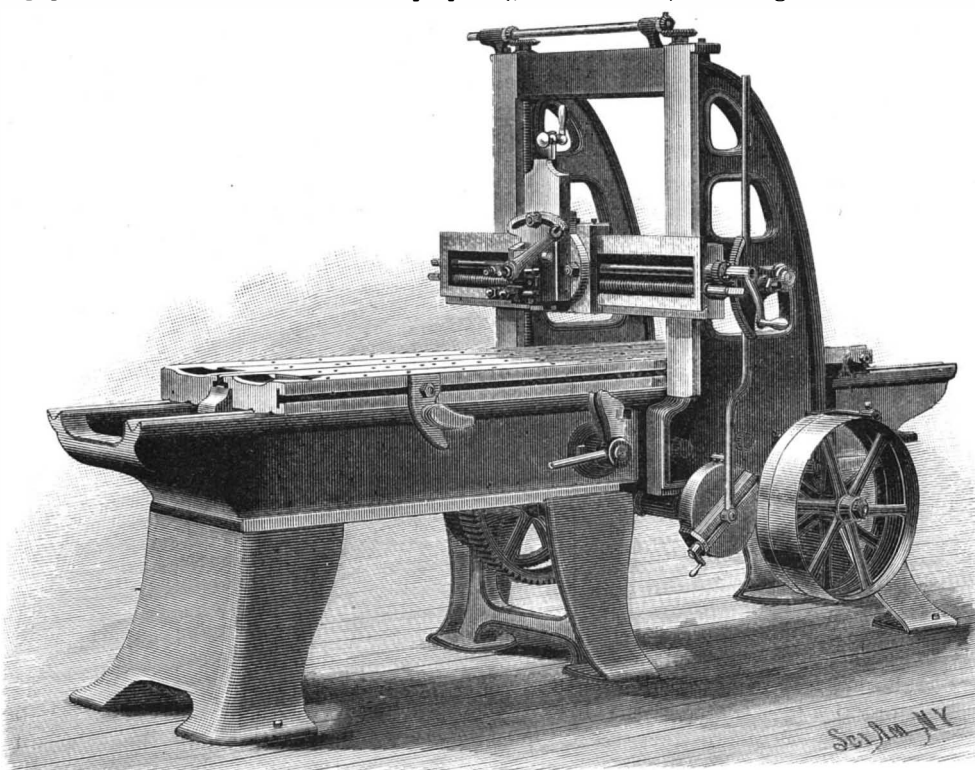

IRON PLANING MACHINE.

to a German paper, been recently patented by a Mr. Kellner, of Podgera, Austria. The inventor produces the pulp by decomposing electrically a solution of certain chlorides, such as common salts; and allowing the chlorine gas thus obtained to act in straw, wood, or other material of similar constitution. The direction of the current is frequently changed, so that the vegetable fibers are subjected to the action of alkaline hydrates, as well as that of the chlorine. It is

**A Crooked Stick Straightened.**

I had an ugly, unruly boy in my room, and he gave me more trouble than all the rest of the class. All through the different grades of the large grammar school he had been a terror to his teachers, and he was hurried on to the next teacher with surprising alacrity and precision. He never lacked promotion. When I inherited him I felt as if Nemesis had overtaken me, and just how to control him and secure any kind of work from him was a problem I long wrestled with. For several weeks he was the terror of the room, and my reputation for good order and dignity was, I felt, fast disappearing. The boy would not obey unless he felt like it, and punishments had no effect on him. He was there, he knew he was there; he had a reputation to sustain; he had earned it by several years' close application to wrong doing, and he meant to maintain it at all hazards.

It is unnecessary to narrate his pranks. Every teacher has had such boys, and will readily recognize this one. Every plan I evolved for the regeneration of the boy proved abortive. He wouldn't reform. Finally, by accident, I stumbled on the cure. I am not ashamed to say that it was an accidental plan, for it was one of those unexpected things that philosophers tell us are bound to come to pass.

I discovered that he was interested in his drawing, or rather was interested in sketching odd bits of scenery, or objects in the room, not even omitting his respected teacher, who was a typical schoolmarm and wore glasses. I resolved to make the most of this one talent—if talent it was—and so one day, when I was in my best and sweetest mood, I asked the terror if he would not draw a plan for some shelves I wanted put up in my closet. He assented, and the sketch was neatly and accurately made. There was a new look in his eyes and a new expression on his face when he gave me the paper on which his drawings were made.

Then I advanced slowly and cautiously. I needed some maps made, following a new invention of mine in cartography, and again I employed the terror, and again the result was encouraging. The maps were models of neatness and precision. I judiciously praised him, and exhibited the maps to the class and called for copies. None ever equaled his, and his joy was complete.

We were studying the continent of Asia, and the terror never had his geography lesson learned; but when I suggested that if he were to keep up his reputation in drawing he must draw the details of the country he was sketching, geography became a new study to him, and he easily made excellent progress in this branch. To do this he had to forego some of his "fooling business," and it was given up simply because he had something more to his liking to do.

In fine, and to the point, the terror came out of his chrysalis state a new creature. His old ways were left, and he readily adopted the better method of doing and living. From a slouching, unkempt, uncouth, shambling, horrid boy, he emerged into being a respectable, neat, tidy, order-loving, painstaking, and industrious young man. I had found that there was something he could do, and something he liked to do, and that was all there was to it. By doing something worth the doing he had no time or liking for doing what was not worth the doing, and mischief became no longer the object of his existence.—*Winthrop, Amer. Teacher.*

**Wave Power Motor.**

The *San Francisco Call* gives a graphic account of a new wave power motor just finished and proved a success. The construction of this machine or apparatus, which was begun in July, 1886, was at the time considered a half-brained scheme, but the projectors stuck to their plan, and seem now to be in the fair way to success. Great difficulty was experienced at first in getting the materials to withstand the force of rocks thrown against them by the waves, and the pipes which conduct the water up the bluff were broken and carried away no less than fourteen times. When the schooner *Parallel* went ashore and her cargo of dynamite exploded, the motor was completely wrecked. A mass of rock weighing six hundred tons was thrown from the cliff and fell across the chasm over which the motor was suspended, blocking it up to such an extent that nearly three months were consumed in blasting out the debris. Soon afterward another mass of stone weighing one hundred and fifty tons fell and had to be removed. The motor, which was designed and built by E. T. Steen, is a very simple contrivance, and still is capable of exerting great power.

Across a chasm in the rocks just north of *Parallel Point*, a bridge of heavy timbers was built. Suspended from this is a huge fan or paddle of oak timbers with the spreading portion downward. This is fastened to the bridge by immense hinges, which allow it, when in operation, to swing back and forward a distance of six feet as the waves strike it. The handle or upper portion of the fan is connected with a solid plunger pump 12 inches in diameter and having a stroke of 9 to 12 feet. This pump, in turn, is connected with a suction pipe running out into deep water. The fan is so rigged that it can be drawn up out of reach of the

waves when not in use. When a wave comes in, the fan is thrown forward and forces the air out of the pump barrel in which the plunger works. On the wave receding, the fan is carried seaward and the plunger drawn out, causing a vacuum, and causes a quick rush of water into the suction pipe. The force with which the water is drawn up is sufficient to raise it to an elevation of 350 feet above the sea level.

Should this motor prove as successful as the projectors seem confident it will, several others will be built in the same neighborhood, and an immense reservoir built on the hill to contain the water.

This one motor with its 12 inch plunger is capable of raising 12,000 feet of water 350 feet high in every twenty-four hours. The uses to which the water will be put are various. A 36 inch pipe will be conducted to the city, and water will be supplied to all branches of industry where machinery is used. Bathing houses will also be supplied with salt water, and sewers flushed where it is necessary.

The first work performed will be begun in about ten days, and an 8 inch pipe is now being laid for the purpose.

The last mentioned pipe is for Adolph Sutro, and is to be utilized in sluicing away a large amount of drifting sand from the heights just back of the aquarium. This work is rendered necessary to prevent the sand from washing back on the beach and retarding the work there.

The immense fan of the motor generates a large amount of energy which is not used in working the pump, and, when everything is in shape, electric dynamos will be erected to utilize the energy for heating purposes and the like.

**Tempering Springs.**

A correspondent of the *English Mechanic* presents the following with respect to spring tempering:

There is, perhaps, no kind of tempering that requires so much care in manipulation as getting a good spring temper. It is necessary that the spring be carefully forged; not overheated, and not hammered too cold. The one is as detrimental as the other. To insure a spring that will not warp in tempering, it is requisite also that both sides of the forging be equally wrought upon with the hammer. If not, by the compression of the metal on one side more than another, it will be sure to warp and twist.

We will suppose that the article has been carefully forged, finished up, and is ready for tempering. Clean out the forge, and make a brisk fire with good clean charcoal; or if bituminous coal must be used, see that it is well burned to a coke, in order to free it from the sulphur it contains, as sulphur will destroy the "life" of the metal. Then carefully insert the steel in the fire, and slowly heat it evenly throughout its entire length. Give it time to heat through its thickness, and when the color shows a light red, plunge it evenly into lukewarm water, or water from which the cold chill has been taken off, so as not to chill the surface of the metal too quick before the inside can also harden, and let it lie in the water until it is of the same temperature as the water. A much better substitute for water is a good quality of animal oil—whale oil or lard oil is best. As a substitute, we have used lard, by melting it before we inserted the heated steel in it. The advantage of using oil is that it does not chill the steel as suddenly as water, and there is less liability to crack it.

Remove the hardened spring from the water after it is sufficiently cooled, and prepare to temper it. To do this make a brisk fire with plenty of live coals, and then smear the hardened spring with tallow and hold it over the coals, but do not urge the draught of the fire with the bellows while so doing. Let the fire heat the steel very gradually and evenly. If the spring is long, move slowly over the fire, so as to receive the heat equally. In a few moments the tallow will melt, then take fire and blaze for some time. While the blaze continues, incline the spring, or carefully elevate either end, so that the blaze will freely circulate from end to end, and completely envelop it. The blaze will soon die out; then smear it again with tallow, and blaze it off as before. If the spring is to be subjected to a great strain, it will be required to perform much labor—it may be lightly blazed off a third time; and if it is to be exposed to the vicissitudes of heat and cold, it must be left to cool off itself upon the corner of the forge, and not cooled by putting it in water or throwing it on the ground. Spiral springs of steel wire are tempered by heating them in a close vessel with animal charcoal or with bone dust packed around them, similar to the process of case-hardening, and when thoroughly heated cool them in a bath of oil, and proceed to temper them by putting a handful of them in a sheet iron pan, with tallow or oil, and agitate them over a brisk fire. The tallow will soon blaze, and the agitation will cause them to heat very evenly. The steel springs for fire arms are tempered in this manner, and may be said to be literally "fried in oil." If a long, slender spring is needed that requires a low temper, it can be made by simply beating the soft forging on a smooth anvil with a smooth-faced hammer. By

this means the metal will be sufficiently compressed to form a very good spring without further tempering.

Use a light hammer in the process and "many blows," and a spring will be made that will last for a long time where it has to bear no great portion of labor in its action. In setting up old carriage springs where they are inclined to settle, first take the bed leaf and bring it into shape; then heat about 2 ft. in the center, plump to a cherry red; then cool it off in cold water as quick as possible. This will give the steel such a degree of hardness as to be liable to break if let fall on the floor. To draw the temper, hold it over the blaze, carrying back and forward through the fire until it becomes so hot that it will sparkle when the hammer handle is drawn across the edge; then cool off, or not, just as you please. Another mode is to harden the steel, as before stated, and draw the temper with oil or tallow. Tallow is the best. Say, take a candle, carry the spring as before through the fire, and occasionally draw the tallow the length hardened until the tallow will burn off in a blaze, then cool. Every leaf is served alike.

**The Proposed Nicaragua Canal.**

A corps of engineers for the survey and axial location of the Nicaragua Canal has been organized; with Mr. A. G. Menocal, Civil Engineer, U. S. N., as chief, and Mr. R. A. Peary, Civil Engineer, U. S. N., as assistant chief. The engineers are to be divided into ten parties, of which one will be the staff, having general supervision of the whole work; one will have charge of the hydrographic work, including the plans for the permanent improvement of the harbors at Greytown and Brito; six will be employed upon the topographical survey and location of the route; and two will thoroughly investigate the geological features of the country traversed by the canal, by a series of borings in all the localities where cuts are proposed.

It is expected by the promoters of the enterprise that this survey will be completed by the first of next April, when the proposed final location of the canal and revised estimates of the cost of construction are to be submitted for the inspection and approval of a board composed of the most distinguished engineers of the world, including disinterested representatives of England, France, Germany, and the United States. After the route and plans for the construction of the canal have received the approval of this board of eminent engineers, the axial location will be finally determined and the work of construction will be commenced. This plan looks a little like that of the Inter-oceanic Canal Congress with which M. De Lesseps commenced his work at Panama, and we suppose the inauguration of canal building is contingent upon the subscriptions to come in for the prosecution of the enterprise. Would it not be better for the Nicaragua Canal people to buy up the partially made Panama Canal works, and finish that enterprise? It looks as if it would have to be put on sale before long, although M. De Lesseps has lately issued a bulletin saying the canal would be finished in 1890, and no more money is required for its completion. The cash they have on hand, so he gives us to understand, is sufficient.

Some of the members of the canal association think that the construction will be begun before next July, but they all express the conviction that the commencement of the work upon a scale large enough to insure its completion within six years will not be delayed beyond the 1st of November, 18-8.

**The Tunnel between France and England.**

At a recent meeting of the geological section of the British Association, a report was read on the present condition of the experimental heading for the channel tunnel between Dover and Calais, a distance of twenty-one miles, the completion of the work having been forbidden by the English government. A hole has already been bored seven feet in diameter, one mile and a quarter in length, nearly the whole of which is actually beneath the sea bottom. Most of the work was done five years ago, and as it has gone through a chalky formation needing no lining, it has remained perfectly dry and the substance at the surface of the boring has become harder by exposure to the air. On the French side, where only small progress has been made, as well as upon the English side, no serious obstacle has been found. The report says: "After taking all these facts into consideration, it was clear that the original estimate of £1,527,000 for the English half of the tunnel was amply confirmed by the experience obtained." That would give £3,054,000, say \$15,000,000, as the entire cost of the tunnel. The authors of the report go on to consider and demolish the bugbear of foreign invasion of England, which has been the reason assigned for opposition in that country to the building of the tunnel, as follows: "Water, at the rate of 100,000 cubic feet per minute, could be admitted to the tunnel through the shaft and its connecting gallery, and five or six minutes would be sufficient to render it impassable for traffic of any kind."

ENGINEERING INVENTIONS.

A car coupling has been patented by Mr. Samuel Cooley, of Flemington, N. J. The drawheads are provided with a coupling wheel and a spring-actuated link of novel construction, making a coupling wherein a link attached to each drawhead will independently couple with a revoluble pin in the opposing drawhead, the coupling working automatically.

A gas blast furnace has been patented by Mr. John H. Hillman, of Pittsburg, Pa. The invention covers a combination of a preparatory storage gas furnace, a carburization gas furnace, and a smelting gas blast furnace, each separated from the others, making a furnace adapted for the utilization of gases or solid fuel, or both combined, for smelting iron or other ores.

A railway signal has been patented by Mr. Frederick Pearce, of New York City. The invention covers a novel arrangement of circuits, track instruments, and relays, in connection with electro-magnetic signaling lanterns arranged to be operated either in open or closed circuit system by the action of a passing train, to display a danger signal during the passage of a train over the section of track protected.

Utilizing exhaust steam is the subject of a patent issued to Messrs. Robert H. F. and Nicholas H. Sewall, of Smithland, La. Combined with the engine and main boiler are a supplemental cylinder and pipes connecting it with the engine and boiler, a pivoted lever being connected with the piston in this cylinder and with the engine, a pipe extending from the pump into the pipe between the boiler and supplemental cylinder, with other novel features.

A railway tie has been patented by Mr. John H. Stull, of Okobojo, Dakota Ter. Combined with a metallic plate tie, having ears, are chairs or plates connected to the ears, and having upwardly extending lugs, with keys adapted to pass through the chairs and the ears, with other novel features, whereby the several parts shall be connected without bolts or rivets, and to which the rails may be connected by means of keys.

AGRICULTURAL INVENTIONS.

An elevator for harvesters has been patented by Mr. Milton E. Benedict, of Perry, N. Y. This invention covers a novel construction, combination, and arrangement of parts and details in a new and improved elevator for harvesters which is designed to be simple and durable in construction and very effective in operation.

A cane or corn harvester has been patented by Mr. Azro J. Shaw, of Conway, Kansas. The invention covers a novel construction and combination of parts for cutting sugar cane, corn, and similar crops, grown in rows, topping the severed stalks and discharging them to the ground at the side of the machine, which may be arranged to cut down two or more rows of the standing crop at once.

MISCELLANEOUS INVENTIONS.

A rubber back pad for harness has been patented by Mr. Ellis W. Wall, of Pishelville, Neb. It is made with a novel form of hollow air cushions, having side flanges and depressions, needing no leather covering or stuffing, while there is no danger of galling.

A pen or pencil holder has been patented by Mr. Edward E. Foster, of New York City. It consists of a spring clamp adapted to receive the end of the finger, and provided with a device for holding the pen or pencil in the position of use, thus dispensing with the usual long pen or pencil holder.

A singletree has been patented by Mr. Oscar F. Lowe, of Hampton, Iowa. This invention covers an improvement relating particularly to the construction of the clips, whereby they will be efficient in use, and the portion subjected to wear may be readily replaced when worn or otherwise useless.

A combination tool has been patented by Mr. William W. Allen, of East Pepperell, Mass. It is designed for use as a cant bar, pry bar, pinch bar, spike claw, or rail lifter, the invention covering a novel construction and arrangement of the various parts and details.

A cavity drill or reamer has been patented by Mr. John Greek, of Evansville, Ind. This invention provides a strong and durable tool, which can be easily worked to form an elliptical cavity in a bored well, which may be easily cleaned out and charged with explosives, and for other work of similar character.

A windmill has been patented by Mr. Aaron F. Chubbuck, of Tyrone, Mich. It consists essentially of a wheel carried by a vertical shaft, a shield arranged in connection with the wheel, a shield controlling mechanism, and a mechanism for imparting a uniform speed to the main shaft of the mill.

A quilting frame for sewing machines has been patented by Mr. Terelius A. Hill, of High Point, N. C. Combined with a frame or track adapted to rest on a sewing machine table, and having projecting pins, are cross legs to support each end of the track, the legs being adjustable to tables of different heights, with other novel features.

A pad for copying presses has been patented by Mr. Afton Church, of New York City. It consists of a plate provided with absorbent material on one face and with means of attachment to the follower of a copying press, whereby impressions may be taken for an indefinite period without the aid of single blotters or cloths.

A bottle and label protector has been patented by Mr. August Grisi, of Hoboken, N. J. It consists of a sheet metal body and breast pieces, formed with fastening devices or clips, by which the protector may be fastened around and made to embrace the bottle, an opening being left to reveal the print or name of the label.

A jewel case has been patented by Messrs. Solomon Valter and Lazarus Weil, of New York City. The entire body and base are preferably covered with plush, and it has an upper hinged portion forming wings which may be opened out to display articles of jewelry, there being also a lower recessed portion to receive them, with other novel features.

A sectional thatch has been patented by Mr. Robert Griswold, of Woody, Kansas. The thatching is applied to a timber frame with nails, in connection with lengths of barbed wire applied to the face of the thatching, with binding wires and longitudinal wires, making a form of thatch especially designed as a cover of ricks and stacks.

A burial vault has been patented by Mr. Herman Froehlich, of Waterloo, Ind. Combined with lower and upper parts made of plastic material to form artificial stone, and formed with inclined sides and ends and round corners, is an adjustable clamping band with handles, and other novel features, providing a cheap and durable vault to replace the common wooden box now in general use.

A horse detacher has been patented by Mr. Simon Bail, of New York City. This invention covers a novel combination of devices, more especially adapted to one-horse vehicles, capable of operation by the driver or occupant, there being combined therewith a special mechanism between the detacher and a brake, whereby the latter is thrown into action upon the wheels by the same motion of the hand lever which works the detacher.

A grip for button lathes has been patented by Mr. Will F. Young, of New York City. It is for facilitating the manufacture of vegetable ivory buttons, and made to be self-adjusting to the convex surface of the segment of ivory, whether regular or irregular, consisting of two separate grasping members, a stock to which they are pivoted, and a yoke pivoted upon the stock and connected at its ends to the lower ends of the members.

A paper cutter has been patented by Mr. John F. Meador, of Prescott, Arizona Ter. This invention provides a number of plates sliding on top of each other, and each projecting at one side a short distance beyond the corresponding side of the next following plate, being especially adapted for cutting or tearing express money orders, or other papers, where steps are left in the torn edge of the paper to indicate the amount of the value of the order.

SCIENTIFIC AMERICAN BUILDING EDITION.

NOVEMBER NUMBER.

TABLE OF CONTENTS.

1. Elegant Plate in Colors of Three Frame City Dwellings, costing Two Thousand Five Hundred Dollars each, with floor plans, sheet of details, etc.
2. Plate in Colors of a Frame Dwelling, situated at Belleville, N. J., costing Two Thousand Five Hundred Dollars, with full specifications, floor plans, sheet of details, etc.
3. Page Engraving of Holbrook Hall, New York City, an Eight Story Apartment House, lately condemned for dry rot.
4. Plans for a School House costing between Eight and Nine Thousand Dollars.
5. Half page Engraving of a Residence at Battenhall Park, Worcester, England.
6. Perspective view, with floor plans, of a Dwelling costing Four Thousand Five Hundred Dollars.
7. Drawing of a Reception Pavilion, Geneva.
8. Illustration of the New Railroad Men's House, New York. A Club House costing One Hundred Thousand Dollars.
9. Design of an Attractive Residence at Minneapolis, Minn.
10. A Church of moderate cost, with first story plain. Intended for 450 seats.
11. Engraving of a Two Story and Attic House erected at Montclair, N. J., with floor plans. Cost, Thirty-seven Hundred Dollars.
12. A Thirty-five Hundred Dollar Dwelling. Perspective and floor plans.
13. Page Engraving of the New Monument and Tomb of M. Thiers, Cemetery of Perela Chaise, Paris.
14. Design for an Entrance. Half page engraving.
15. Perspective and floor plans of a House costing Three Thousand Eight Hundred Dollars.
16. Design for a City Front. W. H. Powell, Architect, London.
17. Floor plans and perspective of a House for a narrow lot. Cost, Four Thousand Dollars.
18. Perspective and floor plans of a Four Thousand Five Hundred Dollar Residence.
19. Miscellaneous Contents: Putting Water Heating Pipes in Cook Stoves, illustrated.—Cedar Shingles.—The Trade Unions.—Some Data on Steam Heating.—Plastering.—The Humbling Sound in Closed Carriages, how prevented.—Pipes and Joints.—Jack Frost in Water Pipes.—The Effect of Freezing on Cement.—The Wood of Thuja Gigantea.—A Dutch Interior.—Spontaneous Combustion.—Cement Apparatus.—How to Repair Stone Steps.—Insulated Air Coverings for Steam, Water, and Gas Pipes, illustrated.—The New Era Radiator, illustrated.—Shingle Stains.—Effects of Snow on Marble.—"Alert" Hand Force Pump, illustrated.

The Scientific American Architects and Builders Edition is issued monthly, \$2.50 a year. Single copies, 25 cents. Forty large quarto pages, equal to about two hundred ordinary book pages; forming, practically, a large and splendid MAGAZINE OF ARCHITECTURE, richly adorned with elegant plates in colors and with fine engravings, illustrating the most interesting examples of Modern Architectural Construction and allied subjects. The Fullness, Richness, Cheapness, and Convenience of this work have won for it the LARGEST CIRCULATION of any Architectural publication in the world. Sold by all newsdealers.

MUNN & CO., PUBLISHERS, 361 Broadway, New York.

Business and Personal.

The charge for Insertion under this head is One Dollar a line for each insertion; about eight words to a line. Advertisements must be received at publication office as early as Thursday morning to appear in next issue.

Practical Working Drawings of machinery made by A. K. Mansfield & Co., 280 Broadway, N. Y. Life-long mechanics. One formerly R. R. supt. M. P. Important references. Work guaranteed. Correspondence invited.

For Sale—22 unbound volumes SCIENTIFIC AMERICAN, of old dates. Also a lot of odd numbers, in good order. For a descriptive list address L. R. Hudson, 212 East 14th St., New York.

All kinds wood engraving. Perfect; lowest rate; sell engr. tools, mate's, machs. N. H. Taylor, Wyandotte, Kan.

Portable grinding mills. Chas. Kaestner & Co., Chicago, Ill.

Engines and boilers. Chas. Kaestner & Co., Chicago, Ill.

For Sale—The following braiding machines: 2 nine carriers, 1 twelve carriers, 1 thirteen carriers, 1 sixteen carriers, 1 twenty carriers, 1 twenty-one carriers. Also three looms, 24 and 30 shuttles. All the above will be sold cheap. Raymond & Whitlock, 99 Fourth Ave., N. Y.

Wanted—New invention or novelty for the English market by a first-class London house, having a large connection among shippers, warehousemen, drapers, etc. Address "Everclean," 100 Wood St., London, England.

Lacquers.—Japan, Brilliantine, Brassoline, Opaline, and other lacquers and special varnishes. Brilliant, hard, durable. Send for catalogue. The Fred'k Cram Chemical Co., Short Hills, N. J. N. Y. agent, Horace Van Sands, 733 Broadway.

For the best and cheapest 4 Horse Engine, address Peter Walrath, Chittengo, N. Y.

Perforated metals of all kinds for all purposes. The Robert Aitchison Perforated Metal Co., Chicago, Ill.

For the latest improved diamond prospecting drills, address the M. C. Bullock Mfg. Co., 138 Jackson St., Chicago, Ill.

The Railroad Gazette, handsomely illustrated, published weekly, at 73 Broadway, New York. Specimen copies free. Send for catalogue of railroad books.

The Knowles Steam Pump Works, 113 Federal St., Boston, and 93 Liberty St., New York, have just issued a new catalogue, in which are many new and improved forms of Pumping Machinery of the single and duplex, steam and power type. This catalogue will be mailed free of charge on application.

Link Belting and Wheels. Link Belt M. Co., Chicago.

Presses & Dies. Ferracute Mach. Co., Bridgeton, N. J. Nickel Plating.—Sole manufacturers cast nickel anodes, pure nickel salts, polishing compositions, etc. \$100 "Little Wonder." A perfect Electro Plating Machine. Sole manufacturers of the new Dip Lacquer Kristaline. Complete outfit for plating, etc. Hanson, Van Winkle & Co., Newark, N. J., and 92 and 94 Liberty St., New York.

Iron Planer, Lathe, Drill, and other machine tools of modern design. New Haven Mfg. Co., New Haven, Conn.

Supplement Catalogue.—Persons in pursuit of information of any special engineering, mechanical, or scientific subject, can have catalogue of contents of the SCIENTIFIC AMERICAN SUPPLEMENT sent to them free. The SUPPLEMENT contains lengthy articles embracing the whole range of engineering, mechanics, and physical science. Address Munn & Co., Publishers, New York.

The Holly Manufacturing Co., of Lockport, N. Y., will send their pamphlet, describing water works machinery, and containing reports of tests, on application.

Curtis Pressure Regulator and Steam Trap. See p. 301.

Planing and Matching Machines. All kinds Wood Working Machinery. C. B. Rogers & Co., Norwich, Conn.

For best leather belting and lace leather, including Hercules, see Page Belting Co.'s adv., p. 318.

Iron, Steel, and Copper Drop Forgings of every description. Billings & Spencer Co., Hartford, Conn.

Paint mills. Chas. Kaestner & Co., Chicago, Ill.

Pat. Geared Scroll Chucks, with 3 pinions, sold at same prices as common chucks by Cushman Chuck Co., Hartford, Conn.

Steam Hammers, Improved Hydraulic Jacks, and Tube Expanders. R. Dudgeon, 24 Columbia St., New York.

60,000 Emerson's 1887 Book of superior saws, with Supplement, sent free to all Sawyers and Lumbermen. Address Emerson, Smith & Co., Limited, Beaver Falls, Pa., U. S. A.

Safety Elevators, steam and belt power; quick and smooth. D. Frisbie & Co., 112 Liberty St., New York.

"How to Keep Boilers Clean." Send your address for free 88 page book. Jas. C. Hotchkiss, 120 Liberty St., N. Y.

Pays well on Small Investment.—Stereopticons, Magic Lanterns, and Views illustrating every subject for public exhibitions. Lanterns for colleges, Sunday schools, and home amusements. 152 page illustrated catalogue free. McAllister, Manufacturing Optician, 49 Nassau St., N. Y.

Ax handle and spoke lathes. Railway cutting off saw machines. Rollstone Machine Co., Fitchburg, Mass.

Best belt hooks are Talcott's. Providence, R. I.

Split Pulleys at low prices, and of same strength and appearance as Whole Pulleys. Yocom & Son's Shafting Works, Drinker St., Philadelphia, Pa.

Feed grinders. Chas. Kaestner & Co., Chicago, Ill.

Send for new and complete catalogue of Scientific Books for sale by Munn & Co., 361 Broadway, N. Y. Free on application.

TO INVENTORS.

An experience of forty years, and the preparation of more than one hundred thousand applications for patents at home and abroad, enable us to understand the laws and practice on both continents, and to possess unequalled facilities for procuring patents everywhere. A synopsis of the patent laws of the United States and all foreign countries may be had on application, and persons contemplating the securing of patents, either at home or abroad, are invited to write to this office for prices, which are low, in accordance with the times and our extensive facilities for conducting the business. Address MUNN & CO., office SCIENTIFIC AMERICAN, 361 Broadway, New York.

INDEX OF INVENTIONS

For which Letters Patent of the United States were Granted

November 8, 1887,

AND EACH BEARING THAT DATE.

[See note at end of list about copies of these patents.]

Amalgamator, B. Tyson	372,723
Anchors, safety attachment for, N. Smith	372,933
Axle box, car, C. Gomer	372,906
Axle nut, C. C. Bradley	372,975
Bagasse furnace, F. Cook	372,969
Bags or satchels, combined corner protector and lock for, A. Peterson	372,762
Baling press, W. F. Denis	372,842
Baling press, W. C. Ellis	372,901
Bands, device for tightening, G. D. Frost	373,017
Battery. See Carbon battery. Galvanic battery.	
Bed, folding, K. Brooks	372,891
Bed slat fastener, L. B. Hopkins	372,913
Bedclothes fastener, A. C. Graves	372,748
Bell, electrical repeating, H. B. Cox	372,657
Belt fastener, L. Werner	372,732
Belt holder, C. Wright	372,999
Belt, link driving, J. K. Tullis	372,890
Bicycle, F. D. Randolph	373,028
Billiard table pocket, T. Dougherty	373,016
Blast furnace, gas, J. H. Hillman	372,912
Board. See Card board.	
Boiler. See Steam boiler.	
Boilers, preventing the formation of scale in steam, E. Mather	372,955
Bolt cutter, Lonnon & Mallett	372,756
Boot or shoe heel, P. Linden	372,688
Boot or shoe shank stiffener, J. M. Watson	372,728
Bottle for blacking, mucilage, etc., H. A. Bartlett	372,737
Bottle packing, C. B. Heston	373,019
Bottle stopper cover, T. C. Bunting	372,892
Box. See Axle box.	
Box joint, L. F. Mergott	372,694
Bracket. See Kitchen bracket.	
Brake. See Car brake. Wagon brake.	
Brake saddle and shoe, L. P. Lawrence	372,810
Brick moulds, machine for sanding, A. C. Newton et al.	372,636
Broom holder, whisk, J. Wright	372,885
Buckle, F. B. Spooner	372,821
Burner. See Gas burner. Lamp burner.	
Bustle, Hubbard & Williamson	372,800 to 372,802
Button setting machine, O. Stoddard	372,773
Buttons, machine for making collar, G. Kremenz	372,683
Cabinet, grocer's, J. P. Flick	372,972
Cables, splicing traction, P. J. Franzse	372,792
Camera. See Photographic camera.	
Camera plate holder, M. P. Warner	372,773
Can filling machine, H. R. Stickney, 2d	372,876
Candy furnace and oven combined, E. C. Frost	372,653
Car brake, G. A. Boyden	372,890
Car brakes, operating, G. A. Boyden	373,005
Car conduit, underground cable, D. Hagerty	372,749
Car coupling, S. Byrne	372,893
Car coupling, S. Cooley	372,886
Car coupling, J. Haish	372,906
Car coupling, A. W. Hughey	372,979
Car coupling, R. W. Hunter	372,980
Car coupling, A. H. Reynolds	372,705
Car coupling, J. H. Wiseman	373,040
Car heater, H. G. Wilson	372,779
Car heater and ventilator, T. Saunders	372,989
Car wheel, J. A. Parker	372,771
Cars, bull's eye or signal for street, J. A. Brill	372,959
Cars, cupola for freight, C. A. Smith	372,937
Cars, heating pipe connection between, W. L. Sr., & W. L. Van Hartinzen, Jr.	372,946, 372,947
Cars, method of and apparatus for heating railway, F. M. Wilder	373,089
Bars, etc., track cleaning attachment for street, Peper & Sobinski	372,816
Carbon battery, C. H. Wilder	372,734
Card board, H. B. Dexter	372,971
Carding machine, Senior & Fitton	372,771
Carriage door, J. F. Fallon	372,847
Carriage top, W. M. Ward	372,949
Carriage top irons, machine for rolling, F. Schreidt	372,711
Carriage top operating device, W. M. Ward	372,948
Cart, road, O. W. Numbree	372,925
Cartridge, H. P. Hursh	372,678
Case. See Medicine case. Watch case.	
Centering device, H. P. Wellman	372,730
Chain hook, watch, H. M. Herring	372,675
Chuck, planer, E. Shaw	372,714
Churn, H. Heitkamp	372,751
Churn lid clamp, L. K. Koontz	372,858
Cider press, lever, J. E. Horstick	372,914
Cigar or cigarette, medicated, J. M. Allan	372,782
Clamp. See Churn lid clamp. Cotton press clamp. Jar clamp.	
Clock, J. Zelly	372,780
Clocks, chiming apparatus for, J. Harrington	372,849
Cloth cutting machine, F. W. Nevens	372,925
Clothes drier, H. F. Bolton	373,004
Clothes line prop, J. S. Jameson	372,915
Clothes rack attachment, F. W. Weis	372,863
Concentrating machine, F. E. Monteverde	373,026
Concentrator, W. L. Card	372,741
Connecting rod, D. H. Dugar	372,843
Converter box, G. Westinghouse, Jr., et al.	373,048
Conveyer, screw, J. S. Wilson	372,950
Coop, chicken, B. P. Cobb	372,366
Corn cutting machine, G. B. Dean (r)	10,880
Corrugating machines, attachment for, G. C. Keene	372,916
Cotton press clamp, W. F. Moss	372,692
Cotton stalk cutter, J. P. Lockwood	372,858
Coupling. See Car coupling. Pipe coupling. Whiffletree coupling.	
Crate, C. R. Swan	372,992
Crushing or pulverizing mill, W. L. Card	372,742
Cuff fastener, T. E. Barrow	372,887
Current generators, method of and apparatus for connecting alternate, O. B. Shallenberger	372,934
Curtain pole ring, T. Morris	372,815
Cutter. See Bolt cutter. Cotton stalk cutter.	
Delivery mouth, controllable, B. K. Dorwart	372,899
Demijohn, etc., F. A. & D. Bahr	372,951
Die stock, H. E. Galloway	372,864
Digger. See Potato digger.	
Door check, C. M. Cashin	372,655
Door fastening, G. Van Wagenen	372,829, 372,830
Draught equalizer, M. P. Lomen	372,859
Drawer pull, F. H. Chilton	373,013
Dress forms, making, M. W. Henlus	372,909
Drier. See Cloth drier.	

Electric converter, O. B. Shallenberger..... 373,029  
 Electric currents, resistance regulator for, G. Montanus..... 372,960  
 Electric distribution, pressure indicating apparatus and circuit for a system of, O. B. Shallenberger..... 372,986  
 Electric generators, apparatus for connecting alternate current, O. B. Shallenberger..... 372,935  
 Electric machine, dynamo, F. J. Sprague..... 372,922  
 Electric machine, dynamo, W. Stanley, Jr..... 372,945  
 Electric machinery, dynamo, H. E. Walter..... 373,084  
 Electric meter, H. M. Byllesby..... 373,010  
 Electric motor, D. Higham..... 372,910  
 Electric motor, F. J. Sprague..... 372,823  
 Electrical current indicator, J. F. Kelly..... 372,851  
 Electrical distribution, J. W. Howell..... 372,797  
 Electrical distribution and conversion, W. Stanley, Jr..... 372,944  
 Electrical distribution and conversion, system of, W. Stanley, Jr..... 372,943  
 Electrical distribution, automatic circuit controlling apparatus for systems of, G. Westinghouse, Jr..... 373,086  
 Electrical distribution, system of, H. M. Byllesby..... 373,009  
 Electrical distribution, system of, G. Westinghouse, Jr..... 373,037  
 Electrical regulation, system of, W. Stanley, Jr..... 372,942  
 Electro-therapeutic apparatus, F. J. Kneuper..... 372,808  
 Elevator. See Harvester elevator.  
 Elevator safety hatch, E. L. Cole..... 372,744  
 Embroidery frame, J. Sanders..... 372,707  
 Enamel, coating wood, paper, etc., with impervious, J. A. Pond..... 372,927  
 Enamelled surface for carriages and the like, M. B. Church..... 373,014  
 End gate, wagon, J. Stone..... 372,991  
 Engine. See Pumping engine.  
 Envelope, letter sheet, G. P. Herndon..... 372,752  
 Eraser, blackboard, J. Travis..... 373,032  
 Excavator, A. B. Bowers..... 372,956  
 Eyelet setting machine, E. B. Stimpson, Jr..... 372,826  
 Farm gate, M. H. Newville..... 372,700  
 Fence, S. F. Morrow et al..... 372,924  
 Fence machine, C. E. Anderson..... 372,850  
 File, letter and bill, J. M. Kelly..... 372,983  
 Firearm, breech-loading, D. M. Lefever..... 372,684  
 Fire chamber, E. J. Story..... 372,774  
 Fire escape, O. S. Judd..... 372,982  
 Fire extinguisher, automatic, J. Hill..... 372,977  
 Fire works safe, T. Lloyd..... 372,811  
 Fish hook attachment, M. Lester..... 372,686  
 Fish plate, H. F. Cox..... 372,659  
 Fishing hook and line, F. Hubbard..... 372,677  
 Folding seat or chair, A. H. Underwood..... 372,881  
 Foundry patterns, making, H. A. Garvey..... 372,798  
 Frame. See Embroidery frame. Sewing machine quilting frame.  
 Furnace. See Bagasse furnace. Blast furnace. Candy furnace. Gas furnace. Heating furnace.  
 Furnace, C. H. Bicalky..... 372,738  
 Furnace, R. Steel..... 373,030  
 Fuse for projectiles, A. Noble..... 372,814  
 Fuse or firing mechanism for projectiles, A. Noble..... 372,699  
 Gauge. See Water gauge.  
 Galley support, reversible, C. C. Blakeley..... 372,955  
 Galvanic battery, H. B. Cox..... 372,658  
 Galvanic battery, J. W. Howell..... 373,021  
 Garment stretcher, D. P. Mullins..... 373,027  
 Gas burner, incandescent, J. S. Sellon..... 372,983  
 Gas burners, safety lock for, Drinkhouse & Ziesche..... 372,789  
 Gas cut-off, automatic, A. Bryce..... 372,900  
 Gas furnace, C. V. Henry..... 373,018  
 Gas generating apparatus, Isbell & Taylor..... 372,808  
 Gas meter, H. J. Bell..... 373,003  
 Gas meters, price indicator and pressure regulator for, R. A. Potter..... 372,928  
 Gases, method of and apparatus for mingling, A. C. Lewis..... 372,687  
 Gate. See End gate. Farm gate.  
 Grain cradle attachment, T. C. Fisher..... 372,791  
 Gramophone, E. Berliner..... 372,786  
 Griddle greaser, M. L. W. Adams..... 372,648  
 Grinding mill, S. P. Walling..... 372,736  
 Guns and shells, electric firing mechanism for, Bradley & Rolroyd..... 372,958  
 Handcuff, D. C. Alden..... 372,896  
 Handle for chests, trunks, etc., J. W. Doty..... 372,900  
 Harness back pad, rubber, E. W. Wall..... 372,882  
 Harrow and roller, combined, E. H. Neff..... 372,759  
 Harrow, sulky, W. R. Archer..... 372,651  
 Harvester, cane or corn, A. J. Shaw..... 372,870  
 Harvester, cotton, W. L. Langley..... 372,918  
 Harvester elevator, M. E. Benedict..... 372,889  
 Harvesters, picker stem for cotton, W. L. Langley..... 372,919  
 Hay carrier counterbalance, J. Meggers..... 372,683  
 Hay rake and gatherer, J. Allen..... 372,783  
 Heater. See Car heater.  
 Heating furnace, E. C. Condit..... 372,968  
 Heel protector, E. Kempshall..... 372,807  
 Hoisting machine, J. B. Hurd..... 373,022  
 Hoisting machine, W. Hart..... 372,908  
 Hoisting mechanism, differential, G. F. Clemons..... 372,839  
 Holder. See Belt holder. Broomholder. Camera plate holder. Pen and pencil holder. Sash holder. Spool holder. Thill holder.  
 Hook. See Chain hook. Fishing hook. Snap hook.  
 Horse detacher, J. M. Fiedler..... 372,902  
 Horse grooming device, J. O. Wells..... 372,731  
 Horseshoe, sectional, E. W. Bingham..... 372,682  
 Horseshoes, packing holder for, W. J. Follett..... 372,682  
 Hot houses, device for operating the ventilating frames of, W. H. Diven..... 372,746  
 Indicator. See Electrical current indicator. Speed indicator.  
 Insulating joint, Soden & Goehst..... 372,940  
 Iron. See Carriage top iron. Tuyere iron.  
 Jar clamp, H. H. Davidson..... 372,897  
 Joint. See Box joint. Insulating joint. Miter or level joint.  
 Kitchen bracket, F. Aldrich..... 373,002  
 Knife for cutting barrel staves, W. E. Woodrow..... 372,998  
 Lace clipping or cutting apparatus, H. Duden..... 372,661  
 Lacing loop, A. H. Pratt..... 372,704  
 Ladder, step, C. S. Comins..... 372,967  
 Lamp burner, W. N. Daniels..... 372,745  
 Lamp regulator, electric, S. Mathis..... 372,986  
 Land roller, B. R. Lyddon..... 372,984  
 Latch, W. Noelte..... 372,815  
 Latch, Stone & Cote..... 372,878  
 Latch and lock, combined, Budd & Sickels..... 372,961  
 Lathing, wire, C. A. Sackett..... 372,819  
 Letter sheet and envelope, combined, H. D. Lefevre..... 372,685  
 Level, spirit, C. B. Long..... 372,921  
 Lifter. See Pan lifter.

Liniment, J. W. Still..... 372,825  
 Liquid separator, centrifugal, G. De Laval..... 372,788  
 Lock. See Nut lock. Seal lock. Trap lock.  
 Lock and latch, combined, Budd & Sickels..... 372,962  
 Loom shedding mechanism, J. T. Cree..... 372,840  
 Loom, terry, F. Leake..... 372,920  
 Lubricator, J. Powell..... 372,764  
 Lubricator, J. C. Schellenbaum..... 372,708  
 Lubricator, A. Warth..... 372,997  
 Measuring cloth in bolts, apparatus for, A. B. Cross..... 372,660  
 Medicine case, physician's, Marquis & Hahn..... 372,812  
 Medicine, cough remedy, D. Basch..... 372,952  
 Metal grinding machine, A. A. Weimer..... 372,833  
 Metal shears, W. J. Bayrer..... 372,784  
 Meter. See Electric meter. Gas meter.  
 Mill. See Crushing or pulverizing mill. Grinding mill. Rolling mill.  
 Missile protector, spring, W. M. Jackson..... 372,961  
 Miter or bevel joint, C. M. Merritt..... 372,695  
 Moulding articles under pressure from plastic materials, J. Naylor..... 372,758  
 Motor. See Electric motor.  
 Musical instrument wind, A. V. Chevers..... 373,012  
 Nail. See Wire nail.  
 Nut lock, J. C. Blakney..... 372,789  
 Octave coupler, J. A. Warren..... 372,727  
 Oil, refining hydrocarbon, T. G. Hall..... 372,812  
 Ointment, H. V. Knaggs..... 372,852  
 Organ key boards, applying celluloid to, W. C. Zeidler..... 373,001  
 Organ octave coupler, J. A. Smith..... 372,772  
 Organ stop knob, R. Alden..... 372,649  
 Pad. See Harness back pad. Stair pad.  
 Pamphlet cover presser, E. F. Price..... 372,765  
 Pan lifter and turner, A. M. Burnham..... 372,968  
 Paper, preservative, J. T. & H. W. Morgan..... 372,861  
 Paper, sheathing, W. H. H. Childs..... 372,894  
 Pedal, R. W. Tanner..... 372,776  
 Pen or pencil holder, E. E. Forster..... 372,903  
 Pencil, T. O. L. Schrader..... 372,710  
 Pessary, automatic stem, A. O. McCord..... 372,922  
 Photographic camera, W. H. Lewis..... 372,856  
 Photographic cameras, shutter for, W. H. Lewis..... 372,857  
 Pictures, making electric gold, A. W. & E. M. Tucker..... 372,720  
 Pigments from galena, etc., manufacturing, F. P. Dewey..... 372,898  
 Pillow, A. Poitevent..... 372,763  
 Pipe. See Tobacco pipe.  
 Pipe coupling, L. Etienne..... 372,790  
 Pipes, service box for water or gas, S. J. Ketcham..... 372,680  
 Planter, corn, H. J. Wagner..... 372,725  
 Planter, cotton, T. C. Garlington..... 372,665  
 Planters, attachment for corn, M. A. Griner..... 372,671  
 Plastering, wire foundation for, C. A. Sackett..... 372,816  
 Plow, gang, F. F. Landis..... 372,854  
 Plow, side hill sulky, Wiard & Bullock..... 372,884  
 Plows, lever scraper for cleaning, A. W. Tucker..... 372,719  
 Potato digger, J. Lundergan..... 372,757  
 Press. See Baling press. Cider press. Printing press.  
 Press and a folder, sheet associating mechanism between a, C. Kahler..... 373,024  
 Printing and delivery apparatus, web, S. D. Tucker..... 372,721  
 Printing machine, color, C. R. Taylor..... 372,777  
 Printing machine, rotary, C. Kahler..... 373,023  
 Printing machine, rotary, W. Scott..... 372,712  
 Printing press, J. Thomson..... 372,968  
 Protector. See Heel protector.  
 Pulp engines, beater roll for, J. Hoyt..... 372,978  
 Pump, force, R. Bean..... 372,888  
 Pump, submerged force, V. W. Beeson..... 372,953  
 Pumps, sucker rod for, D. Jones..... 372,804  
 Pumping apparatus, electrical, F. J. Sprague..... 372,824  
 Pumping engine, H. F. Gaskill..... 372,794  
 Pyroxyline, solvent for, O. P. Amend (r)..... 10,879  
 Railway, cable, C. Pepper..... 372,866  
 Railway, signal, F. Pearce..... 372,865  
 Railway switch, R. B. Short..... 372,715  
 Railway tie, J. H. Stull..... 372,879  
 Railway tie, metallic, C. Netter..... 372,864  
 Railways, cable lifter for cable, J. H. Robertson..... 372,980  
 Railways, permanent way for, I. A. Perry..... 372,703  
 Rake. See Hay rake.  
 Ratchet wrench, L. Bryant..... 372,654  
 Regulator. See Lamp regulator.  
 Ring. See Curtain pole ring.  
 Rod. See Connecting rod.  
 Roller. See Land roller.  
 Roller mills, feed regulator for, O. Smith..... 372,989  
 Rolling mill, reversing, J. Q. Everson..... 372,747  
 Roofing, cleat for metal, L. L. Sagendorph..... 372,931  
 Roofing plate, sheet metal, C. B. Cooper..... 372,787  
 Ropes, device for holding and splicing, I. B. Davies..... 372,970  
 Rule, lumber, S. C. Hamilton, Jr..... 372,673  
 Sash holder, R. L. Stopfer..... 372,827  
 Saw filing machine, E. J. Richmond..... 372,766  
 Saw hammering machine, W. Gowen..... 372,697  
 Saw, marble or granite, E. W. Kent..... 372,679  
 Sawmills, roller gauge for, S. G. Lang..... 372,809  
 Sawing machine, band, J. R. Thomas..... 373,081  
 Sawing machine, circular, C. F. Gerlach..... 372,904  
 Scissors sharpener, I. A. Abbot..... 372,886  
 Scraper, W. Haslup..... 372,795  
 Scraper, road, H. Wiard et al..... 372,885  
 Screen. See Velocipede screen.  
 Seal, E. J. Brooks..... 373,007  
 Seal lock, C. V. Boughton..... 372,653  
 Seam pressing machine, Busfield & Fellows..... 372,837  
 Seaming machine, double, V. Crockett..... 372,896  
 Seat. See Folding seat.  
 Seat fastener, C. W. Needles..... 372,697  
 Seeder, J. Carson..... 372,748  
 Seeding boot and attachments, J. F. Keller..... 372,755  
 Separator. See Liquid separator.  
 Sewage, separating and filtrating apparatus for, C. W. Chancellor..... 372,656  
 Sewing machine, buttonhole, F. E. Schmidt..... 372,709  
 Sewing machine quilting frame, T. A. Hill..... 372,911  
 Shears. See Metal shears.  
 Sheet metal shearing machine, C. Wals..... 373,093  
 Shell, H. P. Hurst..... 372,758  
 Shirt, G. H. Abrams..... 372,781  
 Signal. See Railway signal.  
 Singletree, O. F. Lowe..... 373,025  
 Slasher, C. McCarty..... 372,692  
 Sled, W. Haslup..... 372,974  
 Sled, bob, J. S. Nelson..... 372,863  
 Snap hook, C. A. Pomeroy..... 372,817  
 Soldering machine, can, C. W. Sleeper..... 372,871  
 Spectacle temple, R. Bradley, Jr..... 373,006  
 Spectacles, C. B. Bishop..... 372,954  
 Speed indicator and register, C. Sperry..... 372,875  
 Speed indicator for vessels, C. Sperry..... 372,874  
 Spinning spindles, bearing for, J. W. Wattles..... 372,729  
 Spinning spindles, support for, W. T. Carroll..... 372,538  
 Spool holder, G. Lander..... 372,917  
 Spring. See Vehicle spring.

Stair pad, T. S. Sperry..... 372,941  
 Stalk knocker, W. A. Allen..... 372,735  
 Stand. See Switch stand.  
 Steam boiler, F. F. Landis..... 372,855  
 Steam, utilizing exhaust, R. H. F. & N. H. Sewall..... 372,713  
 Steel, welding, W. B. Middleton..... 372,686  
 Steering apparatus, steam, L. W. & N. Lombard..... 372,691  
 Stone sawing machine, G. M. Viernow..... 372,968  
 Stool for stores, counter, J. Danner..... 372,841  
 Storage warehouse and storing materials, P. G. Hubert..... 372,850  
 Stove, G. Van Wagenen..... 372,831  
 Stove for heating cars, etc., G. Van Wagenen..... 372,828  
 Stove for heating cars, boats, etc., G. Van Wagenen..... 372,832  
 Stove, vapor, Ruppel & Dandler..... 372,832  
 Stoves, burner for vapor, W. Vogel..... 372,724  
 Suspender end, F. B. Spooner..... 372,820  
 Switch. See Railway switch.  
 Switch stand, F. W. Snow..... 372,716  
 Telegraphic transmitter, W. W. Evans..... 372,846  
 Telegraphic transmitter, G. Juengst..... 372,806  
 Thill holder, C. H. & G. D. Sampson..... 372,770  
 Thread twisting machine, J. J. & J. A. O'Connor..... 372,700  
 Tie. See Railway tie.  
 Tobacco pipe and manufacturing the same, A. Ruth..... 372,769  
 Tongue support, T. E. Burlingame..... 372,740  
 Tool, combined, J. E. Schwallier..... 372,932  
 Toy pistol, Shepard & Adams..... 372,990  
 Trap lock, J. F. Mehren..... 372,933  
 Trap lock, J. F. Wollensak..... 372,894  
 Truck for handling pipe, O. Hellman..... 372,976  
 Tube expander, Verbeck & De Raet..... 372,965  
 Tug, shaft, S. E. Harsh..... 372,973  
 Turning irregular forms, machine for, W. Hoopes..... 372,796  
 Turning irregular forms, machine for, C. Kehr..... 372,806  
 Tuyere iron, B. Lister..... 372,689  
 Valve, J. & A. Zehren..... 373,000  
 Valve gear, H. T. Giles..... 372,666  
 Vehicle cramping check, W. J. Perkins..... 372,702  
 Vehicle spring, H. C. Swan..... 372,717  
 Vehicle, spring, H. P. Tefft..... 372,718  
 Vehicle, two-wheeled, B. J. Healy..... 372,674  
 Vehicle, two-wheeled, H. G. M. Howard..... 372,676  
 Velocipede saddle, C. H. Veeder..... 372,994  
 Velocipede screen, E. Ames..... 372,736  
 Vessel for harbor and coast defense, F. I. Palmer..... 372,751  
 Vessels, composition for lining, C. H. Wilder..... 372,738  
 Wagon body, J. Stumpf..... 372,775  
 Wagon brake, W. S. Smith..... 372,878  
 Wagon brake, automatic, O. Kirlin..... 372,682  
 Wagon running gear, M. C. Hall..... 372,907  
 Washing machine, I. B. Stillman..... 372,877  
 Watch, A. O. Jennings..... 372,754  
 Watch case, E. C. Chappatte..... 373,011  
 Watch pendant, W. S. Richardson..... 372,868  
 Water closet valve and reservoir, W. B. Cooper..... 373,015  
 Water closets, flushing apparatus for siphon, D. D. Buick..... 372,964  
 Water gauge, safety, J. Graham..... 372,848  
 Water mains, machine for tapping, A. & E. Raffour..... 372,929  
 Wells and devices connected therewith for actuating water wheels, arrangement of artesian, L. Lohman..... 372,630  
 Wheel. See Car wheel.  
 Whiffletree coupling, M. B. Kirker..... 372,681  
 Whiffletree coupling, M. B. Runyan..... 372,988  
 Wick, J. F. Seery..... 372,869  
 Window, A. Hitt..... 373,020  
 Wire nail, barbed and corrugated, Emerson & Midgley..... 372,844  
 Wire nails, gripping die for corrugating and barbing, Emerson & Midgley..... 372,845  
 Wire tightening device, J. Vivian..... 372,723  
 Wool, process of and apparatus for cleaning and scouring, C. Robeson..... 372,987  
 Wrench. See Ratchet wrench.  
 Wrench, C. W. Hale..... 372,750  
 Yarn in cops, apparatus for dyeing, scouring, and bleaching, A. Graemiger..... 372,736  
 Yarn in cops, apparatus for dyeing, scouring, bleaching, and otherwise treating, H. Richmond..... 372,767

Tobacco, cut and dried or long-cut smoking and chewing, G. W. Gail & Ax..... 14,902  
 Tobacco, granulated smoking, G. W. Gail & Ax..... 14,903  
 Tonic beverage, P. Best Brewing Company..... 14,896  
 Vermifuge, S. Mansfield & Co..... 14,911  
 Wood fiber, hollow ware moulded in one piece from, Union Indurated Fiber Company..... 14,921  
 Woolen undergarments, Dr. Jaeger's Sanitary Woolen System Company..... 14,908  
 Yeast powders, H. R. Gogreve..... 14,905

A printed copy of the specification and drawing of any patent in the foregoing list, also of any patent issued since 1866, will be furnished from this office for 25 cents. In ordering please state the number and date of the patent desired, and remit to Munn & Co., 361 Broadway, New York. We also furnish copies of patents granted prior to 1866; but at increased cost, as the specifications, not being printed, must be typed by hand.

Canadian Patents may now be obtained by the inventors for any of the inventions named in the foregoing list, provided they are simple, at a cost of \$40 each. If complicated the cost will be a little more. For full instructions address Munn & Co., 361 Broadway, New York. Other foreign patents may also be obtained.

Advertisements.

Inside Page, each insertion - - - 75 cents a line. Back Page, each insertion - - - \$1.00 a line. The above are charges per agate line—about eight words per line. This notice shows the width of the line, and is not in agate type. Engravings may head advertisements at the same rate per agate line, by measurement, as the letter press. Advertisements must be received at publication office as early as Thursday morning to appear in next issue.

**SEBASTIAN, MAY & CO'S**  
 Improved Screw Cutting  
**LATHES** Foot & Power \$60.  
 Drill Presses, Chucks, Drills, Dogs, and machinists' and amateurs' outfits, Lathes on trial. Catalogues mailed on application  
 165 W. 2d St., Cincinnati, O.

**THE IRON AND COAL DISTRICTS** of Alabama—An interesting paper, with map showing the position of the mineral districts of the State. Contained in SCIENTIFIC AMERICAN SUPPLEMENT, No. 500. Price 10 cents. To be had at this office and from all newsdealers.

**COMPETITION.**  
**SCHOOL HOUSES.**  
 [At Albany, N. Y.] STATE OF NEW YORK. DEPARTMENT OF PUBLIC INSTRUCTION, SUPERINTENDENT'S OFFICE. ALBANY, N. Y., September 20, 1887. Plans and specifications for school houses. Architects are invited to submit competition plans for six school buildings, for which \$975 is offered in prizes. Time of competition limited to December 15, 1887. For further particulars address A. S. DRAPER, 619 State Superintendent, Albany, N. Y.

**SEVERN AND MERSEY TUNNELS.**—Full description of these two important engineering works, with two engravings. Contained in SCIENTIFIC AMERICAN SUPPLEMENT, No. 604. Price 10 cents. To be had at this office and from all newsdealers.

**SCIENTIFIC BOOK CATALOGUE,** RECENTLY PUBLISHED. Our new catalogue containing over 100 pages, including works on more than fifty different subjects. Will be mailed free to any address on application. MUNN & CO., Publishers Scientific American, 361 Broadway, New York.

**DIPHTHERIA—A PAPER BY DR. Carl Bunsen,** giving the results of his microscopic researches into the cause, origin and propagation of this dread disease. With 9 figures. Contained in SCIENTIFIC AMERICAN SUPPLEMENT, No. 607. Price 10 cents. To be had at this office and from all newsdealers.

**2d HAND MACHINERY** Lists sent. N.Y. Machinery Depot, Bridge Street No. 16, Frankfort Street, N. Y.

**TELESCOPIC OBJECTIVES AND MIRRORS.** Their preparation and testing.—By H. Grubb, F. R. S. An interesting description of the processes now employed in the construction of telescopic objectives, prefaced with a short history of the manufacture of glass. Contained in SCIENTIFIC AMERICAN SUPPLEMENTS, Nos. 548 and 549. Price, 10 cents each. To be obtained at this office or from any newsdealer.

**ARTESIAN**  
 Wells, Oil and Gas Wells, drilled by contract to any depth, from 50 to 3000 feet. We also manufacture and furnish everything required to drill and complete same. Portable Horse Power and Mounted Steam Drilling Machines for 100 to 600 ft. Send 6 cents for illustrated catalogue.  
**Pierce Well Excavator Co.** New York.

**AMMONIA SULPHATE—A PAPER** by Watson Smith, F.C.S., describing Grunberg's apparatus and process for making sulphate of ammonia. With 3 figures. Contained in SCIENTIFIC AMERICAN SUPPLEMENT, No. 516. Price 10 cents. To be had at this office and from all newsdealers.

**Syracuse Malleable Iron Works**

**TANNIN, ITS PRESENT AND FUTURE** Sources.—A lecture by Prof. Henry Trimble, giving a very comprehensive treatment of the subject. Contained in SCIENTIFIC AMERICAN SUPPLEMENT, No. 602. Price 10 cents. To be had at this office and from all newsdealers.

FAC-SIMILE copies obtained to an unlimited extent in indelible black by the copying apparatus, equal to the finest lithographic work. Specimens free.  
**ECLIPSE**  
 FELIX F. DAUS & CO., 21 Beekman Street, New York.

**PHOTO-ENGRAVING PROCESSES.**—The "Washout" process. The swelled gelatine process. Full details of each. Contained in SCIENTIFIC AMERICAN SUPPLEMENT, No. 612. Price 10 cents. To be had at this office and from all newsdealers.

**THE ONLY PRACTICAL ELECTRIC MOTORS** FOR FAMILY SEWING MACHINES. THE ELECTRO-DYNAMO CO PHILA 224 CARTER ST PHILADEL, PA

**WE MANUFACTURE WELL DRILLS**  
FOR Water, Coal and Gas,  
Hydraulic or Jetting.  
Largest Stock in America.  
Farmers with small outlay (experience unnecessary), can make large profits. No risks. Can direct buyers to paying territory.  
Prospecting for Water, Coal or Gas done on application.  
Also M's of WIND MILLS, HORSE POWERS, FEED MILLS, FODDER AND ENSILAGE CUTTERS, PUMPS AND WELL SUPPLIES. Mention this Paper. Send 14c. to cover cost mailing Catalogue.



CHICAGO TUBULAR WELL WORKS,  
68 W. Lake St., Chicago, Ill.

**MACHINERY PALACE OF THE PARIS**  
Exhibition of 1889.—Description of the main gallery of the machinery Palace, and of the 362 1/2 foot trusses which are to be used in its construction. With 2 engravings. Contained in SCIENTIFIC AMERICAN SUPPLEMENT, No. 594. Price 10 cents. To be had at this office and from all newsdealers.

**Contractors and Builders, Cabinet Makers, and Metal Workers,** by using outfits of **BARNES' PATENT FOOT-POWER MACHINERY.**  
Can bid lower and save more money from their jobs than by any other means for doing their work. Also for industrial training in schools and homes. With them, practical journeyman's trades can be acquired. Catalogue free. Address  
**W. F. & JOHN BARNES CO.**  
1999 Ruby St., Rockford, Ill.



**PHTHISIS.—A PAPER BY DR. H. C. WOOD,** describing in detail the new treatment of consumption by sulphureted hydrogen. Contained in SCIENTIFIC AMERICAN SUPPLEMENT, No. 594. Price 10 cents. To be had at this office and from all newsdealers.

**CLARK'S NOISELESS RUBBER WHEELS**  
No more Splintered Floors.  
Different Styles. Catalogue Free.  
**GEO. P. CLARK,**  
Box L. Windsor Locks, Ct.



**SUNLIGHT COLORS.—A PAPER BY Capt. W. De W. Abney,** explaining the cause of the red appearance of the sun in a fog. With 2 illustrations. Contained in SCIENTIFIC AMERICAN SUPPLEMENT, No. 593. Price 10 cents. To be had at this office and from all newsdealers.

**CARY & MOEN**  
STEEL WIRE OF EVERY DESCRIPTION  
234 W. 29 ST. NEW YORK CITY



**ELECTROTECHNICS, DEFINITIONS and Designations in.—A list of the symbols proposed by Mr. Jamieson for electrical units, magnitudes, and electric measurements. With 4 figures. Contained in SCIENTIFIC AMERICAN SUPPLEMENT, No. 595. Price 10 cents. To be had at this office and from all newsdealers.**

**The Draper Recording Thermometer.**

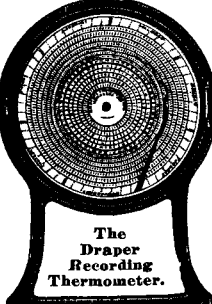

This thermometer gives a permanent and continuous record in ink of the temperature. The chart indicating hours of the day and days of the week gives the degrees of temperature from 20° below zero to 110° above. All instruments are accurately adjusted and warranted. The record is easily read and absolutely correct. Sold by the leading instrument dealers and opticians throughout the United States and Canada, and by  
**The DRAPER MANUFACTURING CO.**  
Owners of the United States and foreign patents,  
152 Front Street, New York  
Size 14x20 in. Patented. Copyrighted.

**RADII OF CURVATURE GEOMETRICALLY CONSIDERED.—By Prof. C. W. MacCord.** A paper treating of the path of a point on a connecting rod. With 3 figures. Contained in SCIENTIFIC AMERICAN SUPPLEMENT, No. 593. Price 10 cents. To be had at this office and from all newsdealers.

**SHIELDS & BROWN CO**  
Manufacturers of Sectional  
**INSULATED AIR COVERINGS**  
FOR  
Steam, Gas and Water Pipes, Drums, Heaters, etc.  
The Best Non-Conductor of Heat & Cold in the World.  
Send for illustrated descriptive Circular, and name this paper.  
143 Worth Street, NEW YORK. 78 and 80 Lake St., CHICAGO.



**TRAMWAY, FLEXIBLE GIRDER.—Description of an improved system of constructing a modification of the well known and extensively used rope or wire tramway. With 21 figures. Contained in SCIENTIFIC AMERICAN SUPPLEMENT, No. 595. Price 10 cents. To be had at this office and from all newsdealers.**

**WE SELL DIRECT TO FAMILIES—(avoid Agents and Dealers whose profits and expenses double the cost on every Piano they sell) and send this First-Class UPRIGHT Cabinet GEM 7 1/2 Octave Rosewood Piano, Warranted 8 years, for \$193! We send it with Beautiful Cover and Stool—for Trial in your own Home before you buy. Send for circular to  
**Marchal & Smith, 235 East 21st St., N. Y.****



**PERFECT NEWSPAPER FILE**  
The Koch Patent File, for preserving newspapers, magazines, and pamphlets, has been recently improved and price reduced. Subscribers to the SCIENTIFIC AMERICAN and SCIENTIFIC AMERICAN SUPPLEMENT can be supplied for the low price of \$1.50 by mail, or \$1.25 at the office of this paper. Heavy board sides; inscription "SCIENTIFIC AMERICAN" in gilt. Necessary for every one who wishes to preserve the paper.  
Address  
**MUNN & CO.,**  
Publishers SCIENTIFIC AMERICAN.

**CONSUMPTION** throat and bronchial troubles cured. A late discovery. Sample bottles free with treatise containing directions for home treatment. Give express office.  
**DR. WM. F. G. NOETTLING & CO.,** East Hampton, Conn.

**ASBESTOS PIPE COVERINGS**  
Made entirely of ASBESTOS.  
Absolutely Fire Proof.  
BRAIDED PACKING, MILL BOARD, SHEATHING, CEMENT, FIBRE AND SPECIALTIES.  
**CHALMERS-SPENCE CO.,** FOOT E. 8TH ST., N. Y.  
BRANCHES: Phila, 34 S. 2d St. Chicago, 144-146 E. Lake St. Pittsburg, 37 Lewis Block.



**TABASHEER, RELATION OF TO MINERAL Substances.—An account of a curious substance secreted by the bamboo. Its physical properties and chemical composition, and its appearance under the microscope. With one figure. Contained in SCIENTIFIC AMERICAN SUPPLEMENT, No. 595. Price 10 cents. To be had at this office and from all newsdealers.**

**LATHES For Cutting Irregular Forms**  
Such as Axe Handles, etc., A Specialty.  
Barrel Hoop and Basket Machines, Veneer Cutting Machines, Handle and Nulling Lathes, Milling, Mortising, Gear, and Key Seat Cutting Machines, Stave, Heading, and Shingle Machines.  
MANUFACTURED BY THE  
**I. E. HERBERT MACHY CO.,** Lockport, N. Y., U. S. A.



**LIGHTNING CONDUCTORS.—DESCRIPTION of a new form of apparatus for testing lightning conductors, and the method of using it. Illustrated with 8 engravings. Contained in SCIENTIFIC AMERICAN SUPPLEMENT, No. 596. Price 10 cents. To be had at this office and from all newsdealers.**

**TIGHT & SLACK BARREL MACHINERY**  
A SPECIALTY  
**JOHN GREENWOOD & CO.**  
ROCHESTER N. Y.



**GOING INTO THE POULTRY BUSINESS.—A paper by P. H. Jacobs,** reviewing the commercial aspects of poultry raising, and giving many useful hints upon the subject. Contained in SCIENTIFIC AMERICAN SUPPLEMENT, No. 596. Price 10 cents. To be had at this office and from all newsdealers.

**EPPS'S COCOA**  
GRATEFUL—COMFORTING.



**FIRE-BRICK.—BY R. A. COOK, A.M.** An interesting description of the mining of fire clay and the manufacture of fire brick at Mt. Savage, Maryland where is located one of the largest establishments in the country devoted to this industry. Contained in SCIENTIFIC AMERICAN SUPPLEMENT, No. 538. Price 10 cents. To be had at this office and from all newsdealers.

**STANDARD ENAMEL WORKS, GROTON, N. Y.**  
Ornamental and Plain JAPANING on Metal, Wood, or Paper. PEARL INLAYING. Write for estimates.

**ALCOHOL, SWEET POTATO.—AN account of a new industry recently established at the Azores—that of the distillation of alcohol from raw sweet potatoes. Contained in SCIENTIFIC AMERICAN SUPPLEMENT, No. 572. Price 10 cents. To be had at this office and from all newsdealers.**

**PLAYS! PLAYS! PLAYS! PLAYS!**  
For Reading Clubs, for Amateur Theatricals, Temperance plays, Drawing-room Plays, Fairy Plays, Et cetera. Plan Plays, Guide Books, Speakers, Pantomimes, Tableau Lights, Magnesium Lights, Colored Fire, Burnt Cork, Theatrical Face Preparations, Jarley's Wax Works, Wigs, Beards, Moustaches, Costumes, Charades, and Paper Scenery. New Catalogues sent FREE! FREE! FREE! FREE!  
Containing many notices, full description and prices.  
**SAMUEL FRENCH & SON,**  
28 W. 23d St., New York.

**THE BARAGWANATH STEAM JACKET Feedwater Boiler and Purifier.**  
Boils the feedwater. Keeps the boiler clean. Saves boiler repairs. Saves from 15 to 40 per cent. of fuel. Large heating surface. No radiating surface. No back pressure. Thoroughly utilizes the exhaust. Strong and durable. Over 5,000 in use. Send for circular.  
**Wm. BARAGWANATH & SON,** 40 West Division Street, Chicago.  
**JAS. B. CROUTERS, M. E.,** General Eastern Manager, 112 Liberty Street, New York.

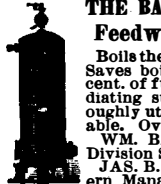

**EXCELLENT BLACK COPIES of anything written or drawn with any Pen (or Type Writer) by the Patent Autocopyist. Only equalled by Lithography. Specimens Free.**  
**AUTOCOPYIST Co.,** 166 William Street, New York.

**ELECTRIC CONVEYORS.—DESCRIPTION of two ingenious systems for the electric carriage of small packages. Illustrated with 13 engravings. Contained in SCIENTIFIC AMERICAN SUPPLEMENT, No. 464. Price 10 cents. To be had at this office and from all newsdealers.**

**2000 Fine Black copies of Writing, Drawing, Music. Works automatically with wonderful precision and rapidity.**  
**FAST AUTOMATIC COPIER**  
**FAST AUTOMATIC CO.,** 2 New Chambers St., N. Y.

**ELECTRICAL.** Edward P. Thompson, Solicitor Street, N. Y. Write for testimonials and instructions.

**NAVAL ARCHITECTURE.—AN interesting review, by Mr. R. Duncan, of the progress that has been made in this branch of science during the last fifty years. Contained in SCIENTIFIC AMERICAN SUPPLEMENT, No. 589. Price 10 cents. To be had at this office and from all newsdealers.**

**STEAM PUMPS for Hot or Cold, Fresh or Salt Water; for Oils, Naphtha, Tar; for Cane Juice, Liquors, Syrups, Scum; for Ammonia, Alkalies, Extracts, Acids; for Thick, Volatile, Viscous or Foul Liquids, etc. Vacuum Pumps of the highest efficiency. Filter Press Pumps. Air, Gas and Acid Blowers. Air Compressors, etc.**  
**BUILT BY GUILD & GARRISON, Brooklyn, N. Y.**

**SYSTEMS OF DISTRIBUTION OF Electricity.—A lecture by Elihu Thomson, delivered in the Sibley College course. The series, multiple arc, series multiple and multiple series, accumulator and induction systems described, and their advantages and disadvantages discussed. With 18 figures. Contained in SCIENTIFIC AMERICAN SUPPLEMENT, No. 603. Price 10 cents. To be had at this office, and from all newsdealers.**

**FREE.—We can in a day alleviate any case of if chronic. RHEUMATISM and quickly cure, even if chronic. Remedy purely vegetable; harmless. We send sample for one week's treatment, on receipt of 8 letter stamps for postage and packing. Write now. GALLENICAL MEDICINE CO., Box 1068 B, New Haven, Conn.**

**ICE & REFRIGERATING** Machines. York Patent. YORK MFG. CO., York, Pa.

**OTTO GAS ENGINES.**  
Over 25,000 sold.  
Horizontal..... Otto Gas Engines.  
Vertical..... Otto Gas Engines.  
Twin Cylinder..... Otto Gas Engines.  
Combined..... Otto Gas Engines and Pumps.  
Combined..... Otto Gas Engines and Dynamometers.  
**OTTO GAS ENGINE WORKS,**  
CHICAGO, PHILADELPHIA.  
New York Agency,  
18 Vesey Street.

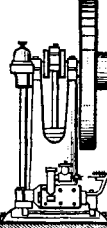

**ELECTRIC WELDING.—A PAPER BY Prof. Elihu Thomson,** giving an account of a new way of utilizing the heating effects of heavy electrical currents for causing union between pieces of metal, whether of the same or of different kinds. With 4 figures. Contained in SCIENTIFIC AMERICAN SUPPLEMENT, No. 592. Price 10 cents. To be had at this office and from all newsdealers.

**AMERICAN Leather Link Belt Co.**  
A new article in Belting which is made of small Leather Links joined together with steel bolts. They have been remarkably successful for hard working machinery and belts run half crossed.  
For prices and particulars write to  
**G. A. SCHIEBERN & CO.,**  
Ferry St., New York, 416 Arch St., Phila.; 86 Federal St., Boston.



**GLASS.—ABSTRACT OF AN INTERESTING lecture upon the subject, delivered by Sydney Lupton, M.A. before the Royal Society. Contained in SCIENTIFIC AMERICAN SUPPLEMENT, No. 592. Price 10 cents. To be had at this office and from all newsdealers.**

**BARREL, KEG, AND STAVE MACHINERY.**  
Over 20 varieties manufactured by  
**E. & B. HOLMES,**  
Buffalo, N. Y.  
Chamfering, Howeling, and Crosing.



**JAMES B. EADS.—AN ACCOUNT OF the life and labors of this eminent engineer. With a portrait. Contained in SCIENTIFIC AMERICAN SUPPLEMENT, No. 592. Price 10 cents. To be had at this office and from all newsdealers.**

**WELL TOOLS**  
Encyclopedia of 700 Engravings of Wells, Hydraulic Drills and Lightning Machines.  
Book free, 25c. for mailing it.  
**AMERICAN WELL WORKS,**  
Aurora, Ill.

**COCOINE.—DESCRIPTION OF DR. J. I. Corning's** system of administering this drug in painful nervous affections. With 8 figures. Contained in SCIENTIFIC AMERICAN SUPPLEMENT, No. 612. Price 10 cents. To be had at this office and from all newsdealers.

**MUSICAL, OPTICAL, ELECTRIC, MECHANICAL WONDERS.**  
**MAGIC LANTERNS & VIEWS**  
New and Improved.  
**HARBEACH'S PATENT**



**COMPRESSION OF AIR.—DESCRIPTION of Messrs. Dubois & Francois' improved air compressing machine, devised for the use of the larger industries and for mining purposes. With 8 figures, illustrating the apparatus in plan, elevation and detail. Contained in SCIENTIFIC AMERICAN SUPPLEMENT, No. 435. Price 10 cents. To be had at this office and from all newsdealers.**

**MODEL and EXPERIMENTAL WORK**  
Send for Circulars.  
**C. E. Jones & Bro.**  
CINCINNATI, O.  
(Mention this Paper.)

**ASPHALTUM AND THE PITCH LAKE of Trinidad.—By W. C. Crosby.** Origin of bitumens, Asphaltum, where found. The pitch lake of Trinidad. How the pitch is quarried. Origin of the lake. Contained in SCIENTIFIC AMERICAN SUPPLEMENT, No. 603. Price 10 cents. To be had at this office and from all newsdealers.

**VOLNEY W. MASON & CO.**  
FRICTION PULLEYS CLUTCHES and ELEVATORS  
PROVIDENCE, R. I.

**CASTING METALS UPON COMBUSTIBLE Materials.—A paper by A. E. Outerbridge Jr., describing a process of casting iron and other metals upon lace, embroideries, fern fronds, and other combustible materials. With 4 illustrations. Contained in SCIENTIFIC AMERICAN SUPPLEMENT, No. 601. Price 10 cents. To be had at this office and from all newsdealers.**

**WANTED.—Manufacturers' agency for staple line of goods for Ohio or Cincinnati and vicinity, or the exclusive agency for meritorious patented articles. Can furnish A1 reference as to business standing. Address A. W. K., P. O. Box 229, Cincinnati, O.**

**CAPILLARY TUBES, SPONTANEOUS Motion in.—A paper by C. Duchama upon the application of electricity to the study of the spontaneous oscillation of liquids in capillary tubes—the question being studied from a dynamic standpoint. With 10 engravings of apparatus and details. Contained in SCIENTIFIC AMERICAN SUPPLEMENT, No. 538. Price 10 cents. To be had at this office and from all newsdealers.**

**COLEMAN NAT'L BUSINESS COLLEGE.**  
National Patronage, Best Facilities, Best course of Business Training, Shortest Time, Lowest Rates, No Vacation.  
Address, H. COLEMAN, Pres.



**CURE FOR THE DEAF**  
PROF'S PATENT IMPROVED CURE—IONIZED EAR DRUMS Perfectly Restores the Hearing, whether deafness is caused by colds, fevers or injuries to the natural drums. Invariable, comfortable, always in position. Music, conversation, whispers heard distinctly. Write to F. H. SOOX, 845 Broadway, cor. 14th St., New York, for illustrated book of proofs FREE.



**Proposals for Machine Tools for the Ordnance Gun-Shops.—NAVY DEPARTMENT, WASHINGTON, D. C., November 2, 1887.—Sealed proposals will be received at this Department, until 12 o'clock noon, on Thursday, the 5th day of January, 1888, at which time and place they will be opened in the presence of bidders, for furnishing the necessary material and labor and constructing eleven (11) 6-inch gun lathes and one (1) slotter, and for the delivery and erection of the same in the Navy Yard, Washington, D. C. In accordance with plans and specifications copies of which, together with all other information essential to bidders, may be obtained at the Bureau of Ordnance, in this Department. Proposals must be made in duplicate, in accordance with forms which will be furnished on application to the Bureau of Ordnance, and enclosed in envelopes marked "Proposals for Machine Tools for Gun-Shops" and addressed to the Secretary of the Navy, Navy Department, Washington, D. C. The Secretary of the Navy reserves the right to reject any or all bids, as, in his judgment, the interests of the Government may require.  
D. B. HARMONY, Acting Secretary of the Navy.**

**Proposals for Machine Tools for the Ordnance Gun-Shops.—NAVY DEPARTMENT, WASHINGTON, D. C., November 2, 1887.—Sealed proposals will be received at this Department, until 12 o'clock noon, on Thursday, the 1st day of March, 1888, at which time and place they will be opened in the presence of bidders, for furnishing the necessary material and labor and constructing sixteen (16) 16-inch gun lathes, and for the delivery and erection of the same in the Navy Yard, Washington, D. C. In accordance with plans and specifications, copies of which, together with all other information essential to bidders, may be obtained at the Bureau of Ordnance in this Department. Proposals must be made in duplicate, in accordance with forms which will be furnished on application to the Bureau of Ordnance, and enclosed in envelopes marked "Proposals for 16-inch Gun Lathes," and addressed to the Secretary of the Navy, Navy Department, Washington, D. C. The Secretary of the Navy reserves the right to reject any or all bids, as, in his judgment, the interests of the Government may require.  
D. B. HARMONY, Acting Secretary of the Navy.**

**ASK YOUR STATIONER FOR THE JOHANN FABER LEAD PENCILS THE BEST NOW MADE**

**HYPNOTISM IN FRANCE.—AN interesting review of the present status of this subject, by Max Dessoir. Contained in SCIENTIFIC AMERICAN SUPPLEMENT, No. 613. Price 10 cents. To be had at this office and from all newsdealers.**

**Two-Horse Power Engine. \$75.**  
WITH STEEL BOILER, \$150.  
Cheap, Reliable, Safe.  
Automatic Boiler Feed. Automatic Pop Safety Valve, Steel Boiler. Cost of running guaranteed not to exceed three cents per hour. Nothing equal to it ever before offered for the price. Larger sizes equally low. Send for free descriptive circular.  
**CHAS. P. WILLARD & CO.,**  
236 Randolph Street, Chicago, Ill.



**WHAT AMERICAN ZOOLOGISTS HAVE Done for Evolution.—By Edward S. Morse.** Address of the retiring president of the American Association for the Advancement of Science, New York, Aug. 11, 1887. An interesting review of ten years' work performed by American Zoologists. Contained in SCIENTIFIC AMERICAN SUPPLEMENT, Nos. 607, 608 and 609. Price 10 cents each. To be had at this office and from all newsdealers.

**\$75 A MONTH** and expenses paid any active person to sell our goods. No capital required. Salary paid monthly. Expenses in advance. Full particulars free. We mean what we say.  
**Standard Silver Ware Co., Boston, Mass.**

**COSTS IN MANUFACTURES.—A LECTURE by H. Metcalfe, U. S. A., delivered in the Sibley College course.—An elaboration of a system for the management of factories and employes. A valuable paper. Contained in SCIENTIFIC AMERICAN SUPPLEMENT, No. 605. Price 10 cents. To be had at this office and from all newsdealers.**

**SUPERIOR Stationary Engines**  
with Plain and Automatic Cut-off, Vertical and Horizontal.  
**Penna. Diamond Drill Co.,**  
Birdsboro, Pa.



**HISTORY OF THE ELECTRICAL ART** in the U. S. Patent Office.—By C. J. Kintner. An interesting history of the growth of electrical science in this country, and notices of some of the more important models in possession of the Patent Office. Contained in SCIENTIFIC AMERICAN SUPPLEMENT, No. 544. Price 10 cents. To be had at this office and from all newsdealers.

**New Catalogue of Valuable Papers**  
contained in SCIENTIFIC AMERICAN SUPPLEMENT, sent free of charge to any address.  
**MUNN & CO.,** 361 Broadway, N. Y.

**HOW TO MAKE AN INCUBATOR.—Full directions, illustrated with 7 figures. Also directions for operating the apparatus. Contained in SCIENTIFIC AMERICAN SUPPLEMENT, No. 612. Price 10 cents. To be had at this office and from all newsdealers.**

**SAWS** How to Straighten and Gum all kinds. Address, A. E. WILBUR, Oneonta, N. Y.

**PROPULSION OF STREET CARS.—A paper by A. W. Wright, in which an endeavor is made to solve the problem as to the amount of power required to start a street car and keep it in motion under average conditions. Contained in SCIENTIFIC AMERICAN SUPPLEMENT, No. 533. Price 10 cents. To be had at this office and from all newsdealers.**

**\$10.00 to \$50.00** per night. A light and profitable business. Magic Lanterns and Views of popular subjects. Catalogues on application. Part 1 Optical, 2 Mathematical, 3 Meteorological, 4 Magic Lanterns, etc.  
**L. MANASSE, 88 Madison Street, Chicago, Ill.**

**19** Silk and Satin Neckties FREE. Agents' snap. Box and outfit, 12c. **NECKTIE CO.,** Augusta, Me.

**To Business Men.**  
The value of the SCIENTIFIC AMERICAN as an advertising medium cannot be overestimated. Its circulation is many times greater than that of any similar journal now published. It goes into all the States and Territories, and is read in all the principal libraries and reading rooms of the world. A business man wants something more than to see his advertisement in a printed newspaper. He wants circulation. This he has when he advertises in the SCIENTIFIC AMERICAN. And do not let the advertising agent influence you to substitute some other paper for the SCIENTIFIC AMERICAN, when selecting a list of publications in which you decide it is for your interest to advertise. This is frequently done, for the reason that the agent gets a larger commission from the papers having a small circulation than is allowed on the SCIENTIFIC AMERICAN.  
For rates set out of first column of this page, or address  
**MUNN & CO., Publishers,**  
361 Broadway, New York.

**CATARRH** positively cured by the great German Remedy. Sample pkge. and book for acts in stamps. **E. H. MEDICAL CO.,** East Hampton, Conn.

Advertisements.

Inside Page, each insertion - - - 75 cents a line. Back Page, each insertion - - - \$1.00 a line.

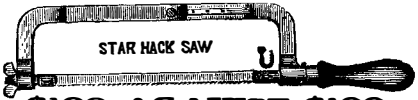

\$100 AGAINST \$100 That 10 Star Hack Saw Blades will cut as much Bar Steel as 50 of any other kind.



STAR HACK SAW GEO. W. MARBLE, Sole Manufacturer of THE ACME WRENCH.

BALANCE 1887 FREE To New Subscribers for 1888.

HAVING A Farm, A Garden, A Village Lot, A Home in the City, or Village, or Country,

or expecting to have one, IT WILL PAY YOU WELL,

to secure the Invaluable HELP, the BEST INFORMATION, the Thousands of Plain, Practical, Useful Hints and Suggestions, given in the American Agriculturist

all prepared by thoroughly experienced, intelligent Men, who KNOW well what they talk and write about.

Twelve Hundred Engravings in the Current Volume (1887) bring clearly to the understanding a great variety of Labor-Saving, Labor-Helping Plans and Contrivances, Illustrations of Animals, Plants, Buildings, Household Helps and Conveniences, Pleasing Pictures for Old and Young, etc., etc.

IT IS IMPOSSIBLE for Any One to consult these pages without gathering many Hints and Suggestions, EACH one of which is worth many times the small cost of this Publication for a whole year—only \$1.50, or four copies for \$5.—Single numbers 15 cents.

Try It for 1888; It will Surely Pay Well

FURTHERMORE.—Every subscriber who forwards the \$1.50 will immediately receive post-free, our splendid engraving, "Christ before Pilate."

Send six cents for mailing you the Premium number of the American Agriculturist, just out, containing four hundred Editorial, Contributed and Premium Descriptive Articles, written by 55 different contributors, representing 22 States and Territories, and the Provinces and Europe, and 240 illustrations by 20 different Artists, such as Forbes, Cary, Bennett, Mueller, Payne, Thompson, Faunce, Flohr, and Lyons, etc., whose work was done expressly for this number. Address

JUDD Co., David W. JUDD, Pres't, 751 BROADWAY, New York.

Publishers and Importers of all Works pertaining to Rural Life. Send Postal Card for our elegant Catalogue, describing Our 300 Books on Farm and Out-door Life Generally.



USEFUL BOOKS.

Manufacturers, Agriculturists, Chemists, Engineers, Mechanics, Builders, men of leisure, and professional men, of all classes, need good books in the line of their respective callings.

COMPLETE STEAM PUMP ONLY SEVEN DOLLARS DEMAND THIS PUMP OF YOUR DEALER OR WRITE TO US FOR PRICES.

COST OF PRODUCTION!

To new subscribers to THE OFFICE (a practical 32-page monthly, devoted to accounting, business management, and the art of advertising), we are sending, free, "Elements of Cost and Methods of Accounting in Steam Engine Works," by Fred. W. Child, Accountant for H. R. Worthington. Send \$1 to THE OFFICE COMPANY, Publishers, 37 College Place, New York.

LEPAGE'S LIQUID GLUE THE ONLY GENUINE

Used by thousands of first-class Manufacturers and Mechanics on their best work. Its success has brought a lot of imitators copying us in every way possible.

LIMITING NUMBERS OF TEETH IN Gear Wheels.—A valuable paper by George B. Grant treating of the different methods of determining the limiting numbers of teeth in gear wheels when small pinions must be used.

RUBBER BELTING, PACKING, HOSE.

Oldest and Largest Manufacturers in the United States. VULCANIZED RUBBER FABRICS For Mechanical Purposes. Air Brake Hose A Specialty. RUBBER MATS, RUBBER MATTING AND STAIR TREADS.

NEW YORK BELTING & PACKING CO., 15 PARK ROW, N. Y.

LEAD SMELTING.—A FULL DESCRIPTION of the Lewis Bartlett process, by William Ramsay; illustrated with 9 engravings. Contained in SCIENTIFIC AMERICAN SUPPLEMENT, No. 593. Price 10 cents. To be had at this office and from all newsdealers.

Steam! Steam!

We build Automatic Engines from 3 to 200 H. P., equal to anything in market. A Large Lot of 2, 3 and 4-H. Engines With or without boilers, low for cash. B. W. PAYNE & SONS, Elmira, N. Y.

PNEUMATIC DYNAMITE TORPEDO Gun.—An exhaustive account of this new weapon and of the experiments made with it; along with a description and illustration of a proposed dynamite cruiser, with 6 figures. Contained in SCIENTIFIC AMERICAN SUPPLEMENT, No. 593. Price 10 cents. To be had at this office and from all newsdealers.

MALLEABLE AND FINE GRAY IRON ALSO STEEL CASTINGS FROM SPECIAL PATTERNS THOMAS DEVLIN & CO. FINE FINISHING, PATTERNS, LEHIGH AVE. & AMERICAN ST. PHILA.

PATENTS.

MESSRS. MUNN & CO., in connection with the publication of the SCIENTIFIC AMERICAN, continue to examine improvements, and to act as Solicitors of Patents for Inventors.

In this line of business they have had forty-one years experience, and now have unequalled facilities for the preparation of Patent Drawings, Specifications, and the prosecution of Applications for Patents in the United States, Canada, and Foreign Countries.

A pamphlet sent free of charge, on application, containing full information about Patents and how to procure them; directions concerning Labels, Copyrights, Designs, Patents, Appeals, Reissues, Infringements, Assignments, Rejected Cases, Hints on the Sale of Patents, etc.

MUNN & CO., Solicitors of Patents, 361 Broadway, New York. BRANCH OFFICES.—No. 622 and 624 F Street, Par- office Building, near 7th Street, Washington, D. C.

The Original Unvulcanized Packing CALLED THE STANDARD—As it is the Packing by which all others are compared. Accept no packing as JENKINS PACKING unless stamped with our "Trade Mark."

THE COPYING PAD.—HOW TO MAKE and how to use; with an engraving. Practical directions how to prepare the gelatine pad, and also the antine ink by which the copies are made; how to apply the written letter to the pad; how to take off copies of the letter. Contained in SCIENTIFIC AMERICAN SUPPLEMENT, No. 438. Price 10 cents. For sale at this office and by all newsdealers in all parts of the country.

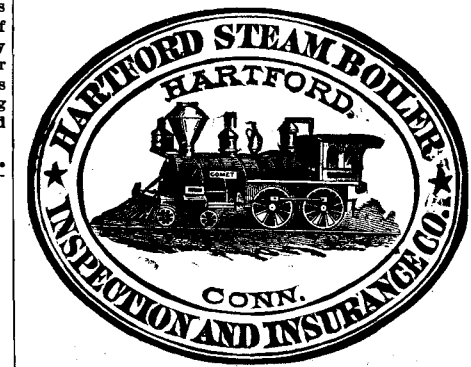

RAILS FOR STREET RAILROADS.—A paper by A. W. Wright, C.E., discussing the comparative value of iron and steel as materials for street railroad rails. Contained in SCIENTIFIC AMERICAN SUPPLEMENT, No. 499. Price 10 cents. To be had at this office and from all newsdealers.

Moss Engraving Co. 33 PEARL NEW YORK cor Elm St. OUR SPECIALTY: FINE ILLUSTRATED CATALOGUES BY OUR NEW PROCESS. Send Green Stamp for Monthly Specimens.

NOTES ON THE PANAMA CANAL.—A paper by R. N. Boyd, M. Inst. C.E., describing the present condition of the work on the Panama Canal, and discussing the question as to the time it will take to complete the work at the present rate of progress. Illustrated with a map. Contained in SCIENTIFIC AMERICAN SUPPLEMENT, No. 596. Price 10 cents. To be had at this office and from all newsdealers.

PATENT JACKET KETTLES, Plain or Porcelain Lined. Tested to 100 lb. pressure. Send for Lists. HAND, BURR & CO., 614 and 616 Market St., Philadelphia, Pa.

THE CHEAPEST AND BEST

PHOTO ENGRAVING CO. 67 PARK PLACE NEW YORK ENGRAVING FOR ALL ILLUSTRATIVE AND ADVERTISING PURPOSES

GOLD MINING MACHINERY.—DESCRIPTION of some new mining plants constructed in England for use in the Transvaal, Austria and Hungary. With 10 figures. Contained in SCIENTIFIC AMERICAN SUPPLEMENT, No. 593. Price 10 cents. To be had at this office and from all newsdealers.

PATENT RIGHTS FOR SALE. APPARATUS FOR BUILDING CONCRETE BUILDINGS AND WALLS. County Rights, \$50. State Rights, \$500. See descriptive notice in SCI. AMERICAN, May 22, 1886. Send for circulars. Ransome, 402 Montgomery St., S.F. Cal.

RESERVOIR DAMS.—A PAPER BY David Gravell, describing the prominent features of the typical masonry and earth work dams of the world. With 23 illustrations. Contained in SCIENTIFIC AMERICAN SUPPLEMENT, No. 595. Price 10 cents. To be had at this office and from all newsdealers.

GOLD MEDAL, PARIS, 1878. BAKER'S Breakfast Cocoa. Warranted absolutely pure Cocoa, from which the excess of Oil has been removed. It has three times the strength of Cocoa mixed with Starch, Arrowroot or Sugar, and is therefore far more economical, costing less than one cent a cup. It is delicious, nourishing, strengthening, easily digested, and admirably adapted for invalids as well as for persons in health. Sold by Grocers everywhere.

W. BAKER & CO., Dorchester, Mass.



THE AMERICAN BELL TELEPHONE CO. 95 MILK ST. BOSTON, MASS.

This Company owns the Letters Patent granted to Alexander Graham Bell, March 7th, 1876, No. 174,465, and January 30th, 1877, No. 186,787.

The transmission of Speech by all known forms of Electric Speaking Telephones infringes the right secured to this Company by the above patents, and renders each individual user of telephones not furnished by it or its licensees responsible for such unlawful use, and all the consequences thereof, and liable to suit therefor.

H. W. JOHNS' ASBESTOS COVERINGS.

For Furnaces, Hot-Air Pipes, etc. FIRE-PROOF. NON-CONDUCTING. 33% of Fuel Saved. Has no Odor. All of the heat is carried to points desired and not wasted in cellars and flues.

H. W. JOHNS M'FG CO., 87 MAIDEN LANE, NEW YORK.



PROSPECTUS OF THE Scientific American

FOR 1887. The Most Popular Scientific Paper in the World. Only \$3.00 a Year, including Postage. Weekly. 52 Numbers a Year.

This widely circulated and splendidly illustrated paper is published weekly. Every number contains sixteen pages of useful information and a large number of original engravings of new inventions and discoveries, representing Engineering Works, Steam Machinery, New Inventions, Novelties in Mechanics, Manufactures, Chemistry, Electricity, Telegraphy, Photography, Architecture, Agriculture, Horticulture, Natural History, etc.

Terms of Subscription.—One copy of the SCIENTIFIC AMERICAN will be sent for one year—52 numbers—postage prepaid, to any subscriber in the United States or Canada, on receipt of three dollars by the publishers; six months, \$1.50; three months, \$1.00.

Clubs.—One extra copy of the SCIENTIFIC AMERICAN will be supplied gratis for every club of five subscribers at \$3.00 each; additional copies at same proportionate rate.

The safest way to remit is by Postal Order, Draft, or Express Money Order. Money carefully placed inside of envelopes, securely sealed, and correctly addressed, seldom goes astray, but is at the sender's risk. Address all letters and make all orders, drafts, etc., payable to

MUNN & CO., 361 Broadway, New York.

THE Scientific American Supplement.

This is a separate and distinct publication from THE SCIENTIFIC AMERICAN, but is uniform therewith in size, every number containing sixteen large pages. THE SCIENTIFIC AMERICAN SUPPLEMENT is published weekly, and includes a very wide range of contents. It presents the most recent papers by eminent writers in all the principal departments of Science and the Useful Arts, embracing Biology, Geology, Mineralogy, Natural History, Geography, Archeology, Astronomy, Chemistry, Electricity, Light, Heat, Mechanical Engineering, Steam and Railway Engineering, Mining, Ship Building, Marine Engineering, Photography, Technology, Manufacturing Industries, Sanitary Engineering, Agriculture, Horticulture, Domestic Economy, Biography, Medicine, etc. A vast amount of fresh and valuable information pertaining to these and allied subjects is given, the whole profusely illustrated with engravings.

The most important Engineering Works, Mechanisms, and Manufactures at home and abroad are represented and described in the SUPPLEMENT.

Price for the SUPPLEMENT for the United States and Canada, \$5.00 a year, or one copy of the SCIENTIFIC AMERICAN and one copy of the SUPPLEMENT, both mailed for one year for \$7.00. Address and remit by postal order, express money order, or check.

MUNN & Co., 361 Broadway, N. Y., Publishers SCIENTIFIC AMERICAN.

To Foreign Subscribers.—Under the facilities of the Postal Union, the SCIENTIFIC AMERICAN is now sent by post direct from New York, with regularity, to subscribers in Great Britain, India, Australia, and all other British colonies; to France, Austria, Belgium, Germany, Russia, and all other European States; Japan, Brazil, and all States of Central and South America. Terms, when sent to foreign countries, Canada and Mexico, excepted, \$4. gold, for SCIENTIFIC AMERICAN, one year; \$9, gold for both SCIENTIFIC AMERICAN and SUPPLEMENT for one year. This includes postage, which we pay. Remit by postal or express money order, or draft to order of MUNN & CO., 361 Broadway, New York.

PRINTING INKS.

THE "Scientific American" is printed with CHAS T. ENET JOHNSON & CO.'S INK. Tenth and Lombard Sts., Phila., and 47 Rose St., opp. Duane St., N. Y.

Shafting and Gearing, Textile Machinery, ELEVATORS, ETC. THOS. WOOD & CO., 224 and Wood Sts., Philadelphia, Pa.