

Scientific American

A JOURNAL OF PRACTICAL INFORMATION IN ART, SCIENCE, MECHANICS, AGRICULTURE, CHEMISTRY, AND MANUFACTURES.

VOL. 1.—No. 12.

NEW YORK, SEPTEMBER 17, 1859.

NEW SERIES

PARCE'S HOISTING CRANE.

The accompanying engraving represents an improved hoisting crane. The device for bracing the arm against the twist, or torsion strain, will attract the attention of such of our readers as take an interest in mechanical contrivances. To the post, A, which turns on pivots, the main arm, E, is firmly fastened. By means of a hinged joint, the outer arm, F, is connected with the main arm, E; the pin of this hinge is oval in form, and is firmly fastened into the main arm, E, so that it cannot turn, with its largest axis perpendicular to the line of the arm. The jointed arm, F, turns about this pin; the holes in F, through which the pin passes, being round, and fitting the pin loosely. The object of this arrangement is to hold the end of the arm, F, up horizontally when it is turned at right angles to the main arm, E. The rope, G, passes between friction rollers, m, the axes of which are vertical.

The description of the bracing device we copy from the specification: "The main arm, E, is strengthened by means of double diagonal braces, I, which are united by a stay, r, which passes freely through an aperture, S, in the arm, E, without touching any part of the same, and the several arms, t and t', are attached to the arm by means of bolts or rivets, u u' u'' and u''', as clearly represented in Fig. 1; and all the arms, t t', are secured in the center to the stay, r, by means of nuts, v, as represented in Fig. 2."

* * * "If the weight be brought into a position, as represented in dotted lines in Fig. 2, the strain exerted by the same on the main arm, E, has a tendency to twist the outer end of the same, so as to turn the bolt, u', out (Fig. 1), and the bolt, u, in; but any strain which has a tendency to twist the outer end of the main arm, E, in this direction is brought to bear on the bolts u'' and u''', by means of the arms, t and t', of the brace, I; and, as the stay, r, passes freely through the aperture, S, in the main arm, E, any little motion in the braces, t and t', has no effect on the central part of the arm."

The object of this bracing is to allow the arm to be swung with less power than would be required if it was allowed to twist; and "that the strain exerted by the weight on the arm may be brought to bear on that part of the same where it joins the post." If the bent arm twists with a heavy weight at the end, in swinging the arm out straight, we are obliged to raise the weight, with a useless expenditure of power.

The proprietors of this patent are Messrs. Deland & Parce, Fairport, N. Y., and they will be happy to answer any inquiries in regard to it. The patent on this crane was granted July 26, 1859, to J. Y. Parce.

WHAT IS THE CAUSE OF HONEY-DEW?

A correspondent presents for our consideration the above inquiry, concerning which little is generally known; in fact it is one of the most curious and interesting subjects which have ever attracted the attention of observers. Honey-dew is a liquid sugar, the excrement of plant lice, called by entomologists, *Aphides*. They cling to the under side of leaves, and drop the excrement down upon the leaf below. The *Aphides*, from a most extraordinary peculiarity of their propagation, have been the object of long, patient, and very close observation on the part of three or four different naturalists, and strange as it may seem, it is fully settled that the young of a brood are all females, and these carefully excluded from the instant of birth in tight vessels, also have young without ever seeing the male. This continues for ten generations. But the tenth generation, wonderful to relate, is composed of both males and females. The un-

for depriving water of this fault have fulfilled the expectations as regards lime, but act very little on the magnesia. The new method of Buff & Versmann allows any water to be freed from lime as well as magnesia. The substances used are of the very cheapest description. Water of any degree of hardness can readily be softened by adding the substances in due proportion, and the salts used are perfectly innocuous in washing the goods as well the persons employed." The substance employed is a mixture of silicate and carbonate of soda, or in place of the latter some compound able to precipitate the lime. The proportion required is found by determining the degree of hardness of the water by Clark's method, taking for each hectoliter three grammes of anhydrous carbonate of soda (or sal soda in proportion) for every degree of hardness indicated, and as much silicate of soda as contains three grammes (46 grains), of silicic acid for each gramme of magnesia contained in the water. After stirring in these compounds the whole is allowed to rest for a day or more, and the clear purified water drawn off.—*Dingler's Polytechnic Journal*.

THE CROW.—"Down east" the crow is regarded as a great pest; so great that the genius of invention is taxed to produce all kinds of scare-crows, and yet the *Atlantic Monthly* dares to defend him in the following terms:—"He consumes in the course of the year vast quantities of grubs, worms and noxious vermin; he is a valuable scavenger, and clears the land of offensive masses of decaying animal substances; he hunts the grass fields, and pulls out and devours the underground caterpillars, wherever he perceives the sign of their operations, as evinced by the wilted stalks; he destroys mice, young rats, lizards and serpents; lastly, he is a volunteer sentinel about the farm, and drives the hawk from its enclosures, thus preventing greater mischief than that of which he is himself guilty. It is chiefly during seed time and harvest, that

the depredations of the crow are committed; during the remainder of the year we witness only his services, and so highly are those services appreciated by those who have written of birds, that we cannot name an ornithologist who does not plead in his behalf."

OUR PINE FORESTS.—The *Baltimore Exchange* says: "Those persons who have been accustomed to regard the pine forests of the South as of little commercial importance, will be surprised to learn that the annual value of the hewn timbers, the sawed plank, boards, scantling, rosin, pitch, and turpentine, is estimated to be not less in the aggregate, than from twelve to fifteen millions of dollars.

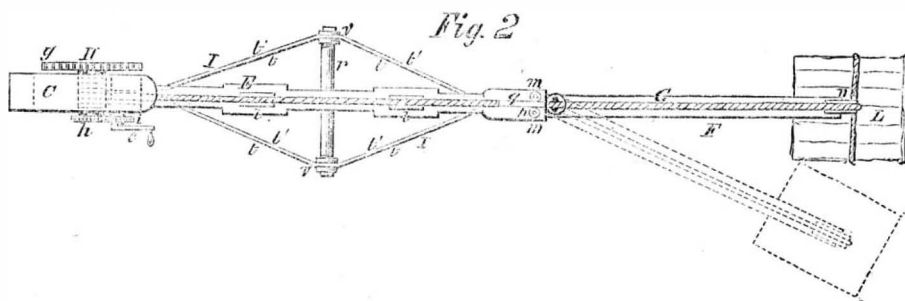
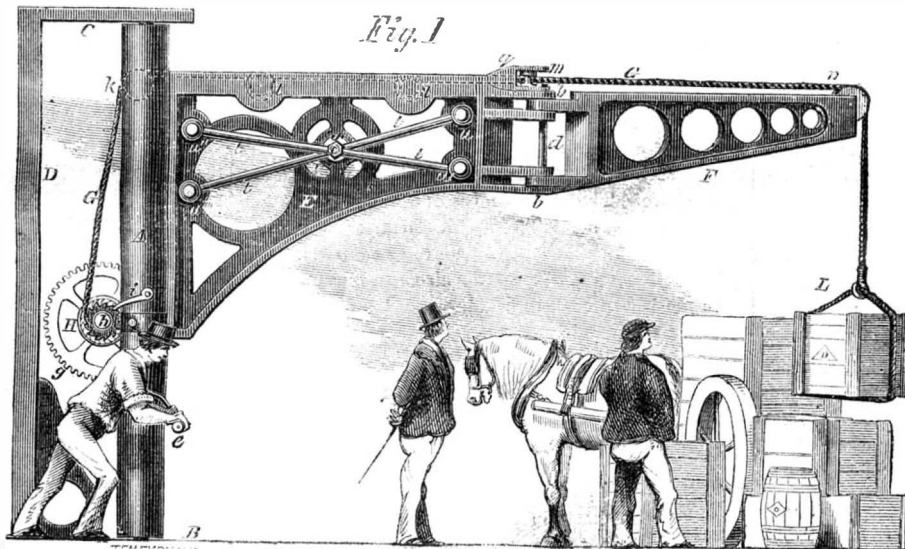

PARCE'S HOISTING CRANE.

equivocal amours of these have been watched with the most intense interest by M. Bonnet and others, and there seems to be no doubt that the males of one generation render the females fruitful for the next ten generations.

There is another entirely different substance sometimes called honey-dew, which is secreted from the plants on which it is found.

METHOD FOR PURIFYING HARD WATER.

Buff & Versmann, of England have introduced a substance under the name of "Holland Compound" for the purpose of rendering soft and purifying water. Prof. A. W. Hofman, of London, says of it: "The hardness of water is caused by the lime and magnesia salts contained in it. The various remedies heretofore proposed

A FLYING TRIP TO THE WEST.

[Special Correspondence of the Scientific American.]

MESSRS. EDITORS:—The great Pennsylvania Railroad, along which I have come, is one of the few in the country in which speed is obtained with safety and comfort to the passengers. It is so illustrious an exception to the common rule as to deserve notice, and as I am deputed by you especially to describe the important inventions with which I may meet, and as a most important one is in practical operation on this road, I have stopped over at Altoona to examine it carefully and look through the well-appointed shops of the company. You, who have traveled everywhere and know everything of importance, are aware that the whole track from Philadelphia to the "Smoky City" is bedded with stones, and that one is not suffocated with dust, as on some other of our great routes; and when I tell you that the wooden bridges are being replaced by iron ones, that new and powerful engines are being continually brought into use, that watchmen pass continually along the line to notice derangements or defects in the track, and that the vigilant eye of Mr. Superintendent Scott is upon every department of the service, our readers will see that a trip over the Pennsylvania Railroad is not only pleasant from the nature of the country and instructive from the unexampled specimens of engineering which are to be seen, but can be made with an almost positive assurance of personal safety.

I met the superintendent upon the train, and as I expressed surprise at the manner in which the train was controlled, he was good enough to let me ride upon the engine to see the practical working of the Loughridge patent brake. This most excellent invention has been in operation upon this road for four or five months, and after being subjected to every variety of test, has proved its efficiency and utility to such a degree that the company have adopted it and are making arrangements to apply it to every train on the road. I was assured that a train moving at the rate of 30 miles per hour can be stopped in 600 feet after the brakes are applied, and without damage to the engine or cars. The engineer told me he was satisfied he could bring his train to a stop in the time that would be required under the old system to whistle "on brakes," and that he felt that one-half the risk of his occupation was removed.

This was my first ride upon an engine. The night was very dark, even the stars being obscured by clouds. We were a little behind time, and the speed of the train was rapidly increased to 45 miles per hour. What were my sensations you may perhaps imagine. The black darkness around us; the mass of the engine, made blacker and more cumbrous by the glare from the head-lantern, and swaying unsteadily from side to side; the infernal scream of the whistle as we neared crossings, the flitting-by of mile-posts, telegraph-poles, piles of wood, cabins, and other objects that for one instant were lit up by the streaming rays of the lantern, and then leaped madly into the gulf of darkness beside us; miles upon miles of fence that melted from our sight like thread passing through flame; the grimy features of the fireman frequently illumined as the door of the fire-box was opened; all this, with the passage over steep embankments of unknown height, and of bridges that seemed supported in mid-air, kept my senses in a keenly active state. Although I had come to examine the patent brake, I could not look at it until I had become somewhat familiar with the novel situation, and when I did turn to look at it, it was with difficulty that my stunned organs of hearing could distinguish the words that Mr. Scott vociferously shouted to me as we flew along "at headlong speed."

Its construction is as follows: Alongside the throttle lever there is another lever which communicates with a 10-inch friction-wheel, and presses it against the flange of the rear driver, at will. This causes it (the friction wheel) and its shaft to revolve, and a chain attached to the brakes throughout the train is wound on the shaft. On the shaft is a ratchet wheel with a pawl, so that as the chain is wound to any given strain it is kept in place. In connection with it is a weighing-beam by means of which the power may be graduated on the brakes to suit the condition of the rails. A weight sliding on the notched weighing-beam gives more or less power as it is slipped from or to the fulcrum, and, once gaged, the engineer cannot put more power on the brakes if he wished, or should not wish, to; but he can apply any degree less than the fixed maximum down to zero. The beam is

fixed so that the engineer cannot slip the wheels, nor break the chain, but can get what power he wishes up to the slipping point. And this is all that is requisite, for if the wheels are slipped, the retarding power is lessened rather than increased. To loose brakes, a small lever is pulled, and the pawl being thrown out of the ratchet, the chain is suffered to unwind. The great beauty of the contrivance is the weighing-beam, for if the power were not gaged, the engineer by braking up too suddenly, would snap any chain that might be used. To relieve the enormous shock which comes upon the pawl as it is thrown into the ratchet, the inventor has attached to its end a long gum spring, which effectually absorbs the sudden strain. The lever once thrown back, the ratchet and pawl below hold the brakes in place, so that the engineer need only put on the required power, and may then give his attention to the working of his engine. Coming to a station the speed of the train may be so controlled that the reverse gear need never be used. The cost of applying the brake to an engine is \$75: to an ordinary car but \$30. Until I took my first engine-ride I could not have realized the value of this invention. It needs to see with what marvelous ease the train may be controlled; how, when going at express speed, it can be arrested at once and without injury, and how, when approaching a station, the motion may be made to diminish by regular degrees until just at the right time the engine stops at the wood-shed or water-tank. When we reflect that frequently thousands of dollars and many valuable lives might be saved if a train could be stopped 500 feet sooner than is now possible, we see the value of this patent brake, and if other roads do not imitate the action of the Pennsylvania Central, it certainly will not be because Mr. Loughridge has not done his part.

In looking through the company's shops I noticed a new smoke-consuming fire-box, the patent for which was taken in our office. It is the invention of Gill and Grier, and has just passed successfully through a long comparative test with several other engines. It has been used on one engine for four or five months, and is said to work well. In the fire-box is a deflector of copper and iron, with a water space inside it, through which pass 900 $\frac{1}{4}$ -inch air tubes which communicate with an air-space above. The air space passes down to the bottom of the fire-box, and is fitted with a damper which enables a larger or less quantity of air to be admitted, as required. The air passes up the air-chamber and down upon the bed of coal, in jets through the $\frac{1}{4}$ -inch tubes. This gives oxygen in proper quantity to every part of the flame, materially aiding the combustion of the smoke and gas. The patentees claim the introduction of air over and down upon the fire. With this apparatus an engine works free of smoke with an open stack, and the saving of fuel is claimed to be equal to the old waste of smoke, gas and sparks, equal to about 30 per cent. By using an open stack, of course, a longer exhaust can be used, and it is not necessary to cramp the engine to such a degree.

Of the grades over mountains, and the seeming impossibilities which by American genius have been overcome, I need not speak, for they are known to every one; but of the company's shops I will say a word. They are all built of brick in the most substantial manner, have slate roofs, and cost at least \$500,000. In the machine-shop is as pretty a line of shafting, 400 feet long, as I ever saw. It, and most of the finest tools were made by Sellers, of Philadelphia. The shafting has been run for seven years, and has never needed lining up, nor repairs. The pattern-loft contains the patterns for the whole road. Each piece is stamped with a number and a register is kept, duplicates of which are furnished to the other shops. By this plan articles can be ordered by their appropriate numbers, and they are cast in the Altoona foundry as wanted.

I shall go hence, according to my instructions, to the great West, and hope to get near enough to Freeport, Illinois, to see the trial of steam plows, but shall certainly see the fairs to attend which I have been sent.

Altoona, Pa., Sept. 10, 1859.

HELIX.

CANNEL COAL AND ITS OILS.

MESSRS. EDITORS:—An article with the above title, which appeared on page 151 of the present volume of the SCIENTIFIC AMERICAN, is calculated to convey a wrong impression with regard to a branch of manufacture rapidly increasing in importance. I allude to that portion

of it in which the writer says that "two mines of cannel coal are at present known on this continent," of course conveying the impression that these are the only sources of supply, which, he further states, are mainly consumed at two places mentioned by him. His premises being correct, it would follow that these parties are the only ones who can furnish the true coal-oil. On the contrary, it is well known that the southern and south-eastern borders of the great Illinois coal-field, lying in north-western Virginia, northern Kentucky and the southern part of Ohio, contains vast beds of cannel coal. What is known as the "Root Vein," for instance, has been traced for many miles along the Kanawha, and its tributaries, and extends to a great distance on either side of that stream; while many other deposits, varying from eight feet to a few inches in thickness, has been discovered. There is, therefore, no scarcity of cannel coal, and the advantages indirectly claimed by your correspondent for the two companies mentioned, are far from being the fact.

But I will go further, and say that neither of the coals mentioned is truly cannel coal. The mineral known in commerce by this designation is characterized, chemically, by a larger proportion of hydrogen than other coals; it is generally of a brownish color, of a low specific gravity, exceedingly tough, breaks with a conchoidal fracture, and burns freely with a smoky flame. In some specimens it borders closely on lignite. Under no circumstances, however, will it become soft and "elastic as india-rubber," which fact at once characterizes the Forest Hill coal as certainly not cannel, whatever it may be. It approaches much nearer to bitumen in character, I should think, though I have never seen it. The Albert coal appears to be an article *sui generis*, but is certainly nearer allied to bituminous coal or bitumen than to cannel coal.

The statement of your correspondent with regard to bituminous coal is correct in the main. Burning oil can be made from bituminous coal; but it can never be a profitable operation, as the quantity is too small and the difficulty of purifying it very great. A very important distinction, and one which characterizes both oils, is, that while the solid ingredient of cannel oil is mainly paraffine (C₂₀ H₂₀), bituminous oil, as well as that from the Albert coal, contains naphthaline as the solid ingredient, with a very small per centage of paraffine. The latter substance is the best solid illuminating ingredient yet discovered. Agreeing in composition with oiliant gas (the illuminating portion of coal gas), it burns without smoke and gives a pure light of great intensity. Naphthaline, on the contrary, from its large per centage of carbon, is totally useless as a burning material, and has not, as yet, been found of practical value in the arts. I say not as yet, for I believe it will yet be found exceedingly valuable, yielding, by its decomposition or combination, substances of great economic value. Alizarin, for instance, the drying principle of madder, is identical in composition with one of the derivatives of naphthaline, and not unlikely will yet be obtained from it; and other instances of a similar coincidence might be mentioned. There is here a most promising field of discovery.

The different composition of paraffine and naphthaline gives a key to the different characters of crude coal oils; but as this letter has already reached too great a length, I will reserve till another opportunity the consideration of their character and composition.

H. S.

Stamford, Conn., Sept. 3, 1859.

CORNS AND CHILBLAINS.

MESSRS. EDITORS:—The following effectual methods of treating corns and chilblains may be of use to many of the readers of the SCIENTIFIC AMERICAN:—

A corn, when closely pared, resembles an onion in its layer. The way to treat it is to use a sharp pointed knife and commence paring at the center, taking care to remove layer after. This may be done without causing pain or drawing blood. When the whole corn is removed a cavity is formed in its place, protected by the natural flesh and skin. This is now to be covered with a piece of common sticking plaster, which should be kept on for one or two weeks. For chilblains, I have found that warm linseed oil rubbed on them is a very good remedy, and to this I sometimes add a little spirits of turpentine.

E. S.

New York, Sept. 12, 1859.

ABSTRACT SCIENCE AND PHILOSOPHY.

MESSRS. EDITORS:—I perceive that the press speaks slightly of the proceedings of the American Scientific Association, in relation to abstract philosophy, which induces me to offer the following suggestions:—

1. Must not philosophy in the abstract precede that of the practical?

2. Must not a principle in philosophy and mechanics be first known to exist before it can be understood, and be understood before it can be reduced to practice? If so, the abstract knowledge of its existence precedes its practicability and usefulness.

3. Do not all natural compounds contain water? If so, then, did not the creation of water precede the formation of natural compounds?

4. Was not electricity once considered as an abstract principle of nature? What followed? Its utility, &c.?

5. Can vegetable and animal life exist upon air alone? No. Neither can such exist without it. Therefore, was it not necessary that the creation of the air should have been prior to that of vegetable and animal life?

6. Was not the expansion of fluids by heat once known as an abstract principle of nature? And from whence came the steam-engine? From chance? No. From an abstract knowledge of the principles of expansion, &c.

7. Does not abstract philosophy bear the same relation to practical science as the discovery of a new continent does to its colonization, and that of clearing the land previously to its agriculture?

8. Does not abstract philosophy constitute a basis upon which the practical man raises his structure of usefulness?

9. If abstract philosophy, when investigated, produces such good results for man (the American Scientific Association investigates abstract philosophy), is not man benefited thereby?

J. Q.

New York, Sept. 7, 1859.

[1. If our correspondent means by "philosophy in the abstract" a knowledge of causation, we return a negative answer to his interrogation. There are many artists, physicians and others who practice certain rules with great success, and yet cannot explain the why and wherefore of the results produced.

2. We answer "no" to this question. The principle of gravitation was applied to turn water-wheels and operate machinery, ages before the law of gravitation was discovered. An abstract knowledge of its existence did not precede its practicability, but a knowledge of this law is useful and indeed necessary to every mechanic. With such knowledge, we can tell the power of any waterfall by measuring its height; without a knowledge of it, we could not construct such a motor except by "guess work." As the source of a river is reached by navigating from the outlet up to the fountain-head, so in the practical arts, principles are generally discovered through practice. Archimedes and others constructed great machines without a knowledge of the law of *inertia*, which lies at the very foundation of the science of mechanics.

3. We return a negative to this question, and must say it is not a proper one. Water itself is a natural compound, being composed of oxygen and hydrogen. Its creation, therefore, could not have preceded that of natural compounds. Even if it were a simple body, we could not draw the inference of its precedence in the work of creation by any of its combinations with other bodies.

4. Electricity was never considered an abstract principle of nature, but a mysterious agent—a power, and and it is just as mysterious as ever. Many useful applications of electricity to the arts have been made by persons unacquainted with what some call "its principles."

5. We believe that the atmosphere was created before the organic creation, but they might have been created at the same time.

6. Of course the steam-engine was not a work of chance, but it was invented before the law of the expansion of fluids was discovered; it was the product of experiment. "An abstract principle of nature" is something rather indefinite. If a certain mode of operation is meant, then it is a law of nature, such as gravity and inertia.

7. The comparison of our correspondent in this interrogation is very beautiful; but as the discovery of a continent depends upon a practical act, like that of Colum-

bus navigating his frail bark to "the western land," it is very different in its nature from abstract principles.

8. Abstract philosophy is not the basis upon which the practical man raises his useful structure. Our whole progress in modern science and art is due to experiment and observation, commenced first by Galileo in the 16th century.

9. To this question we will present some general information on the whole subject of science. In regard to abstract philosophy, we are still in doubt whether electricity, light and heat are qualities or substances. Yet many important properties or laws have been discovered, by means of which heat, light and electricity (whether they are properties or substances) have been regulated and employed, and from this we probably derive as much advantage as could be obtained from a complete knowledge of their essence. If by "abstract principles in nature"—as some understand the term—the essence of qualities and powers, such as gravity *per se* is meant, no one essence has yet been discovered, with all the advances which have been made in science. In short, our whole scientific knowledge is practical, as founded upon the philosophy of Bacon. We may have mistaken some of the views of our correspondent; probably our opinions are more in concord than they appear to be from the language we have both used.—EDS.

EAGLES—ORNITHOLOGY.

MESSRS. EDITORS:—I claim to have made a discovery in natural history, not laid down in any books which I have seen. In the winter of 1853 my son shot a large grey eagle, which measured nearly eight feet from tip to tip of the wings. One of the wings only was broken, so he was captured alive. He seemed to be an old eagle, was quite fierce, and so we kept him loose in our backyard and fed him for three years. After this he was given to Walter Hulet, of Niagara Falls, and within 18 months afterwards he changed his coat and became a bald eagle. His body is now nearly black, and his head and tail white as snow. This has confirmed my previous opinions that bald eagles are old grey eagles. I was led to this conclusion about 10 years ago by knowing the resting-place of these eagles on the west bank of Cayuga Lake, and where I saw the grey and the bald eagle living apparently in the same family. If I remember aright, Audubon has classed the grey, black, bald and golden eagles separately; but from the eagle now at Park Place, Niagara Falls, it is proved that the grey and bald, at least, are the same species. The only thing now to be ascertained is the period when the grey eagles change their coats. This one must have been old when he was shot, because if he had been young he might have become somewhat tame in six years; but he is still vicious as a hyena, and in captivity has never learned to forage much for his own food.

J. P. C.

Seneca Falls, N. Y., Sept. 6, 1859.

THE SCIENTIFIC ASSOCIATION.

MESSRS. EDITORS:—I am sorry to see you, in your later numbers, ridiculing and carping at the members of the "Scientific Association," because you do not see that their studies and discussions are immediately useful. I cannot help thinking that the same spirit (if you had lived in those days) would have led you to hoot at Franklin for flying his kite at a thunder-cloud, or to have rebuked Galvani for spending his time in watching the twitchings of the hind legs of a dead frog; for you might not have foreseen the useful inventions that have resulted from their studies, any more than you can now foresee what valuable knowledge may be added to the general stock by diligent and careful observations of comet's tails and the Old Red Sandstone rocks. Which of the Great Creator's works is it beneath man's dignity to study?

WM. D. ARNOLD.

Beloit, Wis., Sept. 3, 1859.

[In answer to the concluding sentence of our correspondent, we say it is an honor for man to be permitted to study any of the works of the Divine Creator. We are of opinion, however, that his views and ours are not exactly reconcilable in regard to the transactions (not the members) of "The Association for the Advancement of Science." We would remind him that it is just such experiments as those of Franklin and Galvani which we have always advocated as the positive means of producing positive results. It was no less a body of *savans*

than the members of the Royal Society of England—those who considered themselves the embodiments of science—that coughed in derision at the recital of Franklin's experiments; and we therefore think he has altogether misapplied the transaction to us. We reiterate our views expressed on page 139, relating to the undue prominence that was given to papers upon merely speculative subjects.—EDS.

CANADIAN LAKE AND OCEAN NAVIGATION.

In the SCIENTIFIC AMERICAN of the 13th ult., a short paragraph appeared in which it was stated that the western Canadians had at length imitated the Americans in sending one of their vessels from a lake port to Europe direct. We have received two communications from Canadian correspondents, in which they assert that Canadians sent the first vessel to Europe direct, and we submit their proofs of this statement. The following is the interesting letter of our Kingston correspondent:—

MESSRS. EDITORS:—The first vessel that ever left the upper lakes for Europe was the bark *Lillie*, built near Kingston, C. W., for Capt. Hunter (now of Quebec), and sent from here, in the spring of 1848, for Liverpool, where she was sold and sent to the coast of Africa to traffic with the natives; but was lost on the coast of Ireland, where some wreckers, not knowing there was gunpowder on board, blew themselves and the vessel to pieces. The next vessels were the bark *Cherokee*, 400 tons, built by I. Counter, for Capt. Gaskin, and the bark *Arabia*, 450 tons, for J. Boyd & Co., in the winter of 1852-3. The first was sent in 1853 with a cargo of flour from Toronto to Liverpool, where she was sold, but the *Arabia* did not sail till 1854 for Liverpool, and after an unprosperous voyage returned in 1855, and has been on the lakes ever since. She is at present loading in Chicago. In the winter of 1852-4 a second vessel was built for the same parties as the *Cherokee*; namely, the bark *Cataragus*, 650 tons. She left Kingston in 1854 with staves, arrived at London, where Capt. Gaskin sold her, and in the winter of 1854-5, built the ship *Eliza Mary*, 850 tons, which left Kingston with staves for Liverpool in 1855. A description of Capt. Gaskin's three vessels, also a view of the *Cataragus* descending the Galop Rapids, will be found in the *Illustrated London News* of August the 12th, 1854.

The schooner *Dean Richmond*, which was the first American vessel that went to Europe direct, did not go till 1856.

The dates, cargoes, destinations, and list of American vessels which have sailed, will be found in the *Detroit Advertiser*, about the middle of May, 1859.

J. P. D.

Kingston, C. W., Sept. 1, 1859.

The following is also an interesting letter from our Toronto correspondent:—

MESSRS. EDITORS:—During the season of 1857 two Canadian-built vessels left the port of Toronto for Liverpool, namely, the bark *Reindeer*, 800 tons, loaded with staves and lumber, and the full-rigged ship *City of Toronto*, 600 tons, built at Toronto and loaded partly here and partly at Quebec. Also, in May 1858, the three-masted schooner, *Indian Queen*, 400 tons, (built at Coldwater on Lake Huron, and known in the Collingwood and Chicago trade) sailed from this port loaded, and made the passage from Quebec to Liverpool in the short space of 25 days.

It is hardly necessary for me to say these vessels all arrived safely at their destination.

J. C. S.

Toronto, C. W., Sept. 1, 1859.

EARLY LOCOMOTIVES.—According to the *American Railroad Guide*, the first locomotives in the United States were imported from England, in the Fall of 1829 or Spring of 1830. The first Stephenson locomotive ever imported was the "Robert Fulton" in 1831, for the Mohawk and Hudson Railroad. The first locomotive built in this country was constructed at the West Point Foundry in 1830, for the South Carolina Railroad. The second was built for the same road at the same place. The third was built by the same establishment in the spring of 1831, and was the first locomotive ever run in the State of New York. David Matthew, who first run this engine, is still living in Philadelphia, and is one of our oldest inventors and locomotive engineers.

HOT-AIR OVENS FOR IRON FURNACES.

[Continued from page 164.]

It was seen that the defects of the plan Fig. 3 consisted, principally:—First, in exposing so great a continuous length of pipe to the action of the heat, thus augmenting the actual amount of expansion in each straight length of pipe, the effect of which would be concentrated upon the weakest point in that length, and, at the same time, subjecting the whole apparatus to all the ill effects of any irregular expansion or contraction of the heating main at any one point; second, in such an arrangement of the grates as was necessarily accompanied with an irregular action of the heating main at each time of successive firing and cleaning out; third, in the evident inability of the ordinary flange joints to remain tight under these circumstances, since the excessive and repeated strains that they were subjected to under the variations of temperature to which they were exposed, gradually ground the cement to powder, and caused it to drop out from the joints. These formed very serious practical difficulties, and the problem presenting itself for solution, namely, the construction of an apparatus capable of raising the blast to a temperature of 600° Fah., and, at the same time, free from the above defects, must have been one involving most anxious considerations. An idea, however, at length occurred to Mr. Neilson, which approved itself to his mind, and has been the parent of all subsequent arrangements, namely, the cast-iron tubular oven.

The first practical realization of the cast-iron tubular oven is shown in Figs. 4 and 5, representing an oven erected at the Clyde Iron-works, in 1832. In this case, the irregular fire grates, five to two tuyeres, were done away with; and an oven, with one grate only, was constructed behind each of the tuyeres, now three in number; a tuyere, A, being at this time inserted at the back of the furnace, in addition to the two, one on each side, which were used before the introduction of hot-blast. In the oven

now constructed, the blast, instead of being carried as formerly, along one continuous heating-tube directly over the grate, was admitted into a main pipe, C, running longitudinally at one side of the grate, B; on the top of this main pipe, a number of deep circular sockets were cast with apertures into the pipe, and on the opposite side of the grate a similar main pipe, D, was fixed, with corresponding sockets and apertures, which was connected with the tuyere pipe inserted into the furnace. The two longitudinal main pipes, C and D, on each side of the grate, were then connected by cast-iron tubes, E, each forming a semi-circular arch of six feet span, fastened into the sockets with well-rammed iron cement. The cold-blast was supplied to each of the ovens by a branch-pipe taken direct off the large main from the blast-engine, and entered the oven at the end furthest from the grate. It then passed through the arched tubes, E, over the fire, into the pipe, D, on the other side of the grate, and thence to the tuyere, leaving the oven at the end next the grate. Whilst the blast was traversing the two longitudinal pipes and the arched connecting-tubes, it received the direct heat from the grate, and was raised by this means to a temperature of 600° Fah. The whole of the apparatus was enclosed in an arched oven, so as to retain and reverberate as much heat as possible.

On comparing this with the previous plan (Figs. 2 and 3), it will be observed that this apparatus, owing to its improved construction, maintained as efficient a temperature with less than two-thirds of the heating surface per tuyere, and little more than one-half the grate area. This oven was found to be a great improvement over the one previously described, raising the temperature with less expenditure of fuel, less leakage, and greater regularity. It is evident that, in this case, the defects inseparable from the former plan were, to a great extent, remedied; for the new apparatus was constructed without any great continuous length of pipe exposed to the direct action of the heat. The irregular action of the firing was materially diminished, each oven having its

own independent grate, and all flange joints were entirely excluded from within the oven.

The improved oven probably seemed perfect when first erected and set to work; but after a short experience of its working, objections were urged against it by the furnace-managers, on the grounds that, although the oven answered beautifully in respect to the temperature of blast produced, yet the socket joints would still sometimes leak, no matter how hard the cement was rammed in, that the arch tubes would crack over the grate, and that, unless the stoker was very careful in firing the oven, there was danger of burning the whole apparatus down when the fire was at all hastened, a case which happened once or twice. It was also objected that, owing to the proximity of the oven to the tuyere-house, it was at all times more difficult to attend to the tuyeres; and that, in the summer time, the workmen so engaged, being hemmed in on one side by the hot ashes from the furnace on drawing the tuyere, and on the other by the oven, found themselves literally roasted. At the present day, these difficulties might have been anticipated with such a construction of oven, but, at that time, must have been a source of great annoyance. Keeping in view, however, the points already gained in the arrangement of the oven, Mr. Neilson set to work to overcome the new difficulties thus brought to light, and produced an entirely new modification of the oven.

Up to this period the reference to the history of the hot-blast oven has been confined entirely to what has been done by Mr. Neilson and his friends in Scotland; but as it now approaches the point where the experience of the Staffordshire district and that of Scotland unite, it may be well here to glance at what had been accomplished in this immediate neighborhood up to the same time.

[To be continued.]

EGG-BEATER.

The annexed cut represents an egg-beater for which a patent was granted to Thomas McBean, of Fowlerville, N. Y., on May 24, 1859.

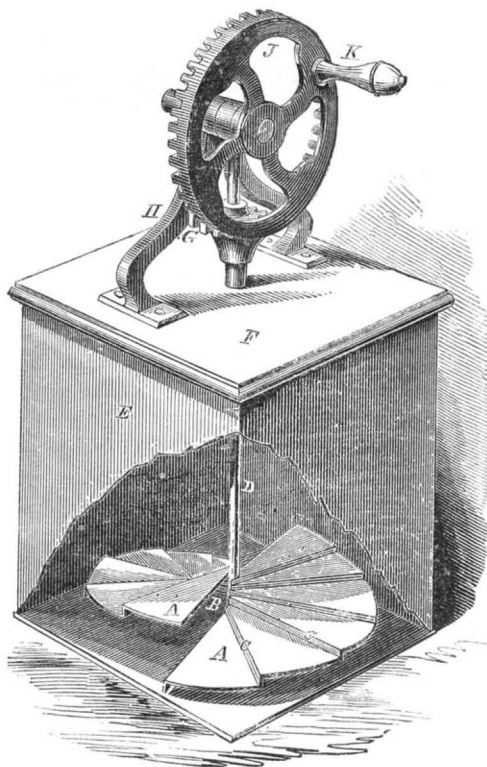

E, is a square box in which the beater is made to revolve rapidly by means of the handle, K, and the beveled gears, J and G. The beater is formed of the spiral circular plates, A, A, soldered to the small tube or cylinder, B; which plates are so bent as to form the steps, C, C. These steps are radial from the axis of motion of a vertical shaft, D, which shaft forms the axis of the pinion, G, and communicates the motion to the beater.

For further information in regard to this invention inquiries may be addressed to S. A. Heath & Co., Inventors' Exchange, No. 37 Park-row, New York.

About 40,000 tons of guano have been imported this year, which, at \$60 per ton, amounts to \$2,400,000.

TO KEEP GRAPES FRESH.

The following is a French method. Glass bottles are placed upon simple wooden racks about the outside of the fruit-room.

“Cut the bunch of grapes on the trellis at the end of the month of October, or even later, if it be possible. Let it be attached to a piece of the branch, including three or four joints below the bunch and two above. Put a little grafting wax on the upper end of this branch and introduce the lower end into a vial filled with water. The mouth of the vial may then be stopped with the wax. In order that the water may be kept unchanged, it is sufficient to add four grains of powdered charcoal to each vial. This addition keeps it pure during a whole year. It is not necessary to fill up the vials, the evaporation not lowering the level of the water more than two or three fractions of an inch in the space of six months. When the bunches of grapes are arranged as mentioned, we have nothing more to do than, from time to time, to cut away the berries that are rotten. It is essential that the temperature of the fruit-room should not descend below zero.”

The editor of the *American Farmer* says that this plan of preserving the grape may be very successfully practiced with other fruits ripening in autumn, though not with a probability of preserving them fresh quite so long as the grape. He has seen fruit of the Algiers winter peach kept fresh in a vial full of water, but unsealed, for a long time. The peaches, together with the leaves, were not detached from the twig. This is worthy of trial, and the time to put it into execution will soon be at hand.

STEAMBOAT DISASTERS.

The Louisville *Courier* gives the following list of accidents which occurred on the western waters during the first six months of this year (1859).

Boats snagged.....	22
Boats exploded.....	4
Boats burnt.....	26
Lost by collision.....	13
Lost by Rock Island bridge.....	1
Lost by running against bank.....	2
Boats foundered.....	3
Sunk by ice.....	2
Lost in storm.....	1
Total number of boats lost.....	74
Flatboats lost.....	36
Lives lost.....	337
Value of boats and cargoes.....	\$1,770,520

Were it not for such lists as these the public could form no adequate conception of the number of lives and amount of property annually lost by such casualties—no less than 674 lives sacrificed per annum. The greatest loss appear to have been caused by the burning of boats, no less than 26 being consumed; and next to this comes 22 sunk by snags. Does any one doubt the possibility of providing a remedy for most of these disasters? We do not; it is to be found in building the western steamboats of iron, in watertight compartments, and with very strong cells at the bows. Will our western boat-builders and engineers devote attention to this subject?

AID GRANTED BY THE STATE OF NEW YORK FOR INTERNAL IMPROVEMENTS.—The amount of money expended by the State of New York, for internal improvements, has been as follows:

For the New York Canals.....	\$8,401,403
For the enlargement of the Erie Canal.....	46,746,021
For the construction of the Internal Canals..	14,719,713
Total for the Canals.....	\$69,867,137
For the New York and Erie Railroad.....	\$3,000,000
For the Ithaca and Owego Railroad.....	315,200
For the Canajoharie and Catskill Railroad..	200,000
For the Hudson and Berkshire Railroad.....	150,000
Total.....	\$3,665,200

These sums granted to railroads have been either given outright, or have been lost by the failure of the railroad.

In addition the State loaned its credit to the following roads, which is either well secured, or has been repaid:

To the Tonawanda Railroad.....	\$100,000
To the Auburn and Syracuse Railroad.....	200,000
To the Long Island Railroad.....	100,000
To the Schenectady and Troy Railroad.....	100,000
To the Auburn and Rochester Railroad.....	200,000

Total..... \$700,000

HOOPER'S IMPROVED STEAM BOILER.

This boiler contains several valuable improvements tending to save fuel by creating a rapid circulation of the water, and to lessen the danger of an explosion for want of water, by contracting the evaporating surface towards the flues.

The former object is obtained by forming a water-circulating passage below, in rear and above the fire-box, and nearly or wholly isolating said passage from the fire-box by means of an open space existing between the walls of the fire-box and the partition walls of said water-circulating passage, whereby, after the boiler is supplied with water and the generation of steam is going on, the water passes upward from the hottest part of the fire-box to the passage above and to the rear, where it loses some of its heat, so that it rapidly descends through the passage behind the open space by reason of its superior gravity, and the draught or partial vacuum created near the fire or at the heating surface by the rising of the more intensely heated water causes the descending water to pass along through the lower isolated passage to the fire-box, where it mingles with the highly heated water surrounding the heating surfaces, and where it is again intensely heated so that it passes up and that it commences to circulate again as above described.

The other object of this invention is to lessen the danger of an explosion for want of water. This is obtained by contracting the boiler immediately above the fire-flues, that part of the same which is beyond or above and in the rear of the fire-box being widened, so that a sort of throat is formed and a greater depth of water over the fire-flues is obtained, even when the quality of water in the boiler is greatly lessened; and at the same time such a small generation of steam is accomplished, that the slow running of the machinery will give warning to the engineer that the water is getting low, while a free and perfect generation of steam is effected when the water is at the proper level by the more extended evaporating surface above said throat.

The boiler is represented in the accompanying engravings, in which Fig. 1 represents a longitudinal vertical section and Fig. 2 is a front view of the same.

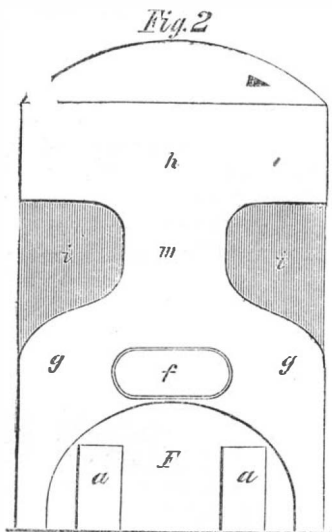

F represents the furnace, having the usual fire-doors, a. The back of the furnace is perforated for the reception of fire-flues or tubes, b, which conduct the products of combustion into the chamber, C, from which they are conducted by similar flues, d, into the chamber, E, and from thence by the smoke-pipe, f, into the chimney. A water-space, g, entirely surrounds the furnace and fire-flues. The upper part, h, of the boiler connects by the water passages, i and k, with the water-space, g. The upper part of the boiler may be connected with the water-space, g, by means of water tubes, l l. Immediately

above the fire-flues, d, the boiler is contracted so as to form a throat, m. When the water gets low a greater height of water is obtained over the flues and the evaporating surface is reduced, so that the danger of explosion from want of water is greatly reduced.

The passages, i and k, are separated from the fire-box by an open space, H.

The circulation of the water in this boiler is indicated by the arrows. It rises from the fire-box through the throat, m, to the evaporating surface, where some of it forms into steam. The rest passes through the upper part, h, of the boiler over the open space, H, where it is partially cooled, so that it sinks down through the passage, i, passing back to the water-space, g, by the passage, k. The water, which is thus kept in continuous circulation, takes up or absorbs the caloric much more

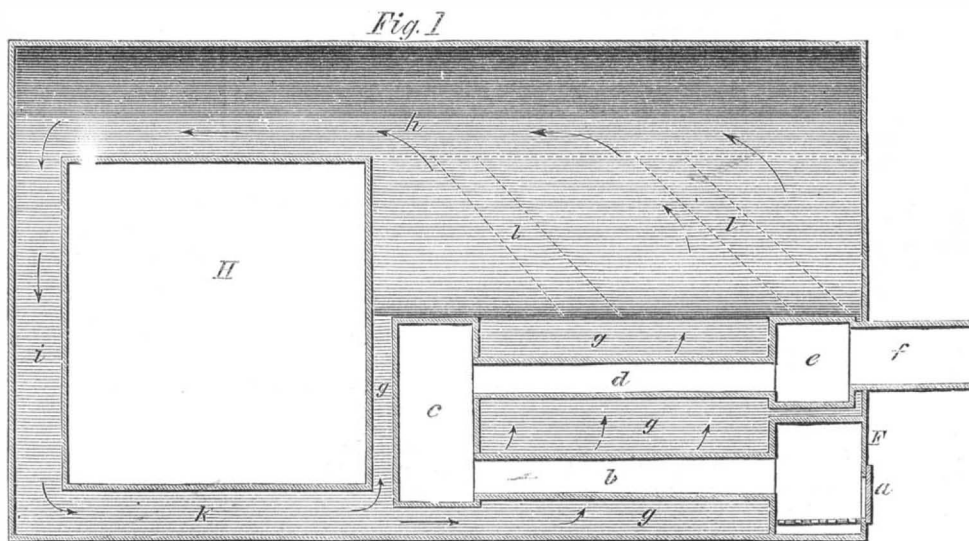

HOOPER'S IMPROVED STEAM BOILER.

rapidly, and consequently it forms into steam quicker and more economically than when kept in a state of rest.

The inventor of this steam boiler, Mr. Robert Hooper, will be happy to furnish any further information. He may be addressed at No. 16 Light-street, Baltimore, Md. He obtained a patent on his improvements August 9, 1859.

GRAIN AND RICE HULLING MACHINE.

We had the pleasure of examining, a few days ago, at the office of S. A. Heath & Co., No. 37 Park-row, this city, an invention for the above purpose, patented by T. F. Wagoner of Trenton, N. J., which seems to present some novel and useful features.

Its construction is quite simple, consisting of a stationary base-stone, through which a moveable spindle passes. A revolving rubber, or muller is secured to the spindle, and this is faced with india-rubber, vulcanized by a new process without sulphur. The peculiar adhesiveness and softness of the india-rubber adapts it, in a remarkable degree, to cleanse the seed or grain, at the same time polishing and beautifying it without injuring the form of the grain—a most important consideration. The rigidity of the materials heretofore employed in the construction of hulling and smut machines has been a serious difficulty, but the substitution of the rubber face upon the running muller seems to remove all objections, and produces a more perfect result, cleansing and preserving the grain in a most satisfactory manner. Considering the great amount and value of our rice crops, as well as those of buckwheat and other grains, the invention of Mr. Wagoner is likely to prove useful and valuable.

THE ILLINOIS STATE FAIR closed at Freeport on the 9th inst., and is report as a complete success. No less than 25,000 people were on the ground, and the receipts for a single day amounted to upwards of \$5,000. At the steam-plowing exhibition, on the 7th inst., Fawkes' machine (illustrated in our last number) plowed an acre in eleven minutes. The number of agricultural implements was larger than at any previous fair, which speaks well for the progress of invention in this department. The premiums awarded were extremely liberal, amounting to \$16,500. We expect to receive a full report from our special correspondent "Helix," in time for our next issue.

REAPING-MACHINE TRIAL—LETTER FROM MR. McCORMICK.

MESSRS. EDITORS:—I have just observed, in the SCIENTIFIC AMERICAN of the 3d inst., an error in your notice of the "great trial of reaping and mowing machines which recently took place at one of the royal farms in France," where "the Emperor awarded the prizes in person." You stated as follows:—"After a very few turns in the field, the contest lay between Burgess and Key's (Allen's Patent) and Wood's (stated to be Manny's Patent) reapers, in which the former took the lead, and was unanimously awarded the first prize; the latter the second." I herewith send you an extract from the "Paris Correspondence" of the *New York Tribune*, in regard to the trial referred to, the publication of which extract in your journal will correct the previous

error, and be only an act of justice to myself. I have also observed a similar error in recent Irish and English journals. The Paris letter-writer states:—"Three prizes were to be given to each class; a large gold medal, entitled the 'prize of honor,' was to be given (in addition) to the incontestably best machine among them all. This prize of honor, and the first of the three prizes for foreigners, were handed over to that very worthy American, Mr. McKenzie, who ran with the machine sent by Burgess & Key from London, which is the original McCormick reaper."

As may be inferred from the above extract, Burgess & Key, of London, are licensees and manufacturers of my reaping and mowing machine.

C. H. McC.

St. Nicholas Hotel, New York, Sept. 7, 1859.

[We have no doubt of the correctness of Mr. McCormick's statement. Our English exchanges have jumbled up the names of the machines with singular infelicity.—EDS.]

DIAL FOR DETERMINING THE VARIATION OF THE COMPASS.—We have before us a simple but very useful contrivance, the invention of Captain Toovey, of the mercantile marine, for determining the true variation of the compass. It is a simple dial, inscribed with an inner and an outer circle, having the quadrants and eight points of the compass worked off on each. In the center is fixed a gnomon, to the foot of which is attached a moveable hand that travels round the dial. This hand, in using the instrument, is made to indicate the direction of the ship's head, and her course. The dial is then placed in a horizontal position on the capstan-head, the ship's side, the poop-rail, or any other convenient place. The bearings of the sun are then ascertained, and the shadow cast by the gnomon indicates with accuracy the angle of variation of the compass, which is read off on the inner or outer circle with perfect ease. We may add that Captain Toovey has not patented this clever invention, his desire being that, if found to answer the purpose designed, it may be generally adopted in the service. The dial is fitted with a moveable sight for ascertaining the bearings of any object in the heavens or on the horizon.—*London Engineer*.

A CHANGEABLE CLIMATE.—The occurrence of a succession of very dry seasons in Texas has induced dispondency among the farmers of that State, as regards its future fruitfulness. Texas is a land of very variable weather. From 1742 to 1758, there were 15 very wet years, which were succeeded by three very dry seasons. From 1806 to 1813 there were six very dry years succeeded by seven very wet seasons. The number of wet and average seasons far exceeds that of those in which drouths were experienced; so it may be very reasonably predicted that the next year will be one of a very different character from the present in Texas, and that a luxuriant abundance will reign in 1860, where sterility is experienced in 1859.

IMPROVEMENT IN MAKING OIL OF VITRIOL.

The *Druggists' Circular* gives the following account of the large chemical works of Messrs. Tennant in Glasgow, Scotland, and of some improvement lately introduced in making sulphurated acid:—

"The magnitude of the works of this firm is exemplified not only by their size, and the great Tennant's stack (a tall chimney over 400 feet in height), but principally by the astonishing aptness and readiness with which the improvements of modern chemistry and mechanical arts are taken hold of.

"The whole establishment and its appliances compare only with the size of that monster chimney.

"A horse-railroad connects the different yards and buildings, and over the roofs another system of rails is laid, for the sole purpose of distributing the fuel in the various factories, by merely dumping the car containing it. A tunnel of not inconsiderable length, connects two of the main-works.

"The never-separable trio, oil of vitriol, soda, and chloride of lime, are sent from here in incredible quantities to all parts of the world. The quantity of oil of vitriol manufactured weekly reaches 600 tons, that of soda-ash 250, of sal soda 180, requiring about 450 tons of salt per week.

"Regarding their mode of manufacturing oil of vitriol, some very remarkable improvements have been introduced. Instead of the nitric acid or saltpeter formerly used, they employ nitrous acid, dissolved in oil of vitriol. The latter possesses the quality when of a specific gravity above 1.75, to absorb nitrous acid, and to give it off on dilution with water. On top of the first lead chamber, of each system of six, are placed two large leaden vats, of which one contains the solution of nitrous acid, the other water. From each a siphon reaches into the chamber where they connect, thus setting free the nitrous acid. This by giving off one atom of oxygen oxydizes, the sulphurous acid which is present in gas-form, is again oxydized by the atmospheric air passing through the chamber, and would never require to be renewed, if some portion were not constantly carried off by the draught. It has however been found from the quantity of nitrate of soda, that this process of loss and gain of oxygen repeats itself with nitrous acid about 132 times before the original quantity is entirely lost. The gases, as they are escaping from the lead chambers, are made to pass through a tower filled with coke in small lumps, over which sulphuric acid is running in a thin stream from above. In this manner about one half of the nitrous acid is regained. The nitrous acid is obtained at Tennant's by a peculiar method. A mixture of 3 equivalents or about that proportion of sulphuric acid, one of nitrate of soda, and two of chloride of sodium form by distillation three equivalents of sulphate of soda, one of nitrous acid and two of chlorine. That is, instead of obtaining and using nitric acid, as others do, for the oxydation of the sulphurous gas, Tennant takes advantage of the two atoms of oxygen, which are of no use in the lead-chamber, in such a way as to obtain two equivalents of chlorine gas in their place.

"The apparatus for this double decomposition consists of cast-iron cylinders, from six to seven feet long, and from seven to eight in diameter, placed horizontal in furnaces. They are charged at the front with the salts and by a funnel at the top with oil of vitriol. The gases evolved are passed a through system of lead vessels filled with sulphuric acid, which absorbs the nitrous acid while the purified chlorine passes on to the chloride of lime-chambers.

"This chlorine, of course, furnishes but a portion of the quantities manufactured at the works. The greater portion is evolved in square stone vats from black oxyd of manganese and muriatic acid, heated by steam on the outside. One of the greatest improvements made in this manufactory is the regeneration of the binoxyd of manganese from the crude solution of chloride obtained in these stone vats. The liquor is run off into cisterns where it allowed to settle. It consists principally of an acid solution of chloride of manganese, of some per-chloride of iron and alkaline earths. These latter oxyds are precipitated by chalk or lime, which are added in just sufficient quantity. The thus-neutralized and purified chloride of manganese is then pumped by a wheel into large pans where it is mixed with whiting, and the milk thus produced transferred to a colossal cast-iron pan, nine feet wide and 80 long. Through the whole

length of this pan a hollow stirring shaft works by means of a power at each end. When the machinery is set working high pressure steam enters the mixture through apertures in the shaft, and by the action of this and the chalk combined, all chloride of manganese is converted into carbonate of the protoxyd. The mixture of chloride of calcium and carbonate of manganese is thoroughly washed and stirred in similar pans of sheet-iron, 100 feet long, and eight feet wide, by the same stirring-apparatus. When pure the carbonate of manganese is thrown on heaps, to rid it of most of the moisture, and when sufficiently dry it is placed into flat iron-dishes, and these again into a furnace where they run up and down on an endless chain at a temperature never exceeding 300° Fah.

The water and carbonic acid being driven off, the protoxyd gradually oxydizes in the slow heat of the furnace, which for that purpose admits some air. If a higher temperature be applied the product would again lose oxygen and form sesquioxid. The dark brown oxyd obtained by the above process is almost pure, and contains from 73 to 90 per cent of pure binoxyd.

PHOSPHORESCENCE.

At a late meeting of the American Photographic Society, in this city, a paper was read by S. O. Tillman, A. M. (since published in the *Journal of Photography*), on photo-phosphorescence, which elicited considerable discussion, and regarding which the president (Professor Draper) made the following remarks:—

"I have made many experiments on phosphorescence; it is a subject which has engaged my attention for many years. I only mention a fact or two which may be found to have some bearing on the question of stored-up light. If the powder of sulphide of calcium be spread on some convenient surface, as a sheet of tin, and upon this a key be laid and the whole be exposed for a few minutes to the sunlight, on bringing it in a dark room and removing the key, the whole surface will shine, except where the key left its shadow. The image of the key will appear black on a white ground. The phosphorescent light, however, gradually diminishes till the image of the key cannot be distinguished. If now a ring be laid on the powder, and the surface be again exposed to sunlight, in the dark the image of the ring will appear and disappear. The experiment may be continued with other objects, and with precisely similar results. So far you find nothing that you did not know or might easily anticipate. But now heat the plate in the dark, and the images of the key and ring, and other objects, will reappear. These images were impressed, for a considerable time were latent, and again they are developed. A phosphorescent which has lost its power to shine in the dark, recovers this power when a spark of electricity is sent through it. The light now given out passes readily through quartz, while glass is opaque to it. I have examined a great many diamonds in the study of phosphorescence. I have observed that yellow diamonds are invariably phosphorescent, and shine with brighter light than others. If after the diamond has ceased to shine in the dark, it be warmed in the hand, it glows again, but only for a short time; this property may be restored successively at increasing temperatures."

NEW YORK ARTIFICIAL RIVER.

Before the era of railroads, the Erie Canal conferred very superior advantages upon New York, for communication with the great West. Things, however, have undergone a great change since the iron road and the iron horse have been introduced, as these have afforded facilities for communion with the West, by Pennsylvania and other routes equal to those of New York. Much of the inland traffic, therefore, has of late years been diverted from old channels, and our merchants and those who are interested in our canals have become greatly alarmed, and have lately met at Rochester, N. Y., to concoct measures for, and urge the enlargement of the Erie Canal, so as to improve its capacity for larger boats, especially steamers. The Chamber of Commerce of this city has also published a report and resolutions, urging this improvement; and a very strong influence seems to be exerted among various parties and classes to accomplish this object, so as to make this canal like a river of moderate depth, for floating boats that shall be capable of carrying heavy freight and large cargoes, at a small cost. According to the mode in which most of our railroads have hitherto been managed, such a canal improve-

ment would defy their competition, and those who are now actively engaged to bring about such results seem to have looked somewhat deep into the subject. While we acknowledge this, we cannot overlook the fact that our railroads are but in their infancy, and thus far they have received but very indifferent nursing. With improvements, by new inventions and superior management, we consider that it is not unreasonable to expect that a great revolution will yet be effected in our railroads, and that twenty years hence, they will be operated at one-half the cost now incurred for doing any fixed amount of work.

HOW THE PYRAMIDS WERE BUILT.

A correspondent suggests that the mode by which the stones used in building the pyramids of Egypt were raised to their places was by piling up immense inclined planes of sand, up which the blocks were pushed on rollers. The statement, often repeated, on high authority, that the pyramids were built before the Egyptians acquired the art of writing hieroglyphics, proves, on closer examination, to be erroneous. The few hieroglyphics, however, which they do contain, do not convey that full knowledge of the state of the arts among them, at the time the pyramids were constructed, which is to be learned from the writings and pictures in their tombs and temples, in regard to the state of their arts at a subsequent period. But we have the less valuable authority of Herodotus, that the blocks of stone were lifted from one course to the other, up the steps of the pyramid. Remains of Cheops' grand causeway, for transporting the blocks quarried from the rocks on the east bank, are still seen leading up to the great pyramid from the plain—a shapeless ridge of ruinous masonry and sand. According to Herodotus, it was 1,000 yards long, 60 feet wide, and 48 feet high, was adorned with figures of animals, and was a work of ten years. Some of the stones used for the coping over the passages, are seven feet thick, and more than seventeen feet long. Lifting these stones up the sides of a pyramid 450 feet high, was certainly a work of great labor, but as a feat of engineering, it was mere child's play, compared with some of the triumphs of modern science and skill—for instance, lifting the Menai bridge on to its piers, or raising on end, and placing on to its pedestal, the monstrous monolith which adorns the city of St. Petersburg.

ROOFING THE VICTORIA BRIDGE.

This, the greatest tubular bridge in the world, is now being roofed with tin plates. The *Montreal Herald* gives a brief description of this operation, as follows:—

"About ten plates are soldered together, and by a peculiar process are nailed by strips of tin to the roof, having previously been tapped by ridges to corresponding strips of soldered plates. These ridges, about one inch high, extend from the top to the bottom or edge of the roof, and are so constructed that they expand or contract with the tubes upon which they rest. Another peculiarity in the process is that they are perfectly water-tight, not a lap or nail being seen over the whole extent of the roof. Mr. Martineau (the contractor) will use about 1,400 boxes, each box containing 112 plates. A great number of tradesmen, many from the United States, tendered for the work; but the report of the engineers, after witnessing the peculiar advantages of the 'standing groove' roof, awarded the undertaking to Mr. Martineau."

A small locomotive is used for carrying the plates to the workmen, a great number of whom are busily engaged, so as to get through with the roofing at an early date.

CANADIAN LUMBER.—No where in the whole of America will you see such magnificent and valuable rafts of lumber as on the Ottawa. Those on the Delaware, Ohio and Mississippi are not to be compared to them, either in size or in the value of the wood of which they are composed. Far back in Canadian woods the logs are cut in winter time; in spring they find their way singly down tributary streams to the Ottawa, where they are bound together into rafts and floated down to Quebec, or they are worked-up by the magnificent saw-mills along the valley, which cut up over 200,000 logs per season. An interesting feature in the lumber transport are the timber-slides—an ingenious piece of engineering for the purpose of getting the logs over the rapids. On the construction of these, the government has already spent something like \$500,000.

MANUFACTURE OF THE OTTO OF ROSES.

The following is an interesting article on the manufacture of this celebrated perfume, by Dr. J. Lawrence Smith, Professor of Chemistry in the University of Louisville, Ky., and written for the *American Journal of Pharmacy* :—

"Seeing an article in the May number of the *Journal*, on the otto of roses, it brought to my recollections some neglected notes made during my residence in Turkey, on the culture of the rose and the extraction of its oil, at Kisanlik, in the Balkan Mountains.

"The region where the rose is cultivated is a valley in the Balkan Mountains, in which is situated the city of Kisanlik, about 60 miles north-west of Adrianople, in lat. 42° 40'. It is only within 14 or 15 years that the cultivation of the rose has taken its present development in that region, although, for a number of years, the otto has been made there in limited quantity, especially for royal presents. The surface of the country is that of an extensive plain, shut in by elevated ridges, and here the rose is cultivated by the farmers, who sell the roses to the distillers residing in Kisanlik, seldom or never distilling them on their farms. The rose cultivated is of one kind (a full red rose), that was doubtless introduced into this region many years ago, and selected for its great fragrance and peculiar adaptation to the distillation of the oil. Its cultivation is attended with but little trouble. The bushes are allowed to grow from four to six feet high, although sometimes much higher.

"The roses are gathered during the months of May and June, six weeks being the term usually occupied in getting the crop; the yield is, on an average, about one and a half pounds of rose leaves to a bush, the roses being collected with the calyx. They are gathered half expanded, and at the dawn of day, and not unfrequently before daylight; they cannot be kept advantageously more than a day before being put into the still. If obliged to do so, they must be turned over frequently, as otherwise they will ferment, heat, and the otto will be lost.

"The roses are placed in copper stills of about 30 gallons capacity, in proportion of 60 pounds of rose leaves to 15 gallons of water, and the still immediately heated. The oil is in the first portion of the water which comes over, which is collected in several large bottles; this water is now placed in a second still, and about one-fifth of it distilled, on which all the oil will float. The oil is taken off the surface with a little spoon, and placed in an appropriate vessel. All the water distilled in both the first and second operation is sent into the market as rose-water; the water remaining in the still with the leaves is strained off, and added to a fresh portion of the leaves, in the proportion already mentioned.

"The quantity of roseleaves required to produce one metical (one and a half drachms) of the oil varies from 30 to 60 pounds, according to the nature of the weather. If the roses open during wet weather, and flower slowly, the yield is at its maximum; if, however, the weather is hot, and the bush flowers vigorously, the yield diminishes, the rose itself is paler, and, if not picked at an early stage, yields almost nothing. There is a green wax that comes off the calyx (attaching itself to the fingers of those collecting) that also yields an oil by distillation.

"The annual product of otto of roses in this region is from 28,000 to 30,000 ounces, although so largely is it adulterated, that the amount of oil exported is upwards of 70,000 ounces. The material employed for adulteration is the oil of a species of geranium (very probably the *Pelargonium roseum*), grown in Arabia, in the neighborhood of Mecca, and taken to Kisanlik for the purpose of adulterating the otto of roses; this geranium oil has the odor of the rose mixed with that of the lemon. In fact, it is a common thing, both in Europe and this country, to find this geranium oil in market, called otto of roses, sometimes mixed with a little spermaceti and benzoic acid. On one occasion, a merchant at Constantinople told me that he sent large quantities of oil of geranium to parties in New York, who informed him, through his agents in Smyrna, that it sold very readily in this country as otto of roses, and that the difference was not appreciated. It is almost impossible to obtain the oil of roses pure; the distiller hardly gets his oil together in the evening before he commences to elongate it by a little geranium oil; if it be only five per cent., he must put that in. Such small additions as that would be

made only by *very conscientious traders*; 50 to 200 per cent. are far more commonly added. And, should the otto happen to sojourn a little while at Constantinople, it would increase still farther in weight and bulk. In bazaars of that city, three or four grades of the otto can be bought. Of course, they are simply different degrees of adulteration.

"The exact cost of manufacturing the pure otto of roses at Kisanlik, may be estimated by referring to the following figures of an actual experiment made under my direction :—

10,000 lbs. fresh rose leaves.....	\$140.00
Paid for use of still.....	6.25
Paid for labor and fuel.....	16.50
Total.....	\$162.75

"The yield was 36 ounces, thus costing \$4.52 per ounce to the producer.

"This fragrant oil is made in other parts of the world by processes differing, doubtlessly, from the one described; also, from a different rose. The one used in Tripoli is white, having but few petals; the rose grown in the southern portion of France, bordering on Italy, yields hardly a trace of oil by distillation, although only one-half a degree further north than Kisanlik; the rose leaves there being used directly to impart their odor to perfuming soaps or distilled water.

"As regards the manner of testing the purity of the oil, sulphuric acids and other tests are of no value. The odor is the best test, and that can only be applied by experts where the otto is made."

SAFETY FOR STEAMBOATS.

Messrs. Editors:—I submit the following plan for securing steamboats against destruction by fire: let iron pipes be laid to connect with the engine and every part of the boat, say one or two main pipes with branches. To the end of each branch a short piece of hose and a nozzle should be attached, and a stop-cock to shut off and let out the water. In case of fire, a bell, communicating with the engine-room, should be struck; and by this signal the whole power of the engine applied to work one or more huge pumps to throw a vast body of water into the main pipes, thence to be ejected directly on the fire by one or more of the branches. No steamboat, with her engine in working order, should be permitted to burn up until the river, lake or ocean, as the case may be, is first pumped dry. Let this arrangement be universally applied to steamboats, for life and property are of paramount importance.

HENRY A. TRENCH.

Grand Ledge, Mich., Sept. 3, 1859.

[Except in the *minutes* of detail, this plan of our correspondent, for insuring the safety of steamboats, is already in use on several. It is not so generally applied, however, as it ought to be; the public attention, therefore, deserves to be more fully directed to its importance.—Eds.

TO CLEANSE WOOL FOR HOME USE.

A correspondent of the *Rural New Yorker* furnishes the following receipt for cleansing wool, which may benefit our readers:—

"Two pails of rain water; one of urine; one pint of salt, heat all to scalding heat. Put in the wool, stir with a stick, and let it remain for about thirty minutes. Take it out with a stick, and lay on a board to drain. Have the board so arranged on the side of the tub or kettle that the liquor will run back in the same. After the first kettle-full is taken out, add more water, urine and salt, to keep up the strength of the liquor, and proceed as before. The longer the liquor is used the better. Soft soap, or lye from ashes, will answer in the place of urine, or may be used with them. The liquor must be strong enough to dissolve the gum or oil on the wool, so as to rinse off clean. It is of no benefit to pick."

By leaving out the salt in the above liquor, it will be found very useful for the purpose. The addition of the salt is like mixing it with rain water for the purpose of improving its quality in the washing of clothes.

IRON CHURCH SPIRE.—An iron spire is about to be erected on a church in Pittsburgh. This will be the first construction of the kind in the United States, and it is fitting that it should be put up in the "Iron City." This church has now a brick tower 100 feet high, which is to be carried up almost as high again, by erecting upon it a beautiful cast-iron spire, 85 feet high, exclusive of the cross that will crown the apex. The style is to be the perforated Gothic of the Middle Ages.

A COLUMN OF INTERESTING VARIETIES.

Philosophers regard it as demonstrated that, even in the most solid substances—gold, for instance—the particles do not touch each other. This inference is drawn from the fact that the metal shrinks in cooling. They say if the particles were already in contact, they could not come any closer together; and, consequently, the metal could not shrink.....Before the whites went to California, the principal articles of food among the Digger Indians was grasshoppers and acorns. They caught the grasshoppers in square holes, which they dug in the ground, and pounded them into a paste, which they dried into a hard cake; the acorns they pounded and mixed with water in a porridge, which they cooked in water-tight baskets, by putting in hot stones.....The reputation of American cutlery is now so fully established that some of the cutlery made in Sheffield, England, for this market, is stamped with the names of American manufacturers, in order to facilitate its sale.....The dress of the women among the Digger Indians of California, in their wild state, consists of a bunch of grass tied around their waists and falling down to their knees.....When Lieut. Berryman was sounding the ocean, preparatory to laying the Atlantic Telegraph, the quill at the end of the sounding-line brought up a mud which, on being dried, became a powder so fine that, on rubbing it between the thumb and finger, it disappeared in the crevices of the skin. On placing this dust under the microscope, it was discerned to consist of millions of perfect shells, each of which had been the abode of a living animal. These have been sinking down through the water to the bottom, and will no doubt form, in the course of ages, an extensive range of either silicious or limestone rock. The process is similar to the one by which stratified rocks were formed in ancient geologic periods.....It is reported that Stevenson, the celebrated English engineer, received \$225,000 for the plan of the Victoria Bridge, at Montreal.....A telegraphic message was recently sent from Albany to Kansas City, and an answer received, in the short space of six hours!.....The amount of money exchanged by the New York City banks, for the week ending the 5th instant, was \$120,568,395, an average each day of \$20,094,629.....The wine crop of Ohio, for the present year, is estimated at over \$1,000,000 in value. Within 20 miles around Cincinnati, the crop is estimated at 800,000 gallons. Our trans-atlantic friends will thus see that the production of wine in this country is becoming a vast interest. Among the papers published in costly style, by the Smithsonian Institute, at Washington, is one on microscopic plants and animals which live on and in the human body. It describes quite a number of insects. The animal which produces the disease called the "itch" is illustrated by an engraving about half an inch in diameter, which shows not only the ugly little fellow's body and legs, but his very toes, although the animal himself is entirely invisible to the naked eye.....Twenty-eight and a half lbs. of pure lime consist of 8 lbs. of oxygen, and 20½ lbs. of the metal calcium.....The battle of Flodden, on which Scott's poem, "Marmion," is founded, was fought on the 9th of September, 1513, in the reign of Henry VIII., of England, and James IV., of Scotland. The Scotch king was killed in the battle, with a multitude of the highest rank among the nobility and gentry of the kingdom.....In looking at the most distant stars, we see them, not in the places and condition in which they are at the present time, but as they were several years ago, when the light by which we see them started from them on its long journey to the earth. We are looking, in fact, upon their past history.....The engineer of the great tunnel (nearly nine miles in length) which is in process of being excavated through the Alps, has adopted a plan for working the drills by power, which is said to have succeeded admirably. By a water-power at the mouth of the tunnel, he forces air through a pipe into the tunnel where the operatives are at work; here it is used to drive small portable engines, which work the drills. By this plan, he avoids the smoke and steam which, of course, would be inadmissible in so confined a place; and the air, as it escapes from the engine, ventilates the tunnel, furnishing a fresh supply for the workmen to breathe.....The sun, with all the planets and satellites which revolve around him, the whole solar system, is sweeping along through space in a direction towards the constellation, Hercules.

SUGAR-CANE MILLS.

Among the various devices for crushing sugar-cane which have been presented, from time to time, to the readers of the *SCIENTIFIC AMERICAN*, the mill represented in the accompanying engraving ranks as one of the cheapest, most compact, and simplest arrangements ever devised for this purpose.

Our engraving represents a perspective view of this mill, which consists of a frame, A, of cast-iron, firmly bolted down to a suitable bed or foundation, B. This frame forms the bearings for three rollers, C D E, that are arranged in a horizontal position, and in such a manner that the distance between the rollers, C and D, is somewhat larger than that between the rollers C and E, whereby the cane that enters between and is partly crushed by the first pair of rollers, C and D, is completely freed from juice as it passes through the second pair. The journal-boxes, a, of the roller, C, are adjustable; so, however, that the ratio between the distances of said roller from the other rollers is preserved.

The roller D is smaller than the two other rollers, so as to save weight, the velocity of its surface being the same as that of the two other rollers. Its axle extends beyond the frame, A, and it bears a bevel wheel, F, that gears into a large horizontal wheel, G, which is provided with two loops or eyes, b, to receive a sweep, H, to which a horse may be hitched, so as to give motion to the mill.

The wheel, G, is mounted on a vertical arbor, c, that has its bearings in lugs, d, which are secured or cast with the frame, A, and on that side of the same which is opposite the bevel wheel, F. By this arrangement, the whole mill is brought into a very small compass, not taking more room than is actually covered by the wheel, G.

To prevent the two wheels, F and G, getting out of gear, a forked arm, I, is placed loosely on the end of the axle of the roller, D. This arm carries two friction rollers, e, that bear down on the upper surface of the wheel, G, so that the arm, I, exerts a double strain, keeping the axle of the roller, D, up, and the wheel, G, down.

The juice squeezed from the cane is collected in a trough, J, in the lower part of the frame, A, and from this trough it flows to buckets placed on the side of the bed, B.

The inventor of this mill, E. J. Horn, of Addison, N. Y., has applied for a patent on the same, and he will be happy to give any desired information in regard to it. Mr. H. also manufactures the mill extensively, and can furnish sizes costing from \$15 to \$50.

THE OLD EARTH.

In some places, the chalk cliffs of England are a thousand feet thick, and below this is a bed of rocks of a different kind, another thousand feet in thickness, crowded, as well as the chalk, with the remains of marine animals. Beneath this whole two thousand feet there is another rock full of drift-wood, fresh-water shells, and the remains of venomous lizards, resembling crocodiles, all so deposited as to show that this rock was

formed at the mouth of a great river, like the Nile or Mississippi. No doubt, after this river had long rolled its course over that part of the world which is now the north of Europe, the land slowly settled down beneath the sea, as Greenland is now settling, where it remained through the unmeasured ages required to form the whole two thousand feet of rock which now rests upon

AN EXTENSIVE ORDER.—Along with our last regular issue we published a full and complete account of one branch of the india-rubber manufacture, as carried on by the "New York Belting and Packing Company." As a specimen of illustrated newspaper-work, it will generally be conceded that it has never been excelled in this country. The company whose interests it represented were so much pleased with its appearance, that they promptly ordered *twenty thousand extra copies* to be printed for their own circulation. Without the aid of the electrotyping art, we could not have filled so large an order.

IMPROVED BROADCAST SEEDING MACHINE.

The line in which American genius has most unquestionably and completely outstripped all other nations, is in the invention of agricultural implements. The mind of the nation is teeming with new devices for aiding the labors of the farmer, and thus increasing the productive power of the country. The combined seeding machine and harrow which is represented in our illustration is curious from the amount of ingenuity expended upon it, and we should think it a useful improvement.

A represents an axle, B B, its wheels, and C, a draft-pole which is attached to the axle by means of a bent bar which passes around in front of the machine, and is fastened to the axle near the wheels. The seat, F, is supported from the axle by an elastic plate. To the back end of the draft-pole, by means of a swivel-joint, a revolving harrow, H, is attached, the teeth of which are set

HORN'S IMPROVED SUGAR-CANE CRUSHER.

it, from the remains of marine animals, in the same way that rock is now forming along the telegraphic plateau; after which the whole was slowly heaved up above the sea by the force of the internal fires of the earth, as Sweden, Norway and Chili are being elevated

at an angle to as to cause the harrow to revolve as it is dragged over the ground. On the front portion of the bent bar which connects the draft-pole with the axle, a seed box, I, is placed, of a length equal to the diameter of the harrow. The bottom of this seed box is perforated by a series of rectangular holes, and a slide, somewhat shorter than the box, perforated with similar holes, is placed over the bottom in such a manner that it may be slipped by means of the handle, N, and the size of the openings, and consequently the delivery of the grain, be thus adjusted. The grain falls through the openings in the bottom of the box, I, into the upper apartment of the lower box, J, Fig. 2; here it is stopped by a slide, as shown in the cut, which slide is pressed against the sloping bottom of the box by means of a spring. This slide is firmly fastened to an arm which works on a joint, p. A projection from this arm rests upon the cam, r, in such a way that each projection or tooth of the cam, as it revolves, raises the slide, thus gradually feeding the grain from the upper to the lower apartment of the box, J. The lower part of the box, J, is rounded in a semi-cylindrical form, and in this a toothed wheel, extending

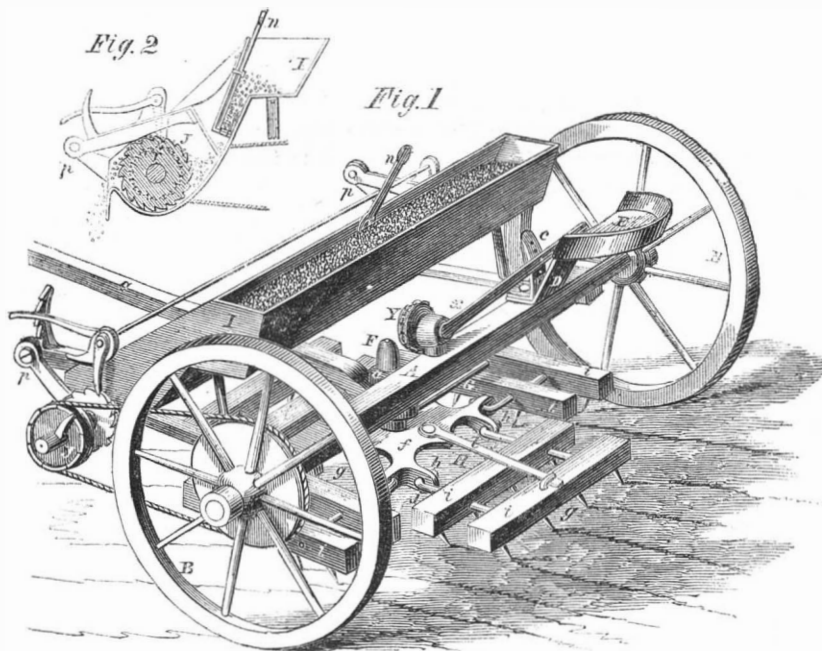
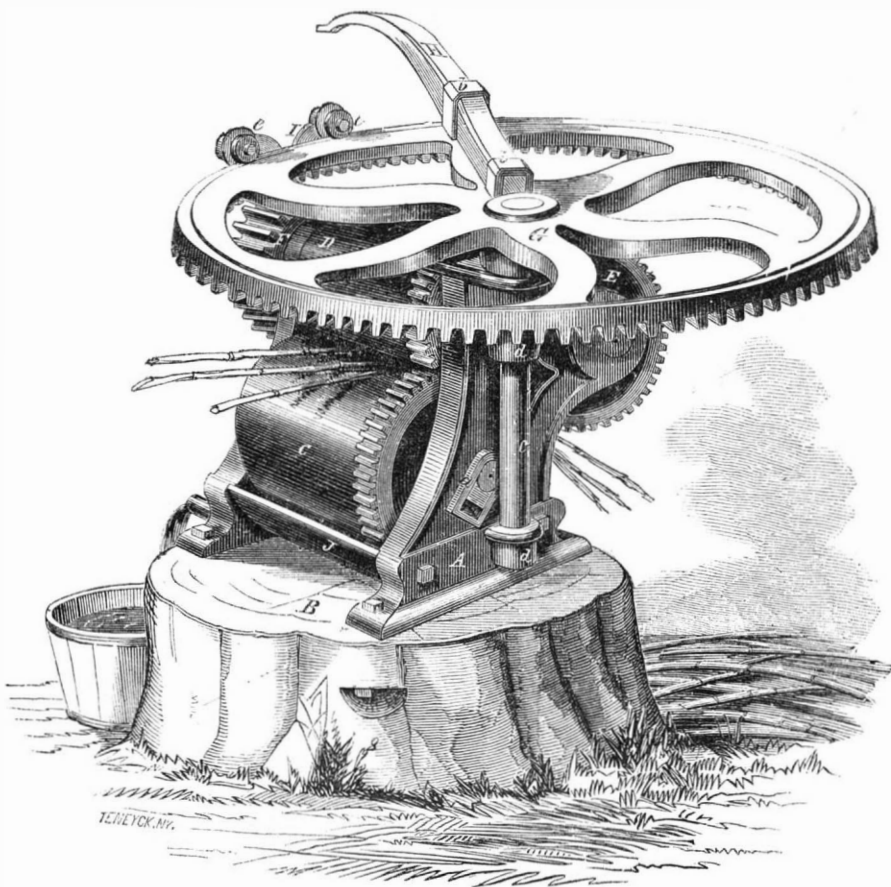

HUNTER'S BROADCAST SEEDING MACHINE.

at the present day. The earth, without form and void, was in existence millions of years before man was created as recorded in the Bible.

Messrs. Hoe & Co., of this city, have just shipped one of their six-cylinder printing-presses to Sydney, Australia, and have sent out one of their best men to superintend its erection.

The whole length of the box, revolves, carrying up the grain over the top of the wheel, and dropping it out in front of the machine. The revolving harrows then harrow the grain in, and the whole operation is completed.

For further particulars address the inventor, Stephen R. Hunter, Cortlandt, N. Y. The implement was patented April 26, 1859.

Scientific American.

MUNN & COMPANY, Editors and Proprietors.

PUBLISHED WEEKLY

At No. 37 Park-row (Park Building), New York.

O. D. MUNN, S. H. WALES, A. E. BEACH.

TERMS—Two Dollars per annum.—One Dollar in advance, and the remainder in six months.

Single copies of the paper are on sale at the office of publication, and at all the periodical stores in the United States and Canada. Sampson Low, Son & Co., the American Booksellers, No. 47 Ludgate Hill, London, England, are the British Agents to receive subscriptions for the SCIENTIFIC AMERICAN.

See Prospectus on last page. No Traveling Agents employed.

VOL. I., No. 12.....[NEW SERIES.].....Fifteenth Year.

NEW YORK, SATURDAY, SEPTEMBER 17, 1859.

NAVIGATING THE AIR.



SINCE the time when the first balloon ascension was made at Paris, in 1783, the interest in aerial navigation has been periodically revived. We are now in the midst of one of these revivals.

Two different systems of navigating the air have engaged the attention of inventors. One of the plans is to carry up, by means of a balloon, an engine which will work a propeller, and thus drive the balloon through the air. The other plan is to dispense with all buoyant power, and to rise and move through the air by the simple power of the engine beating the air, as a bird does in flying. The first of these methods is practicable, to a certain limited extent, in the present state of the arts. Balloons have been made capable of carrying up 1,700 lbs. There is no difficulty in making a steam-engine which, with its boiler, water, &c., and a moderate supply of fuel, would weigh less than 1,700 lbs. Such an engine, if properly attached to a suitable propeller, would move the balloon through the air. But a balloon, to support such a weight, requires to be so very large, and, consequently, the resistance of the air would be so great, that the motion through the air would be exceedingly slow. As the currents of air move with great velocity, the balloon would move mainly with them, and would be almost as much at the mercy of the winds as a balloon without any steam-engine attached. Of course, the resistance of the air would be more readily overcome by making the balloon pointed at the ends, or, as it is technically termed, of the cigar shape. Still, the weight of a steam-engine is so great in proportion to its power, and a balloon requires to be so large, even to support the weight of a man, that we have no faith in the idea of navigating the air, to any useful purpose, by means of balloons and steam-engines.

In regard to the other method of flying by the simple power of the machine, the problem reduces itself to the production of a machine which shall have a certain power in proportion to its weight. If we can get a machine which shall have the same power, in proportion to its weight, as the muscular power of a bird is in proportion to its weight, the machine can be made to fly. This proportion would have to be enormously greater than it is in the steam-engine, or any other engine at present known. It does not seem very probable that the thing will ever be accomplished; still, there is nothing to justify us in asserting, positively, that it never will be. A person who considers the past triumphs of science and skill is slow to affirm that anything cannot be done, unless it is physically impossible. We can conceive of a power being produced by gas generated by chemical decomposition, so as to dispense with a boiler. If such a power could be applied to driving an engine, by using a rotary engine and running it with great velocity, we should have a large power in proportion to the weight of the material; perhaps large enough to enable us to fly. At all events this is the point to which inventors who wish to navigate the air must direct their attention. No contrivance of wings and straps and pulleys and springs will enable a man to fly by means of muscular power, or by means of any of the engines at present in use. If this problem could be solved so that we could fly with as much facility as a bird does, it would furnish us with the most perfect of all modes of locomotion.

RICHARD COBDEN & AMERICAN MECHANICS.

High birth and great wealth place men in elevated positions, but they do not make them truly great, or honorable men. The man who, perhaps, exerted more political influence than any other personage in Europe during the last 30 years, was Sir Robert Peel, the calico-printer. The Corn Laws of England, which were enacted to conserve the interests of the nobles and large landed proprietors at the expense of the manufacturers and mechanics, were abolished through his influence while he was prime minister, after they had existed for half a century. The triumph which was thus achieved, he candidly acknowledged, was in a great measure due to the labors and light thrown upon the question by Richard Cobden, another calico-printer. This gentleman visited our country last winter, examined closely the working of our institutions, and returned home very favorably impressed with our country and people. To the credit of his countrymen, who esteemed him highly on account of his honesty and ability, he was elected to represent the constituency of Rochdale, while absent in America, a voluntary act on their part, as the position was unsolicited by him. On his return home last month, they gave him a grand entertainment at which there were several thousand persons present; and upon that occasion he made a speech which contained some remarks so complimentary to our mechanics that we cannot forbear publishing some of them. As a reformer he is also an advocate for voting by ballot in electing representatives to the House of Commons, and it was while discussing this question that he said:—

"I will mention one illustrative fact which I acquired in America on this subject. Now, understand, I am not going to quote America as a country where you should go for imitation in everything regarding her political institutions, which are as unfit for us in some respects as ours would be unfit for them. But this I may say, in passing, that the white men of the United States have a theory of government which they have laid down in their institutions, which, if the human instrument be equal to the political machine, means to deal justly and fairly by every man in their community. But now I confine myself to one fact that was given to me in my travels in America. I was speaking to a gentleman—whose letter I may read, for it is in but few words—whose name (Mr. Randall) is known to some of our statesmen here, for I remember he gave evidence before a committee of the House of Commons upon which I sat to inquire into the mode of proceeding of our Houses of Parliament, in order to furnish information as to the rule of the Congress of the United States. He is a man standing high, both socially and politically. He mentioned this fact in conversation with me, and wishing that I should have the full benefit of the information under his own signature, he wrote me a letter after I left Philadelphia, where the gentleman lives (and I shall take care to have it published), addressed to me at Washington. It contains these lines: 'I have been for fifty years connected with political and party movements in Philadelphia, and I never knew a vote bought or sold.' That is one of the largest cities in America, and contains one of the largest populations of mechanics and workmen, for Philadelphia has changed its character from being as it formerly was a leading seaport, and has become almost entirely a manufacturing city, with 600,000 or 700,000 inhabitants."

For quite a number of years Richard Cobden was under the ban of the aristocratic politicians in Parliament, because, while they despised him for his comparative poverty, they were envious and jealous of his mental powers, and he was thus shut out from office, while men of far less ability were put in. The honest *right* however has triumphed at last; he was offered a seat in the present Cabinet with Lord Palmerston, which he refused, and he is now an independent member of Parliament, unshackled with office and aristocratic connections, so that he can advocate the rights of the people with a warm heart and "clean hands."

HARD INDIA-RUBBER.

The long-disputed question is settled at last! "There is nothing like—india-rubber." Having given, last week, a description of the manufacture of the great staples of soft india-rubber, and wishing to complete the account of the business, we stepped (yesterday) into the warehouse of the American Hard Rubber Company, No.

63 Maiden-lane, this city. If the soft rubber manufacture surprises us by the great quantity of its staples, that of the hard rubber does not less astonish us by the endless variety of its products. We were shown, first, a vast assortment of druggists' articles, syringes, caustic-holders, medicine bottles, ear-trumpets, stethoscopes, trusses, tunnels, tumblers, tooth-picks, &c.; secondly, saddlery and hardware goods, martingale-rings, whip-sockets, &c.; and, finally, a great variety of stationers' goods and fancy articles, such as pens, pen-holders, pencils, paper-folders, paper-weights, rulers, wafer-boxes, sand-boxes, finger-rings, watch-chains, brooches, bracelets, necklaces, shirt-studs, ear-rings, tidy-needles, crochet-needles, tatting-needles, crosses, table-casters, thimbles, thread and needle-cases, dice-cups, photographic apparatus, salad-forks and spoons, canes, combs, hair-pins, bonnet-pins, tape-measures, napkin-rings, knife-handles, door-mats, curry-combs, rules and scales for draughtsmen and surveyors, and numerous other articles.

The properties of the hard rubber seem to adapt it to a larger variety of uses than, perhaps, any other substance. It is not perceptibly affected by most of the acids, oils and alkalies; it absorbs no moisture, and is consequently very durable in the atmosphere, and does not shrink and expand by being wet and dried. When used for setting teeth, it does not absorb the moisture of the mouth, and consequently remains inodorous. Efforts have been made to use it for shuttles, billiard-balls, and various other new purposes; and, though the difficulties have not yet been overcome, they will probably yield to the ingenuity of our inventors.

Hard india-rubber is made by mixing one pound of sulphur with two pounds of india-rubber. The patent was granted to Nelson Goodyear (brother of the famous Charles Goodyear), on May 6, 1851.

DEFLECTION OF GIRDERS UNDER DIFFERENT SPEEDS.

Some time ago a statement was made in the London *Athenaeum* that a bridge &c. was not so much affected with a load passing over at a high as a low speed. To this assertion, a correspondent makes the following reply:—

"I have waited to see whether any one would point out the fallacy of Stephenson's statement that 'either iron or ice will bear a weight passing over it at a greater velocity, which it could not bear if it went slower;' and that 'when it goes quick the weight in a manner ceases.' The very reverse of this is the truth, as was clearly established by the Iron Commission, which was appointed a few years since, to inquire into the causes of the breaking down of the iron bridge over the Dee. And the principle so established is now universally acted upon throughout our railroads: the speed of trains, upon approaching bridges of any considerable length, whether of iron or wood, is usually slackened to eight, six, or even four miles an hour, according to circumstances; and the same rule, viz., of going slow, and not quick, is always observed in passing over an unsound part of an embankment. I myself was present at some very interesting experiments made by this commission at the iron bridge of the South-eastern Railroad, near Epsom, in the presence of Lord Wrottesley, Sir W. Cubitt, the Astronomer Royal, and several others. Professor Willis had contrived a very ingenious apparatus, which, fixed to the center of one of the iron girders, measured and registered the deflection of the bridge at the passing over of any weight. An engine with a heavily-loaded tender was then passed over the bridge at speeds varying from 10 to 60 miles an hour, and it was found that the greater the speed the greater the deflection of the girder."

THE AURORA ELECTRIC BATTERIES.—During the prevalence of the brilliant Aurora which lately visited this region, the best evidence of its electrical character was afforded to our telegraphic operators. The atmospheric electricity became so powerful that it overcame the battery current, which in some instances was shut off, and messages were actually sent between Philadelphia and this city by the Aurora. In this case the atmospheric current was no doubt positive, and this affords some proof that the design for storing it up and employing it for useful purposes by balloons, as described on page 9, this volume, SCIENTIFIC AMERICAN, was not so hypothetical as some persons have supposed.

STEAM BOILER EXPLOSIONS.

We feel that this is a hackneyed subject, and approach it with reluctance, but so many explosions have recently occurred, that the public mind is excited to more than the usual degree of tension regarding them. We have now before us nine letters from correspondents on the subject, and these cover 33 pages of manuscript. Some of them are well written and we would willingly publish those if our space permitted, but being unable to do so, we shall endeavor to present the subject-matter of some of them.

One letter from a distinguished practical engineer in Cincinnati contains a description of the explosion which took place in Whittaker's factory, in that city, on the 10th of January last. This explosion cannot be accounted for by common causes, such as excessive pressure, or want of water. The boiler was 20½ feet in length, 38½ inches in diameter, and had two round flues, 16 inches in diameter, of ¼-inch iron. About three weeks before the explosion, the engine and boiler had been put in good repair, and worked three days with the steam at a pressure of 98 lbs. on the square inch. The next time it was used was when the explosion occurred. When steam was raised to 15 lbs. pressure the water was up to the highest gage-cock, and the engine started. It was now worked for 45 minutes at intervals of time, during which the furnace doors were open, and the pressure gradually fell to 10 lbs. The doors were now closed to raise the steam a little higher, and in one minute afterwards the explosion took place. No feed water was pumped into the boiler during the working, as there was plenty of water in it. The two flues collapsed, and the boiler itself was projected through the thick walls of the cellar in which it was placed, which were of blue limestone, then it struck the chimney stack which had 12-inch walls, and it cut through three sides of it; then it encountered the dry-house wall, 2½ feet thick, of blue limestone, and it cut its way through it with a clean hole like that of a bullet passing through glass; thence it passed on and demolished three furnaces standing in a line, each 7 feet square, with 12-inch brick walls; and was only arrested by a cross stone wall 2½ feet thick, built up against the earth pavement on the other side of the street. All the persons in the building were more or less injured, but none fatally. When the boiler was examined there was no evidence of a deficiency of water or excessive heat in it at the time of the explosion; a large amount of water escaped from it in the cellar and into the room above at the time. The steam-gage was afterwards tested and found correct. These facts have been obtained from intelligent and reliable persons, who were in charge of the boiler and engine.

We have been somewhat particular in relating this case because it is one of the most extraordinary and destructive explosions that have ever occurred. The boiler had plenty of water in it, the pressure was only 10 lbs on the inch, and it was capable of standing 93 lbs. Here certainly is a fact for the electrical theory of explosions. There is one other way, however, of accounting for the circumstance. Water deprived entirely of its air can be heated considerably above 212° without indicating an excess of pressure, and it is then liable to explode like gunpowder. As no feed water was pumped into the boiler while it was in operation, all the air was no doubt expelled from it, and the explosion may have been thus caused. This is one kind of explosions.

In a letter from A. H. Goff, of St. Louis, Mo., on this topic, he attributes explosions to two causes, one by superheating the steam when the engine is stopped, and the other by decomposition of the water. When the engine is stopped and no steam taken from the boiler, the fire gradually creeps up the sides of the plates, causing the steam to become very hot and dry, in which condition it has a great affinity for water. When the engine is started, the water is relieved from some of its pressure, thus causing it to rise upon the heated plates. The superheated steam thus receives its full quantity of water, imparting to it such an overwhelming elasticity that few boilers can withstand it.

This no doubt is a full explanation of the cause of many explosions. The remedy for this, as well as the previous conditions for causing an explosion, is to keep the feed pump in motion during the whole time the engine is standing idle. Donkey-engines for feeding boilers have prevented scores of explosions. An explosion by water becoming low in the boiler is thus explained by

our correspondent. When the plates of the boiler become overheated, they decompose the oxygen, and set the hydrogen free; if no water is pumped in, an explosion cannot take place, but "whenever water is introduced, the hydrogen receives its full quota of oxygen, and a terrible explosion is the consequence."

Water (H. O.) is composed of two gases, oxygen and hydrogen. When these are mixed together in proper quantities and a spark sent through them, they explode with violence, forming the fluid water. Neither hydrogen nor oxygen will explode separately. Red-hot iron decomposes water, by the oxygen uniting with the metal and setting the hydrogen free, and this may take place in a boiler in which the water has been suffered to become low, but the fresh feed water cannot supply the requisite quantity of oxygen to cause an explosion, as it merely contains a small amount of atmospheric air, in which the oxygen only forms one-fifth of the whole.

In a carefully-prepared communication by the experienced engineer, J. G. Whitlock, of St. Luke's Hospital, this city, he attributes explosions to saturated hydrocarbon gas, caused by the water becoming too low. For example, if we take common coal, or wood gas, and saturate it with eight times its volume of air and then ignite it, a violent explosion will take place. If the water used for a boiler contains a great deal of organic matter, called "slush," and if a considerable amount of grease finds its way into it, this gas will be generated when the water becomes low and the plates red-hot. It now only requires a sufficient quantity of oxygen to saturate this gas and cause an explosion. Our correspondent believes that this is furnished from the heated air in the boiler, or some other source, as he has never known of an explosion which was not due to a deficiency of water in the boiler at the time. He is of opinion that the gradual accumulation of pressure in the boiler will not cause an explosion, but a mere rip in the metal. He has frequently seen smoke issue from the gage-cocks and valves of boilers when the water became low, and from his long experience and the many facts on the subject brought under his notice, he is of opinion that unless the water becomes too low in a boiler, an explosion will not take place.

We have evidence to the contrary of this, but no doubt he is right in regard to a majority of explosions taking place from a deficiency of water as the leading cause. The preventive for this is in the exercise of more care on the part of engineers. As various heaters for buildings have exploded, we have also received a very able communication on this subject from Mr. Whitlock, which we will publish at an early date, as the time is at hand when many of these will be put up for winter use.

Another correspondent, L. G. Evans, of Spring Hill, Ala., attributes explosions to the water becoming too low, and the plates highly heated, whereby, when fresh water is fed in, a vast amount of steam is rapidly generated, and the boiler is exploded by the excess of pressure. His remedy for such a result is to make the safety-valve of such a large area that it will carry off the excess of steam without rupturing the metal.

A dreadful accident took place at Roach's foundry, Goerck-street, this city, on the 2nd inst, by which several persons lost their lives. The cause of it was low water in the boiler, whereby the plates became red-hot. The gages were examined just a little before the accident and indicated plenty of water. It has been proved that this was owing to the water priming, whereby the engineer was deceived as to its quantity and height. The metal of the exploded boiler was found burnt and brittle.

We have also received a letter from Mr. Thomas Prosser, C. E., this city, on the subject, but as it enters more into the pressures of steam, and the science of expansion, we reserve it for future publication.

Another correspondent proposes arched boiler-heads to prevent the common kind being blown out and torn away.

The conclusions which we draw from all our correspondence on this subject and from information derived from other sources is, that the chief and common danger of explosions is low water in the boiler, when there is an intense fire in the furnace.

Leaving all the theories of the causes of explosions entirely out of the question, the great agent of safety is the feed pump, and engineers should pay the most unre-

mitting attention to see that it is kept in proper order, and that the requisite supply of water is constantly furnished. Not an explosion related in the whole of our correspondence would have taken place had the requisite feed water been supplied.

THE COTTON CROP.

What is called "the crop year" has just closed, and it has been a somewhat eventful one. The previous year of the panic had passed with a very small consumption, leaving large stocks of goods in the hands of merchants, as well as considerable supplies of raw materials in the hands of manufacturers. Returning ease in the money market has been accompanied by abundance of crops, cheapness of food, low rates of transportation, and every element of a large consumption of goods, promising to absorb the whole of the crop, how extensive soever it might prove to be. This promise was not disappointed up to January, and purchases at home and abroad were very large at improving prices. The intervention of war changed the course of events to some extent, imparting a disposition to curtail business, more particularly in the United States, where the purchases of the spinners underwent a sudden curtailment for a season. As a whole, the disposition of the crop has been as follows:—

	1856.	1857.	1858.	1859.
Crops.....	3,550,000	3,150,000	3,150,000	3,700,000
Exports.....	3,000,000	2,400,000	2,650,000	3,000,000
Consumption.....	550,000	650,000	450,000	700,000

The quantity exported this year has been mostly the same as in 1856, but at higher rates. The official values of that year, as compared with the current values this, have been as follows:—

	Bales.	Export value.
1856.....	3,991,175	\$128,882,251
1859.....	3,000,000	157,000,000
Increase.....		\$21,617,649

This amount goes far towards compensating for the decline in breadstuffs. The quantity and value taken by the spinners in the United States, in the two past years, are nearly as follows:—

	Bales.	Value.
1858.....	450,000	\$20,020,000
1859.....	700,000	38,500,000
Increase.....	250,000	\$18,480,000

This marks a high degree of activity among the manufacturers, and in addition to this large production the quantities imported have been considerably increased as compared with last year. The combined supply, however, imported as well as manufactured, has not, taken with last year, equaled the average of the years 1856 and 1857. The continuance of the war caused a rapid decrease in the purchases of the spinners during May and June, under the impression that a prolongation of hostilities would inevitably cause a decline in the material. The restoration of peace has now given a new aspect to the matter, with the promise of some years of repose, accompanied by good harvests, and an earnest desire on the part of the European governments to promote confidence and thereby develop material well-being. The demand for goods is likely to exceed that of any previous year. At the same time, the promise of the cotton crop to this moment is, as far as can be judged at this early day, in excess of that just now brought to market. It is not impossible that the exports of the coming year may be pushed to 3¼ millions, at a price equal to that of 1857, say average \$65 per bale, which give an export value of \$210,000,000, and impart to the southern section of the country a greater degree of prosperity than ever yet fell to its lot. The character of the northern business will probably change. It is always the case that a rise in the value of the raw material induces a change from coarse to fine numbers, that is to say, to put more labor and less material into the fabric. At the same time, the cheapness of food, which favors the development of city business at the expense of the agricultural sections, causes a demand for the finer qualities of cloth rather than the coarser kinds. The demand for material is once more active since the settlement of the peace questions, and the industry of the manufacturers is daily on the increase.—*United States Economist.*

LUBRICATING SUBSTANCES.—A careful experiment, made on the Michigan Central Railroad, in regard to the comparative value of whale and metallic oils, resulted in showing a great difference in favor of whale oil. Running a single train 103 days, one-half of the journals were lubricated with whale oil, consuming 28½ gallons, costing 60 cents per gallon; the other half with metallic oil, consuming 27 gallons, costing \$1.34 per gallon.—*Railroad Register.*

WEEKLY SUMMARY OF INVENTIONS.

The following inventions are among the most useful improvements patented this week. For the claims to these inventions the reader is referred to the official list on another page.

REDUCTION OF METALLIC SULPHURETS, &c.

Messrs. J. J. A. de Bronac and A. J. M. Deherrypon, of Paris, France, have obtained Letters Patent in this country for an improvement in the reduction of metallic sulphurets and other ores, and particularly sulphureted ores of lead antimony, copper, silver and zinc. Their invention consists in the treatment of such ores with what is known as spongy iron, in the following manner. The ore and the iron sponge are first pulverized separately, then mixed in proper proportions, after which the mixture is compressed into small bricks and then treated either in a reverberatory or vertical furnace. The avidity of the spongy iron for new combinations, especially with sulphur, effects desulphurization by the formation of a sulphuret of iron, from which the metal to be obtained is afterwards separated by fusion or volatilization. It is claimed that this process effects a great saving in the time and expense of obtaining metals from such sulphurated ores as can be modified or reduced by iron.

IMPROVED MODE OF CUTTING BOOTS.

This invention consists in cutting out or otherwise forming a piece of leather or of cloth or other material that cannot be stretched by crimping, to a certain novel shape which by the aid of one gore admits of its being folded without crimping into the required form for the upper of a boot, the whole being so arranged that it can be cut from a piece of leather nearly square so as to save as much material as possible, leaving the boot entirely single with no hard seam across the foot and requiring no additional fixtures in order to give it the proper finish. The inventor is Lewis Duvall, of Big Spring, Kentucky.

BAGASSE FURNACES.

C. A. Desobry, of Plaquemine, La., has invented certain improvements in bagasse furnaces. One of these improvements consists in a novel system of air-ducts, combined with an air chamber for supplying the fire-chamber with the air necessary for combustion and for tempering the heat of the furnace; and another improvement consists in a novel construction of the throat or feeding hopper of a furnace for burning bagasse or other refuse fuel, whereby provision is made for feeding without any material escape of the heat of the furnace.

FOAM COLLECTOR FOR BOILERS.

T. G. Gardner, of Mount Pulaski, Ill., has invented a foam collector for steam-boilers which consists of a plate, or plates attached to the sides and heads of a boiler, and so arranged as to cover the whole, or very nearly the whole of the surface of the water therein, but with an opening for the escape of steam, and with a descent from the said opening toward the ends or sides of the boiler. The foam being carried up by the steam against the lower surface of the plate or plates is collected at the aforesaid opening, and caused to pass through it to the upper surface of the plate or plates to a receptacle formed at the lower part of said surface from whence it may be blown off. This seems to be a good contrivance.

IMPROVED EXCAVATOR.

This invention is an improvement in machinery for removing the earth which washes down from embankments and fills up the drains on either side of the railroad, where the latter passes through deep cuts. It consists in the employment of plows and excavators of a peculiar construction, which are connected to suitable arms extending out from the sides of a car by strong chains, so that as the car progresses, the earth can be taken up and removed to the nearest "fillings." This contrivance is the invention of E. O. Baxter, of Foreston, Ill.

IMPROVED STONE-BREAKING DEVICE.

This invention consists in the employment or use of straight or vertical cylinders, peculiarly ribbed, and used in connection with a hopper, the whole being so arranged that round paving stones or "boulders" may be cracked or broken equally as well as regular pieces of stratified rock. The difficulty hitherto attending the cracking or breaking of round stones or other hard substances by means of cylinders has been owing to the inability of the cylinders to catch or seize them, the stones in consequence of their rotundity being liable to turn and slip from the

"bite" as the cylinders rotate. This difficulty is fully obviated by this invention, which has been patented by Ives Scoville, of Chicago, Ill.

MACHINE FOR SECURING THE JOINTS OF CLOTHES-PINS.

This invention consists in the employment or use of a clamping device, pliers, adjusting fork and shears, arranged to operate in such a way that the wire joints or hinges of jointed clothes-pins may be secured in the pins in a very expeditious manner and equally as well as can be done by hand. The several parts comprising a jointed clothes-pin are all made by machinery and the work is done very rapidly, and at a small cost. In articulating the parts or jaws of the pins, however, considerable time has heretofore been used in securing the joints in the parts, this work having been done manually. This invention is designed to supersede the manual articulation of the parts and execute the work with a rapidity commensurate with the manufacture of the individual parts of the pins. The inventor of this device is A. C. Mason, of Springfield, Vt.

MACHINE FOR TONGUING AND GROOVING.

This invention consists in passing the boards to be tongued and grooved under rollers which serve as feed and pressure rollers, having flanges cast on their outer edges which press the faced edge of the board, as it is being fed to the cutters, up firmly against an annular ring keyed to the roller shaft by helical or other suitable springs, which permit the rollers to be laterally adjusted and to be set to the various thicknesses of boards to be matched; at the same time the rollers have a sufficient play to admit of the variations in the width of the same boards. The credit of this invention is due to H. H. Baker, of New Market, N. J.

IMPROVED WATER-METER.

This is a very ingenious device calculated to measure the water by a series of buckets of known capacity and of a peculiar form, which are so arranged in a hollow rotary chamber that the water, as it enters said buckets, causes the chamber to rotate simply by the action of the gravity of the water in the buckets, and entirely independent from the head or force with which it enters. The hollow rotary chamber is arranged in an air-tight vessel of such construction that the pressure on the water in the buckets regulates itself according to the head of the supply water. The inventor is B. S. Church, of Manhattanville, N. Y. This device was patented last week.

FOREIGN SUMMARY—METALS AND MARKETS.

A new apparatus for producing motion in metals by means of heat has lately been exhibited by Mr. G. Gore, of Birmingham, a gentleman favorably known for his scientific attainments. It consists of a massive circular railway of copper, the rails of which are made red-hot, and balls of German silver placed upon them and so arranged as not to run off. Whenever this is effected the balls roll on the rails, making revolution after revolution on the track as long as the rails remain sufficiently hot. This result is stated by the *Philosophical Magazine* (English) to be a new fact in mechanical science. It is no doubt so with this apparatus, but the principle of motion is the very same as that displayed by water rolling in globules on a heated plate of metal.

The largest balloon ever inflated was recently filled at Wolverhampton with 86,000 cubic feet of gas. It was intended for scientific purposes, under the auspices of the Royal Astronomical Society, and Mr. Green, the veteran aeronaut, was to take charge of the ascent. It was purposed to ascend to the height of four miles and make experiments on the humidity of the atmosphere at different elevations, and also make experiments on the polarization of light. It is a subject of regret that, when the ascent was about to be made, a gale of wind came up and struck the balloon, tearing it in several places; and thus the scientific aerial expedition was defeated for the present.

The labor question in England is still exciting deep attention, on account of the great many strikes which have recently taken place among mechanics. The builders in London are still standing out for the reduction of the hours of labor from ten to nine daily. The chain-makers at Cradley in Stourbridge, to the number of 1,500 recently struck for a rise of wages, and the employers have exhibited a disposition to comply with the terms. The bill before the British

Parliament to establish councils of conciliation between employers and workmen in such cases as disputes about wages, hours of labor, &c., provides for an equal number of employers and operatives sitting in the council upon such cases.

Very large orders for iron of all kinds have recently been received from India. One company has ordered no less than 400 tons of railway-fastenings.

The schools of art established by government, principally for educating the youth in those branches requiring a display of taste and refinement, have been quite successful; and no wonder, because great encouragement is given to the pupils in the way of prizes. Thus, in one school in Liverpool, instruction was given last year in drawing to 1,436 pupils, mostly the children of mechanics. Twenty-six medals were awarded, and 89 other prizes. In Liverpool there is also a School of Navigation, the object of which is to raise the character of the mercantile-marine in a practical, scientific and moral sense.

A new method of steam propulsion has lately been tried on the Bridgewater Canal. It consists of an endless chain running over rollers situated at the bow of the boat, then passing along the bottom of the canal and up over pulleys at the stern, thence forward. Its object is to trail on the bottom of the canal, combining something of the principle of an elliptical wheel in action, so as to prevent the water injuring the banks by the swell. The boat run at the rate of five miles per hour, and the chain run eight miles while the boat was moved six—thus showing a slip of 25 per cent. This system of canal propulsion has been favorably considered, and a wealthy company formed to introduce the invention throughout the country.

In the South Staffordshire and East Worcestershire districts there were 129 iron furnaces in blast and 55 out of blast, last month. The average production of iron by each furnace is 110 tons per week. About three tons of coal, the same amount of ore and 12 cwt. of lime are required to produce one ton of pig-iron. The iron trade in England has not recovered from the panic of 1857 yet, and it may be some years before it will. There are 18 per cent less furnaces in blast to-day than there were in September of the panic year.

PRICES OF FOREIGN METALS, AUGUST 28.

	£ s. d.		£ s. d.
Iron, English Bar and Bolt:—		Iron, Swedish, bars, per ton.....	13 0 0
In London, per ton.....	7 0 0	Russian C N D.....	17 0 0
In Wales.....	6 0 0	Steel, Swedish Keg, nom.....	20 10 0
In Liverpool.....	6 10 0	Do. Rolled.....	19 10 0
Staffordshire Bars.....	8 0 0	Faggot.....	21 19 0
Sheet, single.....	9 10 0	Spelter.....	21 0 0
Double.....	11 0 0	Zinc, in sheets.....	28 10 0
Hoop.....	9 0 0	Copper, Tle.....	107 10 0
Rod, round.....	8 0 0	Tough Cake.....	107 10 0
Nail Rod, square.....	9 0 0	Shipping Iron:—	
Staffordshire Bars.....	8 0 0	per lb.....	— 11½
Sheet, single.....	9 10 0	Sheet.....	— 11½
Double.....	11 0 0	Bottoms.....	— 12
Hoop.....	9 0 0	Old.....	— 10
Rod, round.....	8 0 0	Yellow Metal.....	— 10
Nail Rod, square.....	9 0 0	Lead, British Pig.....	23 15 0
Iron, Rails, in Wales, cash.....	6 5 0	Spanish.....	23 10 0
Do. 6 months.....	6 10 0	Sheet.....	23 10 0
In Staffordshire.....	7 0 0	Tin, English Block, nom.....	188 0 0
Railway Chairs, in Wales.....	4 0 0	Bar.....	139 0 0
In Clyde.....	4 0 0	Refined.....	145 0 0
Pig No. 1, in Clyde.....	2 13 0	Foreign Banca.....	145 0 0
3-5ths No. 1 and 2-5ths No. 3.....	2 13 0	Straits.....	143 0 0
Staffordshire Forge Pig, at the works, L. W., nom.....	3 15 0	Tin Plates, Charcoal, 10, per box.....	1 13 0
Welsh Forge Pig.....	— — —	Do. IX.....	1 19 0
Acadian Pig, Charcoal.....	8 15 0	Coke, 10.....	1 7 6
Scotch Pig, No. 1, in London.....	3 10 0	Do. IX.....	1 13 6
		Canada, Plates, pr tin Quicksilver, per bottle.....	7 0 0

English tin is in good demand, and Banca and Straits somewhat higher than the previous week. Copper has also been in good demand, and the prices maintained. An order for 10,000 Iron targets for rifle practice has lately been given out by the British government.

[The above are prices within three per cent discount, the pound being valued at \$4.85.]

New York Markets.

COAL.—Anthracite, from \$4, \$4.50, \$4.75, to \$5.
 CORDAGE.—Manilla, 2½c. per lb.
 COTTON.—Ordinary Upland, 9½c. per lb.; Texas, 9½c.; Middling, 11½c. to 12½c.; Middling fair from 12½c. to 13½c.
 COPPER.—Lake Superior ingots at 25c. per lb for cash; new sheathing, 26c.; no change, but holders are firm.
 FLOUR.—State, superfine brands, \$4 a \$4.30; State, extra brands, \$4.40 a \$5; Michigan, fancy brands, \$4.10 a \$4.30; Ohio, fancy brands, \$4.40 a \$4.50; Michigan, Indiana, Wisconsin, &c., \$4.40 a \$4.90; Genesee, extra brands, \$5.40 a \$7; Missouri, \$4.30 a \$7; Canada, \$4.60 a \$5.50; Richmond City, \$6 a \$7.
 GLASS.—American Window—First, second, third and fourth qualities, per 50 feet: 6 by 8 to 8 by 10. \$3.50 a \$2.75; 8 by 11 to 10 by 15, \$4 a \$3; 10 by 16 to 12 by 18, \$4.50 a \$3.25; 12 by 19 to 16 by 24, \$5.25 a \$3.50; 16 by 25 to 20 by 30, \$6 a \$4; 20 by 31 to 24 by 36, \$8 a \$4.50; 25 by 36 to 30 by 44, \$9 a \$5. These prices are subject to a large discount—sometimes 50 per cent.
 HEMP.—American undressed, \$140 a \$150; dressed from \$190 a

\$210. Jute, \$95 a \$90. Italian, \$2.75. Russian clean, \$210 a \$215 Manila 6½c. per lb.

INDIA-RUBBER.—Para, fine, 56c. a 60c. per lb.; East India, 37c. a 40c.

INDIGO.—Bengal, \$1 a \$1.50 per lb.; Manilla, good to prime, 55c. a \$1.10; Guatemala, \$1 a \$1.15.

IRON.—Anthracite pig, \$23 a \$24 per ton; Scotch, \$23 to \$23.50; Swedish bar, ordinary sizes, \$85 a \$87.50; English refined, \$53 a \$54.50; English common, \$43 a \$45. Russian sheet, first quality, 11c. a 11½c. per lb.; English, single, double and treble, 3½c. a 3¾c.

LUMBER.—Timber, white pine, per M feet, \$17.50; Timber, yellow pine, \$35 a \$36; Timber, oak, \$18 a \$25; Timber, eastern pine and spruce, \$17.50; White Pine, select, \$25 a \$30; White Pine, box, \$14 a \$18; White Pine, flooring, 1¼ inch, dressed, tongued and grooved, \$24.50 a \$25; Yellow Pine, flooring, 1¼ inch, dressed, tongued and grooved, \$29 a \$21; White Pine, Albany boards, dressed, tongued and grooved, \$30 a \$21; Black Walnut, good, \$45; Cherry, good, \$45; White Wood, cherry plank, \$42; Spruce Flooring, 1¼ inch, dressed, tongued and grooved, each, 22c. a 24c.; Spruce Boards, 15c. a 17c.; Hemlock Boards, 12½c. a 14c.; Hemlock Joist, 3 by 4 inch, 12½c. a 14c.; Shingles, cedar, per M, \$23 a \$35; Shingles, cypress, \$12 a \$26; Staves, W. O. pipe, light, \$55 a \$58; Staves, white oak, pipe, heavy, \$75 a \$80; Staves, white oak, bbl. culls, \$20; Heading, white oak hlds., \$55.

LEAD.—Galena, \$5.75 per 100 lbs.; German and English refined, \$3.70; bar, sheet and pipe, from 6c. to 6½c.

LEATHER.—Oak slaughter, light, 33c. a 35c. per lb.; Oak, heavy, 32c. a 35c.; Oak, crop, 38c. a 40c.; Hemlock, middle, 24c. a 25c.; Hemlock, light, 23c. a 24c.; Hemlock, heavy, 22c. a 23c. Patent enameled, 16c. a 17c. per foot, light. Sheep, morocco finish, \$7.50 a \$8.50 per dozen. Calf-skins, oak, 62c. a 65c.; Hemlock, 60c. a 65c.; Belting, oak, 32c. a 34c.; Hemlock, 28c. a 31c.

NAILS.—Cut at 3c. a 3½c. per lb. American clinch sell in lots, as wanted, at 5c. a 6c.; wrought foreign, 3½c. a 3¾c.; American horse-shoe, 14½c.

OILS.—Linseed, city made, 58c. per gallon; whale, bleached spring, 53c. a 55c.; sperm, crude, \$1.25 a \$1.27; sperm, unbleached spring, \$1.35; lard oil, No. 1 winter, 87c. a 92c.; extra refined rosin, 30c. a 40c.; machinery, 50c. a 100c.; camphene, 45c. a 46c.; coal, refined, from \$1.12 a \$1.50.

RESIN.—Common, \$1.60 per 310 lbs. bbl.: No. 2, &c., \$1.70 a \$3; No. 1, per 280 lbs. bbl., \$3.25 a \$3; white, \$3.25 a \$1.50; pale, \$5.50.

SPELTER plates, 5½c. a 5¾c. per lb. STEEL.—English cast, 14c. a 16c. per lb.; German, 7c. a 10c.; American spring, 5c. a 5½c.; American blister, 4½c. a 5½c.

TALLOW.—American prime, 10½c. to 10¾c. per lb. TIN.—Banca, 32½c. a 33c.; Straits, 31c.; plates, \$7.50 a \$9.75 per box.

TURPENTINE.—Crude, \$3.62½ per 280 lbs.; spirits, turpentine, 45c. per gallon.

ZINC.—Sheets, 7½c. a 8c. per lb.

The foregoing rates indicate the state of the New York markets up to September 7th.

Quite a large number of American candles are exported to Cuba and various parts of South America. A. Hay & Bros., manufacturers, this city, supply a large foreign demand. No less than 44,354 boxes were exported from January 1st to August 31st, 1859. This is a slight decrease on the amount shipped last year in the same period of time.

The amount of goods waiting shipment here, at this season of the year, for Charleston, Savannah and New Orleans, is prodigious. More steamers are required for the southern trade. Carmen will sometimes have to wait 10 hours, in turns, before they can get their loads on board the steamer.

The western trade, thus far, has been poor, owing to the previous indebtedness of western merchants. It is to be hoped they will get out of this position by next Fall, at the farthest. They tied up their ready cash in the United States Land-offices in 1856-'57, during the land speculation mania, and it has not yet found its way back to their coffers.

Our iron interests are looking up a little. The Philadelphia North American, of the 3d inst., says:—"There has been rather more inquiry for pig-metal, and holders, if anything, are firmer in their views. Sales include about 1,200 tons anthracite No. 2, a good make, at \$22.50, and 1,500 do. forge at \$21, all on time; the latter price was refused for another lot of the same kind. Nothing doing in blooms or boiler-iron worthy of notice. Rails and bars are steady in price, with rather more doing, and the prospects of the trade generally are now encouraging."

Railroad shares are improving somewhat. The New York Central appears to lead all others in speculative dealings; the stocks advanced from 76 to 79½ per cent. on the 8th, as the receipts on this road during next Fall are expected to be very large. All the shares of our railroads are slowly advancing, which is a good sign of improvement in all kinds of business, as they are our avenues of commerce.

In the open market money continues abundant. The demand is fair, and readily met at the quotations annexed. On call, there are occasional transactions below 5 per cent, but the range for the most part is from 5½ to 6½ on Stock Securities.

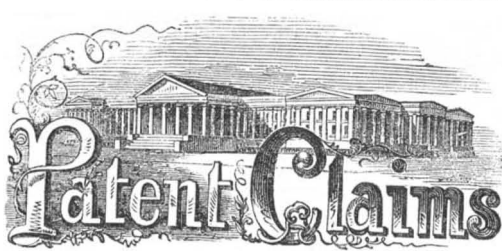

ISSUED FROM THE UNITED STATES PATENT OFFICE FOR THE WEEK ENDING SEPTEMBER 6, 1859. [Reported Officially for the SCIENTIFIC AMERICAN.]

** Pamphlets giving full particulars of the mode of applying for patents, size of model required, and much other information useful to inventors, may be had gratis by addressing MUNN & CO., Publishers of the SCIENTIFIC AMERICAN, New York.

25,310.—H. W. Adams, of Brooklyn, N. Y., for an Improvement in Lamps:

I claim constructing the upper end of the wick tube, B, with the elevated ends, a, a, so as to enclose the ends of the wick, G, and prevent said ends from burning too high, when the central part is sufficiently elevated above the central part, b, of the wick-tube to be allowed to burn, substantially as and for the purpose set forth.

[This invention relates to an improvement in the wick-tubes of lamp tops or burners designed for burning coal-oil and other hydrocarbons of a similar nature. Its object is to obviate the smoking of the lamp heretofore caused by an uneven trimming of the wick, and the tendency or aptitude of the ends of the wick at each side of its top surface to expand or project out more prominently than the central portion during combustion. The invention consists in having the ends of the top of the wick-tube project upward higher than the central part, so that when the central part of the top of the wick is raised sufficiently above the top of the wick-tube to burn, the ends of the top of the wick will be enclosed by the projecting ends of the tube, and combustion confined to the central part, thereby obviating the difficulty alluded to.]

25,311.—Wm. Adamson, of Philadelphia, Pa., for an Improved Apparatus for Making Decoctions. Antedated April 6, 1859:

I claim the conical roller arranged within the caldron, A, when the same is used for the purpose of thoroughly intermixing the ingredients to be extracted during the process of boiling, as set forth.

[This invention consists in placing within the circular tank or boiler a conical roller, either solid or open, and revolving this roller during the process of boiling, for the purpose of thoroughly intermixing the ingredients to be extracted by the water or other fluid, by keeping them in a state of agitation while boiling—such, for instance, as soap, glue, and for extracting coloring matter from dye-woods, &c.]

25,312.—T. D. Aylesworth, of Iliou, N. Y., for an Improvement in the Cutting Apparatus of Harvesters:

I claim a cutting apparatus for harvesting machines, composed substantially of the cutters, c, and guards, b, when constructed and operated together without any motion except that of being advanced or drawn over a field, substantially as described.

25,313.—H. H. Baker, of New Market, N. J., for an Improved Tongueing and Grooving Machine:

I claim the employment of hinged feed rollers, having a lateral pivot, and acted upon by suitable springs, in combination with the fixed intermediate rings, or flanges, P, P, or their equivalents, when arranged and operating essentially in the manner and for the purpose specified.

25,314.—E. O. Baxter, of Foreston, Ill., for an Improvement in Railroad Excavators:

I claim the arrangement and combination of adjustable timbers or arms, B, C, plow and excavator, as above described, when the same are employed in the manner above shown, for the purpose of loosening and removing the earth and keeping the ditch free from the wash of the slopes on railroads.

25,315.—Jehu Brainerd and W. H. Burrigge, of Cleveland, Ohio, for an Improvement in Turning:

We claim the use of the described compound for tanning, consisting of a solution of the named mineral salts, in mixture with a solution of tannin either with or without the addition of aloes:

25,316.—L. R. Breisch, of New York City, for an Improvement in Making Gas from Wood:

I claim the process of manufacturing illuminating gas from wood, by distilling the same in two retorts of varying temperatures, as set forth, one of which retorts is charged with charcoal, varying in amount according to the conditions indicated, the whole process being conducted as set forth.

[This is an improvement on a process for making gas from wood which was invented by Professor Pettenkofer, of Germany, and introduced into this country by Mr. Breisch, in 1853. By this improvement it is claimed that a larger quantity of gas can be made, of a better quality, and with less labor. The inventor has paid much attention to this subject.]

25,317.—Archibald Cameron, of Charleston, S. C., and David Matthew, of Philadelphia, Pa., for an Improvement in Railroad Wheels:

We claim the peculiar construction of car wheels, having elastic curved arms, B, with chilled cast tread, A, and cast hub, C, forming one combined wheel, substantially as set forth.

25,318.—C. W. Clewley, of Providence, R. I., for an Improvement in Machines for Making Watch Rims, &c.

I claim the combination of the male and female plungers, substantially as described and for the purposes set forth.

25,319.—R. W. Davis and Daniel Davis, of Yellow Springs, Ohio, for an Improved Machine for Printing the Addresses on Newspapers, &c.:

We claim, first, The arrangement of wooden blocks, r, of suitable size for a single address, with indented letters in their faces, and attached by means of small tacks, or equivalent to a flexible band or belt, in close compact columns, and operated substantially as described.

Second, The use of the triangular stationary bed-piece, l, over which the belt slides, by means of belt pulley, p, and regulated and adjusted by means of lever, n, substantially in the manner and for the purpose set forth.

25,320.—Jean Justin Albert de Bronac and Augustin Joseph Martial Deherrypon, of Paris, France, for an Improvement in Treating Metallic Ores with Spongy Iron:

We claim the treatment of metallic sulphurets, or other ores, or metallic bodies, with a spongy iron, for purposes substantially as

set forth, by the combination of the several processes specified in the order stated, viz.:

First, Pulverizing the ore and the spongy iron separately.
Second, Mixing the two powders in definite proportions.
Third, Compressing the mixed powders into the form of cakes or small bricks.
Fourth, Treating the thus prepared ores in suitable furnaces, as described.

25,321.—R. Densmore, of South Haven, Mich., for an Improved Machine for Sawing Staves:

I claim, first, Surrounding the stationary drum, B, with a series of saws all hung in one gate and having the same movement, in combination with the rotating table, c, for the purposes and in the manner represented and specified.

Second, I claim, in combination with the rotary table and drum, B, the sliding carriages, when the same are arranged radially around said drum, and operated automatically to feed the bolts up against the drum, B, for the purposes and in the manner specified.

Third, I claim the rolling spring guides, P, in combination with the drum, B, for discharging the staves from the machine after they have been sawed, as set forth.

[The subject of this claim consists in hanging a gang of saws upon circular gates having a vertical reciprocating motion around a drum against which abuts the bolts from which the staves are to be sawed, and in the drum is encircled by a rotary table on which are arranged radially a number of automatic carriages for holding the bolts against the drum, and for feeding the same up to the drum as fast as the staves are sawed, said table revolves around the drum, and feeds the staves up to the saws by means of ratchets and pawls operated by cams fixed upon the saw shaft. It consists also in the arrangement of rolling guides in front and back of the saws around the drum: these are operated by springs situated within said drum, so as to hold the stave after it is sawed until it falls through a conductor.]

25,322.—Charles A. Desobry, of Plaquemine, La., for an Improvement in Bagasse Furnaces:

I claim the combination of the upright air-chamber, D, having a vertical partition wall, a, and the system of ducts, E, E, F, G and H, and the damper or shutter, I, the whole applied in connection with the fire-chamber and the flue, C, or its equivalent, substantially as herein described.

25,323.—Hugh T. Douglas, of Zanesville, Ohio, and John Cooper, of Mount Vernon, Ohio, for an Improvement in Portable Evaporating Apparatus:

We claim the combination of the diving flue, H, I, the valves, F, F', and i, and the damper, J, when the several parts are arranged in relation to the evaporating pan, and operating in the manner substantially as set forth.

25,324.—M. D. Dubois, of Newburgh, N. Y., for an Improved Roofing Cement:

I claim a composition formed of the ingredients or substances compounded in the proportions and in the manner as herein specified, for the purpose set forth.

[The object of this invention is to obtain a roofing cement that will not soften under the rays of the sun, at least not in an appreciable degree, and at the same time one that will not harden and crack at a low temperature.]

25,325.—Lewis Duvall, of Big Spring, Ky., for an Improvement in Boots:

I claim the within-described method of cutting the piece of leather or other suitable material, A, and uniting the same with the gore, B, so that when it is folded in the lines b b', and f f', and if the gore is brought in the proper position, said piece, A, together with the gore, assumes the required shape of the upper of a boot, substantially as specified.

25,326.—William T. Edson, of Philadelphia, Pa., for an Improved Machine for Cutting and Finishing Shoe-heels:

I claim the combination of the movable post, F, the former, H (on the upper of the shoe) the guide, K, and the cutter wheel, D, or an emery or burnishing wheel, with the hand lever, G, bow guide, O, springs, N N, and radius bar, J, acting substantially as set forth, for cutting or shaping, smoothing and burnishing the heels of shoes, either before or after they are fastened to the shoe.

25,327.—Benjamin G. Fitzhugh, and McClintock Young, Jr., of Frederick, Md., for an Improvement in Automatic Rakes for Reaping Machines:

We claim the locating of an automatic sweep rake at the rear left hand or outside corner of the platform, when said rake has a rising and falling motion that will admit of its passing over the outside division board or fence, and then drop into or on to the extreme outer end of the platform, and sweep it of the cut grain, substantially as described.

25,328.—Thomas G. Gardner, of Mount Pulaski, Ill., for an Improved Foam-collector for Steam Boilers:

I claim fitting a boiler with one or more plates, so applied as to present inclined surfaces above the surface of the water, with one or more outlets, b b, for steam and foam, at the highest parts of said plate or plates, and as to provide a receptacle for foam above the said plate or plates, substantially as described, and to operate substantially as set forth.

25,329.—Edward Hæckel, (assignor to Hæckel & Co.) of Cincinnati, Ohio, for an Improved Apparatus for Mashing:

I claim the described combination and arrangement of the central shaft, C, and satellite shafts, N, the whole being armed with beaters, Q, and rotated simultaneously, substantially in the manner and for the purpose set forth.

25,330.—E. H. Hancock, of Augusta, Ga., for an Improvement in Flood-gates:

I claim the combination of the flood or dam gate, C, tilting trough, D, and the draining structure, A, B, or its equivalent, substantially as and for the purpose set forth.

25,331.—Jason W. Hardie, of New York City, for an Improvement in Sewing-machines:

I claim, first, The method of making the "knot-stitch," as described, namely, by taking the needle thread at the back of the needle, or at the side opposite to the position of the bobbin, and first doubling it upon itself around the needle and then looping it over the bobbin thread substantially as specified.

Second, I claim the employment of two hooks, h, h, acting in opposite directions, when they take the thread at the back of the needle, or at the side opposite to the position of the bobbin, for the purpose of forming either the knot-stitch or the ordinary shuttle-stitch, by simply reversing the motion of the driving shaft, as set forth.

Third, I claim making the feed eccentric, i, self-adjusting by means of the loose sleeve, u, slot, v, and pin or stop, 14, so that the feeding shall take place during the descent of the needle, whichever way the driving shaft may be turned, as described.

25,332.—Hiram H. Herrick, of East Boston, Mass., for an Improved Carpet-sweeper:

I claim, first, Providing the end of the box with a groove, as from x to x, when the same is used in connection with the flaring brush on the end of the shaft, P, substantially as and for the purpose specified.

Second, Dividing the box into two parts, and providing each with a partition dividing the bottom of the box into two parts, through which the brushes protrude, and providing these parts of said bottom with flanges which hold the dirt; the several parts being connected and arranged together substantially in the manner set forth.

25,333.—Kelsey Hazen, of Brooklyn, N. Y., for an Improved Amalgamator:

I claim compelling the water having the particles of gold in suspension to flow within a certain small distance of the heated mercury, under conditions substantially as set forth.

I also claim, in connection with the above, the employment of a series of vibrating agitators and scrapers, P, acting in the space under B, and of an adjustable gate, G, for regulating the facility of egress of the suspended particles, when combined and arranged substantially as and for the purpose set forth.

25,334.—Iris Hobson, of Stout's Grove, Ill., for an Improvement in Mole-plows:

I claim the combination of a ditching plow-beam, having a horizontal joint forward of the mole and colter, with a rod arranged over the top of said joint, and with a horizontal adjusting and stop-plate, substantially as set forth.

25,335.—Lewis G. Hoffman, of Waterford, N. Y., for an Improved Door-bolt:

I claim the combination of a common door-bolt with a barrel containing a wheel, with an arm acting on a slot in the bolt, so that when operated by a key the door may be fastened or unfastened on the outside; the whole being so constructed and arranged as not to interfere with the ordinary mode of using the bolt on the inside.

25,336.—Lorenzo Holtslander, of Oberlin, Ohio, for an Improvement in Marine Propellers:

I claim the device described for changing valve-seats, as applied to water propellers, to reverse the motion of vessels or boats.

And also the combination of the small forward pipes, p p p s, with the reservoir, R v, substantially as described.

25,337.—George Hutchison, of Allegheny, Pa., for an Apparatus for Printing the Address on Newspapers, &c.:

I claim, first, The inclined hopper, j, with the slides or guides, m and n, in combination with the ways, k, and conveyors, g, on the belt, f, as described and for the purpose set forth.

Second, The use of a metallic belt, furnished with the conveyors, g and h, as described and for the purpose set forth.

Third, The arrangement of the pulleys, d and e, the belt, f, press-roller, p, and inking-roller, 4, as described and represented.

Fourth, The use of the lug, y, on the end of the type frame, when used in connection with the notch, o, in the conveyor, h, as described and for the purpose set forth.

25,338.—Damase Lamoureux, of New York City, for an Improvement in Parlor Grates:

I claim, first, So constructing the grate that the fuel box and the ash pit are distinct from and independent of the bars, and capable of being removed, while the bars remain undisturbed, thereby enabling me to effect the removal of the ashes and cinders with much less trouble than by the ordinary mode, and thereby keep the apartment free from the dust and dirt which are inseparable from the common method of removal as fully described.

Second, The combination of the crank, L, the rod, I, and the movable bottom, E, of the fuel box, constructed and arranged as described, by which an easy and convenient means of giving a reciprocating horizontal circular motion of the grate bottom is secured without the necessity of cutting an opening in front for the passage of an arm, by which to vibrate the grate, substantially as described and for the purpose set forth.

Third, The arrangement, in a parlor grate, of the bottom grate upon which the fuel is supported, in the manner described, by which it is made capable of being vibrated through the back of the fuel box, upon a fixed axis placed entirely back of the space devoted to fuel, the wings of said bottom grate being so extended as to cover or compensate for the necessary vibration which is made into open space back of the fire box as set forth.

25,339.—Pierson Leffel and J. H. Mulholland, of Springfield, Ohio, for an Improved Method of Centering in Watchmaker's Lathes:

We claim, first, A vibrating mandrel, arranged within a socket or hollow spindle in such manner that its inserted end may fit closely within said socket, and its outer end allowed to vibrate, substantially as described for the purposes set forth.

Second, In combination with the vibrating mandrel, D, we claim the rocking collar, f, spring, e, key, k, and nut, j, all constructed and arranged to operate substantially as described for the purposes set forth.

25,340.—Hosea Lindsey, of Ashville, N. C., for an Improved Submerged Pump:

I claim the arrangement of the short reciprocating piston rod, E, open pistons, F F, sliding ring-valves, G G, cylinder, B B, having a conducting pipe, D, with the chain, H, and brake, I, in the manner and for the purpose set forth.

25,341.—George M. Longacre, of New Orleans, La., for an Improvement in Steam Pans for Clarifying Sugar:

I claim, in combination with the pans, the relief valve, V, and the check valve, t, when arranged and operated as, or substantially as, and for the purpose set forth.

25,342.—Justus R. Loomis, of Winsted, Conn., for an Improvement in Lamps:

I claim the arrangement of the cylindrical corrugated skirting, J, perforated tubes, G, adjustable radiating wires, I I', in the manner as and for the purpose described.

25,343.—Edward M. Manigle, of Philadelphia, Pa., for an Improvement in Stoves:

I claim the arrangement of the series of distinct or uncommunicative hollow open air-chambers, f f, or their equivalents, in combination with the cross-piece of the top plate, B, of a cooking stove, substantially in the manner and for the purpose set forth and described; and this I claim whether the said cross-piece, A, be either movable or stationary in the said top plate.

25,344.—Alvin C. Mason, of Springfield, Vt., for an Improved Machine for Wiring the Joints of Clothes Pins:

I claim, first, The intermittingly-rotating pliers, E E, in connection with a clamping device formed of the jaws, I, recess, a, and lever, R, or their equivalents, and shears, L L, arranged to operate substantially as and for the purpose set forth.

Second, In combination with the pliers, E, and shears, L, and clamping device, the sliding forks, g, arranged for joint operation as set forth.

Third, The particular manner of opening and closing the pliers, E, and operating the arbors, D, to wit: by means of the sliding cones, F, in connection with the springs, f, and permanent bosses, g, on the arbors, D, whereby the jaws of the pliers are opened and closed, and the arbors, D, shifted by a very simple mechanism.

25,345.—Thos. J. Mead, of Port Byron, N. Y., for an Improvement in Brakes for Railroad Cars:

I claim the combined use of the U-shaped yoke, the brake bars and the short brake-blocks, for the purpose of adapting the brake to a simple lever that acts directly upon it as stated.

25,346.—Wm. Mosher and Isaac H. Mosher, of Greene, N. Y., for an Improved Machine for Bending Wagon-tire:

We claim the clutch or clasp to hold the end of the bar, in combination with the former being made three-fourths of the circle, and the arrangement of the lever for operating as specified and for the purposes set forth.

25,347.—Jacob Parker, of St. Louis, Mo., for an Improvement in Trunks:

I claim, first, Forming the lid of the trunk in the shape of a semi-cylinder as specified, for the purposes set forth.

Second, The impervious box, g, or sponge-carrier, arranged in the tray as described.

Third, The peculiar formation of the division boards, n n, in such manner that they will come down on the rim of a gentleman's hat, placed in the middle hat box, as specified.

25,348.—Henry Pennie, of Buffalo, N. Y., for an Improvement in Bits for Cutting Washers:

I claim, first, The arrangement of the cutters, D and D, upon the ends of the sliding bars, C and C, and at right angles thereto; the said sliding bars passing through a mortise in the shank, A, and lying parallel with each other, and one above the other, so that the cutters will work upon the same side of the center-point, B, substantially as described.

Second, I claim the recess, g, made in the lower end of the shank, A, so as to allow the inner cutter to slide close up to the point, B, and thereby adapt the instrument to cutting very small washers, as set forth.

25,349.—James Powell, of Cincinnati, Ohio, for an Improved Faucet:

I claim the elastic annular valve-seat, S, and sliding collar, O, in the described combination, with an adjustable plug valve, L, of hard metal.

25,350.—Isaac C. Shuler, of Amsterdam, N. Y., for an Improvement in the Construction of Sheet-metal Coffins:

I claim, first, The construction of a sheet-metal coffin in two sections, stiffened with frames or straps; and, in dividing the coffin into two sections, I do not confine myself to any particular locality on the sides for making the joints, but claim forming the joint on the side of the wall at any convenient point between the flange, o, and the rim, b, and concealing the same with an adjustable molding.

Second, I claim the frames, c d e f g h and i, for stiffening the coffin, substantially as described; and also the scrolled rim or joint, b, substantially as described.

25,351.—David G. Stafford, of Syracuse, N. Y., for an Improvement in Stoves:

I claim the combination of a self-regulating valve applied to the smoke-pipe of coal stoves, and operating substantially as set forth, with an air-flue surrounding the fire-box, constructed as described, the whole arranged substantially as stated.

25,352.—Joseph Tiben, of St. Louis, Mo., for an Improvement on Grates:

I claim arranging the adjustable furnace back, B, in the furnace place, and constructing and operating the same substantially as set forth.

25,353.—William S. Todd, of Mechanicsville, Iowa, for an Improved Joiner's Clamp:

I claim the combination of the adjustable lever, F, with the frame, A, and sliding block, C, when the same are arranged and operate in the manner and for the purposes set forth.

[This invention consists in arranging upon a slotted frame a sliding head-block, provided with rack teeth, and in operating this head-block by means of a pawl and lever. The latter is made adjustable on the frame so that greater purchase can be maintained in clamping very wide or very narrow boards.]

25,354.—Louis Tregre of the Parish of St. John the Baptist, La., for an Improvement in the Construction of Cane Juice Boxes:

I claim the method of separating the pure from the impure parts of the juice when the latter has settled to the bottom of the box, so that the pure parts can be drawn off without disturbing the impure, by dividing the one from the other by means of a movable partition valve, or its equivalent, arranged within the box substantially as described.

25,355.—E. A. Tuttle, of Brooklyn, N. Y., for an Improved Hot-air Register:

I claim the arrangement and combination with the leaves, C, of the roller, E, having its axis movable and traveling on a shelf, G, with or without springs, b, as and for the purpose shown and described.

[This invention consists in operating the leaves of the register by a smooth or serrated tread roller, which acts upon a shelf upon which the roller is supported so as to entirely or partially open or close the leaves; said roller having a free horizontal motion to travel back and forth upon said shelf in opening or closing the register. Springs are also arranged in such relation to the roller, that they prevent it from being self-acting at the same time they keep the roller firmly down upon the shelf.]

25,356.—Stephen D. Tucker (assignor to R. M. Hoe, R. Hoe and P. S. Hoe), of New York City, for an Improved Mode of Operating the Fingers of Printing-presses:

I claim operating the finger-shaft, C, by means of a grooved disk, E, attached thereto, and the roller, j, attached to a plate or proper support, so as to be respectively within and without the path of rotation of the finger-shaft, substantially as and for the purpose set forth.

25,357.—Lemuel T. Wells, of Cincinnati, Ohio, for an Improvement in Printing-presses:

In the described combination with stationary buttments, C, on the ways, I claim the attachment to the bed of a closed cylinder, D, its piston, E, F, having a stroke relatively less than that of the bed, and acting to simultaneously condense and purify the air at alternately opposite ends of the cylinder, as set forth.

25,358.—S. H. Wilder, of Grinnell, Iowa, for an Improved Method of Opening Valves to Extinguish Fire:

I claim the arrangement, essentially as described, of a reservoir or other means of producing pressure, combined with a system of tubes, cross tubes and valve shafts with valves and stop-cocks, arranged as described, when used as a means of operating upon a cylinder and piston, or a water-wheel, for the purpose of starting and afterwards stopping the wheel or engine without the intervention of any person than the one who discovers the fire.

I also claim the use of gear-wheel, i, rack bar, h, and blank wheel, H, or their equivalents, arranged to move the gate of a water-wheel out and in alternately by a repetition of the same motion.

25,359.—William C. Allison (assignor to himself and John Murphy), of Philadelphia, Pa., for an Improved Apparatus for Watering and Sweeping Railways:

I claim, first, The horizontal perforated pipe, T and T', and the swing pipes, W, in combination with a truck having wheels adapted to the rails of a passenger railway, the said truck carrying a tank, L, and the said swing pipes being arranged and operated by the devices described, or their equivalents, substantially in the manner and for the purpose set forth.

Secondly, The combination of the adjustable revolving brushes, 19, with the truck, when the brushes are arranged in respect to the rails, substantially as and for the purpose specified.

Thirdly, I claim, in combination with the brushes, any convenient number of projections, 20, revolving simultaneously with the said brushes, and so arranged in respect to the rails as to clean the grooves or corners of the treads from all obstructions.

25,360.—William Barnes (assignor to Philo B. Stewart), of Troy, N. Y., for an Improved Feed-water Apparatus for Steam Boilers:

I claim, first, In combination with a steam boiler, A, and a close

chamber, B, placed higher than or at the same height as the boiler, and having communication therewith by a steam passage, e, and a water passage, f, each provided with a stop-cock or valve, substantially as described, a close receiver, C, located lower than the boiler, and having a steam passage from the boiler and a water passage into the chamber, B, substantially as set forth, for use in raising water from a place lower than, and introducing it into the boiler while the boiler is charged with steam.

Second, And I also claim, in combination with the matter above claimed, making the receiver, O, in two parts, Y and X, with the steam pipe, C, from the boiler, A, and the cold water supply pipe, b, both entering one part, and the hot water supply pipe, a, entering, and a water pipe, d, to the chamber, B, leaving the other part, and with the two parts of the receiver connected together by a passage, h, substantially as and for the purpose set forth.

25,361.—Delectus Durefy, of Fort Seneca, Ohio, assignor to himself, L. A. Lyon and H. P. Tyler, of Clarksfield, Ohio, for an Improvement in the Mode of Applying Power to Machinery:

I claim the combination of the treadle levers, g, arms, g², and springs, c, with the grooved wheel, B, and spring braces, k, operating as described and for the purposes set forth.

25,362.—N. A. Dyar, of Medford, and J. F. Augustus, of Boston, Mass., assignors to Joseph C. Tucker, of Brookline, N. H., for an Improved Compound Illuminating Fluid:

We claim the combination of ingredients for the purpose set forth, and essentially in the proportions described.

25,363.—George Henderson (assignor to himself and George Hutchison), of Allegheny, Pa., for an Improvement in Printing-presses for Addressing Newspapers, &c.:

I claim, first, The combination and arrangement of the guide table, g, and pulley, h, the press wheel, d, the conveying pulley, e, and inking rollers, k, with type frame, j, and the open hopper, the whole being combined, arranged and constructed in the manner and for the purpose specified.

Second, The use of the open hopper, when constructed as described and used for the purpose set forth.

Third, The use of the pins, o, or their equivalent, on the type frame, j, for the purpose of carrying forward the papers, as set forth.

25,364.—Chas. E. Jacot (assignor to Saltzman, Jacot & Co.), of New York City, for an Improvement in Watches:

I claim, first, Constructing the bridge or plate, c, with the curve, i, and index, s, for the purposes and as specified.

Second, I claim constructing the bridge-plate, c, separately from, but screwed to the three-quarter plate, b, for giving access to the center, second and third wheels, without removing said three-quarter plate, as described and shown.

Third, I claim attaching the three-quarter plate, b, to the dial plate, a, by riveting the columns, 1, to the plate, b, and inserting the screws, 2, at the dial plate, a, for the purposes and as set forth.

Fourth, I claim constructing the click spring, e, as specified, for preventing the ratchet teeth being broken, as specified.

25,365.—John Martino (assignor to D. Stuart and Richard Peterson), of Philadelphia, Pa., for an Improvement in Stoves:

I claim the division plate, L, with its damper, N, the plate, k, with its openings, and the casing, J, with its wings, t, t, where the several parts are arranged in respect to each other and to the outer casing and fire-pot, as and for the purpose set forth.

24,366.—Robert Poole (assignor to himself and German H. Hunt), of Baltimore, Md., for an Improved Forcing Pump:

I claim enlarging the areas of the inlet and exit openings, where they connect with the pump cylinders, by means of the swells, O P, substantially in the manner and for the purpose set forth.

25,367.—Robert Poole (assignor to himself and German H. Hunt), of Baltimore, Md., for an Improvement in Pistons of Pumps:

I claim a valve made of flexible material, hung loosely upon the piston rod, and having for its bearings the round edged wings of the nut by which it is fastened to the piston, substantially in the manner and for the purposes described.

I also claim, in combination with a flexible valve and winged screw-nut, a piston constructed of ribs, which presents sharp edges to the water while they are flat at the end, which constitutes the seat of the flexible valve, substantially in the manner and for the purpose described.

25,368.—John B. Powell (assignor to himself and G. B. Frick), of Philadelphia, Pa., for an Improved Automatic Fan:

I claim the spindle, M, with any convenient number of cog-wheels of different sizes, in combination with a similar number of cog-wheels, also of different sizes, on the crank spindle, S, when the said spindle and its wheels are rendered adjustable, and are applied to and combined with the work of the automatic fan, substantially as and for the purpose set forth.

25,369.—Charles H. Raymond (assignor to the Peck-smith Manufacturing Company), of Southington, Conn., for an Improvement in Tin-folding Machines:

I claim the arrangement of the clamp, E and G, with bed-piece, D, and folder, N, when combined with revolving gage, B, so that the width of the crimp or fold may be first gaged, and then that portion of the tin contiguous to the part intended to be folded be first firmly clamped and held fast, and then the fold or crimp formed thereon in the manner described, all by one simple movement of folder, N, and parts in connection, and without marring the tin, all in the manner fully set forth.

25,370.—G. W. Richardson and Robert Glover (assignors to themselves, J. B. Williams and W. A. Horrell), of Grayville, Ill., for an Improvement in Harvesting Machines:

We claim the cams, a, cast in sections of one or more, and secured to the driving wheel by means of a bolt or screw, C, and flange, b, in the manner described for the purpose specified.

25,371.—Ives Scoville (assignor to himself and W. H. Scoville), of Chicago, Ill., for an Improvement in Machines for Breaking Stones for Turnpike Roads, &c.:

I claim the arrangement, in the manner set forth, of the funnel-shaped hopper, C, constructed substantially as described, with the two vertical cylinders, A, A, constructed substantially as described, for the purpose of breaking stones for ballasting railroads and macadamizing streets, turnpikes, &c.

25,372.—Daniel H. Solliday, of Philadelphia, Pa., assignor to Edward H. Ashcroft, of Boston, Mass., for an Improvement in Gas-burners:

I claim the application of the conical or chambered burner, A, to the main burner, B, in manner and for the purpose substantially as set forth.

25,373.—Silas B. Terry (assignor to Silas B. Terry, Jr.), of Terrysville, Conn., for Machine for Making Paper-boxes:

I claim, first, The pressure roller, L, in connection with the rotating

clamp formed of the head, D, and disk, f, arranged substantially as and for the purpose set forth.

Second, In combination with the pressure roller, L, head, D, and disk, f the ring or band, B, provided with the pins or strips, I, the socket, F, provided with the screws or pins, j, and the guide plate, G, arranged for joint operation as and for the purpose described.

Third, The arrangement of the pressure lever, H, and sliding mandrels, B C, for the purpose specified.

Fourth, The employment or use of the folding device formed of the plate, N, provided with the ledge, u, and the pivoted bar, v, when said folding device is used in connection with the pressure roller, L, rotating head, D, and disk, f, for the purpose set forth.

[This invention relates to a machine that is designed to facilitate the manufacture of paper boxes, and consists in the employment or use of a rotating clamp, gage or socket, discharging ring, pressure roller and guide: the parts being so arranged and used in connection with a folding device, that the manufacture of the above-named boxes is greatly expedited and the work done in a perfect manner.]

25,374.—Joseph Wesley (assignor to Joseph B. Wesley), of Providence, R. I., for an Improvement in Skeleton Skirts:

I claim a new article of manufacture, to wit, a skirt having its hoops supported by tapes or straps, which are rendered adhesive by the application of caoutchouc or gutta-percha, in the manner and for the purpose substantially as described.

[This invention consists in a skirt having its hoops secured to their suspending straps, at their several points of intersection, by the application of india-rubber, gutta-percha, or their equivalents, in an adhesive condition between the hoops and two plies of which the straps, or those parts of them which cross the tapes, are composed. The skirt thus made constitutes a new article of manufacture, and is more durable than any other kind.]

RE-ISSUES.

William S. Lavelly and James M. Cooper (assignees of Josiah Ells), of Pittsburgh, Pa., for an Improvement in Revolving Fire-arms. Patented Aug. 1, 1854:

We claim, first, The use of a stud in the trigger vibrating laterally in combination with a bevel-edged hammer, for the purpose of raising the hammer to full cock and firing the piece by simply pulling the trigger, which, after the discharge of the piece, will regain its position for repeated action, or (as a mere modification of arrangement) the use of a stud in the hammer vibrating laterally, in combination with a bevel-edged trigger, for the purpose specified.

Second, The use of a bevel-edged hammer, with or without a notch in its toe, and trigger with vibrating stud and cam for the trigger spring, constructed and arranged substantially as described, for the purpose of causing the hammer, trigger and revolving breech to assume their proper relative positions at full cock by simply pulling the trigger, and retaining them in that position and securing the breech from rotation or displacement preparatory to firing.

Third, The notch or depression in the toe of the hammer at the point of contact of the stud and edge of the hammer, in combination with the laterally vibrating stud, for the purpose of preventing the slipping of the stud and the more easy retention of the hammer at the point of full cock.

Fourth, The mode hereinbefore described of locking the rotating breech at the moment of firing by means of the locking bolt operated by the trigger, in combination with the hexagonal neck of the rotating breech, which nevertheless permits the breech to be freely rotated by hand or otherwise when the trigger is not drawn back.

Fifth, The use of a double trigger spring or spring and lever, for the purpose set forth.

Henry Jenkins, of Cincinnati, Ohio, for an Improved Ornamental Connection of the Parts of an Iron Fence. Patented Jan. 30, 1852:

I claim forming the ornament or cast-iron connections for a railing, fence or other article of iron, cast into a divided iron mold, substantially as and for the purpose specified.

Jacob H. Mumma, of Harrisburgh, Pa., for an Improvement in Straw-cutters. Patented Jan. 26, 1858:

I claim, first, The combined application to straw-cutting machines of a changeable feed gear, with two-edged revolving cutters or blades, when so made as that, by changing them end for end on their arms or supports, they shall bring a different cutting edge into action, or when run in either direction, shall always feed in the material in one and the same direction, substantially as and for the purpose stated.

I also claim the combination of feed rollers acted upon by tappets and the crushing rollers controlled by gum elastic springs, when arranged in relation to, and acting in connection with the cutting apparatus, as described and represented.

John W. Marsh, of Oxford, Mass., for an Improvement in Sewing Machines. Patented Oct. 27, 1857:

I claim, first, The combination of the slide, A, provided with its guard, E, and its slot or slots, C D, with the foot-piece, M, with its guide, N, and slots, arranged and operating substantially as described.

Second, I claim the combination with the sewing apparatus, or its equivalent, of a movable knife operated by a connection with the sewing machine, so as to trim or cut the work whilst being sewed, substantially in the manner and for the purposes as set forth and described.

DESIGNS.

Philo B. Gilbert, of New York City, for a Design for the Handles of Spoons and Forks.

Elmira J. Ney, of Lowell, Mass., assignor to the Lowell Manufacturing Company, for a Design for a Carpet Pattern.

History of the Scientific American and Important Information to Patentees.

We have printed a supplementary edition of the SCIENTIFIC AMERICAN, in which there is a history of its rise and progress, with illustrations of the building, externally and internally, showing the spacious rooms in which our immense patent business is conducted, and with life-like representations of the artists, engineers and specification writers at their daily labors. The same paper contains information on the many intricate points arising in patent law and practice, and comprises the best popular treatise on the subject ever published; it should be in the hands of all who are interested either in procuring, managing or using patented inventions. The legal information contained in this paper is the result of FOURTEEN YEARS' experience as patent solicitors, and it cannot be found in any other treatise on patent law. It also contains information in regard to Foreign Patents and Extensions. It is published in octavo form, sixteen pages, and mailed upon receipt of two three-cent stamps. Address MUNN & Co., publishers of the SCIENTIFIC AMERICAN, New York City.

Back numbers of the SCIENTIFIC AMERICAN, to the commencement of the New Series (July 2), are in all cases sent to new subscribers, unless the person ordering them directs to the contrary. Our object in so doing is that subscribers may have the volume complete, which nearly all desire.

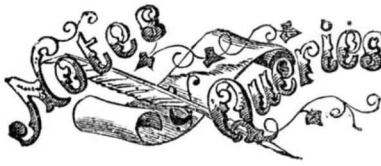

A. K. E., of Mass.—By an Act of Congress the whole matter of copyright for books, pamphlets, works of art, labels, &c. has been placed under the supervision of the Commissioner of Patents. His construction of the law is likely to interfere with the vendors of patent medicines and some other tradesmen who have been in the habit of copyrighting labels for their bottles and boxes. The Commissioner decides that when a production is issued as a work of art, and is intended for sale as such, it may be copyrighted; but that when not produced for sale as a work of art, but evidently for a label, it falls under the patent laws. A copyright costs fifty cents, and gives a monopoly for twenty years, whilst a patent costs \$15, and gives a monopoly for but seven years; on applications for patents for such designs, drawings and a specification are necessary. We are prepared to undertake your case, and to prepare all the papers whenever you are ready to proceed.

D. M., of Ill.—Your rotary engine is an entirely impracticable thing. You may get a rotary motion of the wheel by the mere impact of a jet of steam acting on the concave surfaces of the buckets, but without an abutment for the pressure of the steam to act against you will get no available power. With the addition of such an abutment you will have one of the oldest forms of rotary engines which, with various modes of applying the abutment, is described in the earlier numbers of Vol. IV of the SCIENTIFIC AMERICAN, under the caption of "History of the Rotary Steam-engine."

L. I., of Ind.—The mathematical problem you present for our solution is by no means a difficult one. The area is equal to 587.940 square feet, or 13 acres and 56 square rods.

R. M., of —If you have invented any new process, you are entitled to a patent for it. Until your plan is clearly described to us, we cannot pronounce an opinion regarding it.

J. J., of Conn.—The parties who build, or use, or sell a patented machine are liable to prosecution. They may be prosecuted either separately or collectively.

M. G., of Md.—All the wine exported to this country contains some spirit for the purpose of preserving it; brandy is generally used for this object. This spirit is also frequently added to blackberry wine, but it is not absolutely necessary if the wine is bottled, sealed, and kept in a cool cellar.

C. C. S., of Vt.—Cast-iron water-pipes will not last so long as those of lead; and small wrought-iron pipes endure but a very short time. The tincture of iodine diluted with one-half its bulk of water, is a superior liquid for browned gun barrels.

J. W. H., of Iowa.—Blanchard's patent for turning irregular forms will not expire until January 20, 1862.

J. H. C., of Ga.—You will find knitting-machines advertised in our columns. A planing-machine can be purchased of S. C. Hills, 12 Platt-street.

S. H., of Maine.—Why a cold stove, which had been in use two years, should break across the top, and in 15 minutes crack the second time, belongs to a very mysterious department of nature, the molecular change in solid substances. The wrought-iron axles of railroad-cars have sometimes been found, after long use, to present a decidedly crystalline structure. Barley sugar is at first amorphous, but gradually crystallizes while retaining the solid state. But why this change takes place nobody knows.

F. H. A., of Mass.—There is no rain in the upper portions of the atmosphere. If, even in the tropics, we ascend only three miles into the air, the rays of the sun seem to have lost their power, and we shiver with the cold. If the moisture is here condensed at all, it is in the form of hail or snow, which melts into rain only after it has fallen into the lower and warmer air. Warm air will hold more moisture than cold air; and when warm air that has become saturated with moisture is cooled, a portion of the water is squeezed out of it, and falls, in the form of snow, hail or rain.

C. F. S., of N. C.—Charcoal dust mixed with night-soil will render it inodorous, without injuring it as a manure. Quick-lime or sulphuric acid will also destroy the smell with some damage to the manure. We have just received a recent French periodical which contains a detailed description of a new process for rendering night-soil inodorous, and preparing it for transportation; but the account is too long for our columns. The substances used are charcoal, sulphuric acid, muriatic acid, and salt.

F. J. J., of Conn.—Tidal wheels are nearly like the undershot kind. They are constructed in a similar manner, and have straight radial buckets. They answer very well for some situations but can only be used during certain hours each day. In several places on Long Island these wheels are still used on the salt creeks; there is a very aged one (which is sometimes employed for grinding plaster) on Newtown Creek, in Williamsburgh, N. Y.

A. W., of Maine.—We cannot refer you to any person in London connected with the painting of dissolving-views on exhibition at the Polytechnic Institution of that city.

H. W., of N. H.—You will find a full description of Hill's Air Light on page 109, Vol. XIV, SCIENTIFIC AMERICAN. It will be well for you and others desiring information on this subject, to read the article referred to with attention.

H. C., of N. J.—A little oil of cloves poured into a bottle containing gum mucilage prevents the latter from becoming sour and putrid; this essential oil possesses great antiseptic powers.

G. B., of N. Y.—We do not understand the principle of vegetable life, nor do we know any person who does. This is one of those secrets of nature which she has not yet revealed to man, and one which, we believe, he never can comprehend.

J. A., of Ill.—It would take up too much of our space to describe the construction of the engines of the frigate "General Admiral." In Vol. XIV, SCIENTIFIC AMERICAN, you will find a partial account of their dimensions. There have been some works on propellers published in London.

M. G. F., of N. Y.—The black enamel to which you refer on iron mantel-pieces is composed of a paste of protoxyd of iron and cobalt put on the metal and fused in a proper oven. Common blackmantel-pieces are colored with asphalt varnish. Several coats are put on as a base, and when dry are rubbed down, and a finishing coat of copal is put on.

C. S. G., of Ga.—You may freely make the matches described in No. 7, this volume, without phosphorus, while the foreign inventor has no patent. They are somewhat dangerous to make, like all other friction matches. We do not know where agate buttons are manufactured in this country. They are not made of the natural agate, but variegated glass.

W. P. B., of Del.—It requires about an equal amount of heat to evaporate a certain quantity of water, whether under low or high pressure.

C. D., of Conn.—Rough brass castings may be rendered bright by scouring them in a warm bath of dilute sulphuric or muriatic acid, then washing them in warm water.

J. Y., of Mo.—Ocean cables having parallel instead of spiral wires, and arranged as in your sketch, have been proposed several times.

W. C., of Del.—There is no reliable work published on the distillation of turpentine, as practiced at the present day.

F. P., of S. C.—The deep red color of bricks is produced by a small quantity of the red oxyd of iron in the clay. This may be imitated by art, by mixing about one ounce of the powdered peroxyd of iron with the clay in the pug-mill. The cement which is placed on brick-work to imitate stone is composed of clean sand, 90 parts, 5 parts of litharge and 5 parts of plaster of Paris, moistened with boiled linseed oil. The bricks receive two or three coats of oil before this cement is applied, and it requires considerable skill to lay it on. It soon becomes hard, and resembles brown freestone.

E. J., of N. J.—Attempts have been made to set tile-drains on one continuous operation of ditching and pipe-laying. A plow called a mole, having a sharp conical point was employed to cut the drain, and to it were attached the tiles strung upon a rope or chain drawn behind and laid down in the drain. This machine was defective in principle, because the tiles were dragged the whole length of the furrow. If you can invent a machine to set tile drains economically you will do well with it. Chains can be made of cast-steel as well as of cast-iron, and for some purposes they may be superior, because they could be made lighter and be equally as strong.

Money Received

At the Scientific American Office on account of Patent Office business, for the week ending Saturday, Sept. 10, 1859:—

J. B., of N. Y., \$30; C. & L., of N. C., \$25; J. K. D., of N. Y., \$30; G. K., of Pa., \$15; W. G., of N. Y., \$15; J. A., of La., \$25; W. P. C. of Ind., \$10; H. S., of Conn., \$35; R. T. C., of Ill., \$25; T. S. B., of N. Y., \$10; W. B., of Ohio, \$25; T. S. S., of Conn., \$57; J. B. B., of Kansas, \$30; L. G. K., of N. Y., \$25; M. P., of N. Y., \$25; R. E., of N. Y., \$30; P. & B., of Ill., \$32; D. W. G. H., of Maine, \$25; E. C., of Vt., \$60; J. M. C., of N. Y., \$75; G. H. P., of Ga., \$30; L. J. of Mich., \$30; J. B. F. P., of Me., \$32; G. B. S., of N. C., \$35; L. A. B., of N. Y., \$30; F. S., of Mich., \$25; J. McN., of N. Y., \$30; J. C., of Mass., \$30; A. C. K., of N. Y., \$25; C. M., of N. C., \$30; L. H. F., of Pa., \$30; W. B. Sr., of N. Y., \$30; A. M., of N. Y., \$30; A. P. A., of Ala., \$30; O. B. B., of Ill., \$30; J. W. C., of N. Y., \$300; W. N. R., of N. Y., \$30; O. C. McC., of Ohio, \$25; C. H., of L. I., \$30; B. H. C., of Wis., \$25.

Specifications, drawings and models belonging to parties with the following initials have been forwarded to the Patent Office during the week ending Saturday, Sept. 10, 1859:—

L. G. K. of N. Y.; L. L. of N. Y.; J. A. of La.; D. W. G. H. of Maine; J. G. of N. Y.; A. C. K. of N. Y.; J. C. A. of Ohio; J. B. F. P. of Mo.; H. S. of Conn.; O. C. McC. of Ohio; G. B. S. of N. C. (two cases); M. P. of N. Y.; J. B. of N. Y.; B. C. II. of Wis.; R. T. C. of Ill.; F. S. of Mich.; J. W. C. of N. Y.

Literary Notices.

We have received from the re-publishers, Messrs. Leonard Scott & Co., of this city, the July number of the "London Quarterly Review," and the August number of the "North British." Macaulay says:—"Her noble literature is the greatest of the many glories of England." And certainly at the head of this literature stand her quarterly reviews—the "London," the organ of the church and high Tories; the "Westminster," the organ of the radical democrats; the "Edinburgh," of the moderate whigs; and the "North British," of the Free Church of Scotland. We always welcome the "London Quarterly" for its masterly articles on science. The July number has an article on geology which furnishes, in the compass of half-an-hour's reading, just those general facts in regard to this sublime and interesting subject which every man wants to know.

S. B. MEYER'S CELEBRATED LEATHER VARNISH.—Any person sending me \$1 will receive my recipe for making the best leather varnish now in use. It makes the leather soft and durable, and puts the prettiest kind of gloss on it. Address S. B. MEYER, Lamar, Clinton county, Pa.

JONES & LENNIG, NOS. 313 AND 315 NEW Market-street, above Vine, Philadelphia, Pa., Manufacturers of Wet and Dry Patent Gas Meters; Station, Experimental, Show and Customer Meters; Meter Provers, Burner Provers, Mercury Cups, Governors, Center Seals, &c. Pressure Registers, Indicators and Gages, &c., &c. Messrs. Jones & Lennig beg leave to call the attention of Gas Companies, Gas Engineers, Gas-work Builders, and of consumers generally in the United States, Canada, South America, Cuba and California to the superior instruments they are now offering. Meters tested by a sworn inspector. Orders promptly attended to. 12 4"

MODEL AND PATTERN MAKING.—BY J. MURRAY, No. 220 Center-street, near Grand, New York. Patterns for brass, malleable and cast-iron. 12 5"

HOSIERY KNITTING-MACHINE FOR FAMILY and Plantation use; the most simple and complete Stocking-machine ever offered to the public. No family or plantation should be without one. Patent secured both in this and foreign countries, by the inventor and manufacturer, J. B. AIKEN, 84 Merchants' Exchange, Manchester, N. H. For an illustration and price of the machine, send for a pamphlet. 12 3mo

OWING TO A PRESSURE OF BUSINESS, THE subscriber offers for sale, for \$2,000, half cash, the entire right of his Self-acting Draft Regulator. Has been well treated and received two premiums. It produces a uniform draft, saves 25 per cent of the fuel in windy weather, prevents smoke blowing down the chimney and prevents the chimney taking fire. Address J. A. ROYCE, Lee, Mass. 1"

IMPORTANT TO INVENTORS.

AMERICAN AND FOREIGN PATENT SOLICITORS. Messrs. MUNN & CO., Proprietors of the SCIENTIFIC AMERICAN, continue to procure Patents for Inventors in the United States and all foreign countries on the most liberal terms. Our experience is of thirteen years' standing, and our facilities are unequalled by any other Agency in the world. The long experience we have had in preparing Specifications and Drawings has rendered us perfectly conversant with the mode of doing business at the United States Patent Office, and with most of the inventions which have been patented. Information concerning the patentability of inventions is freely given, without charge, on sending a model or drawing and description to this office.

Consultation may be had with the firm, between nine and four o'clock, daily, at their PRINCIPAL OFFICE, No. 37 PARK ROW, NEW YORK. We have also established a BRANCH OFFICE in the CITY OF WASHINGTON, on the CORNER OF F AND SEVENTH-STREETS, opposite the United States Patent Office. This office is under the general superintendence of one of the firm, and is in daily communication with the Principal Office in New York, and personal attention will be given at the Patent Office to all such cases as may require it. Inventors and others who may visit Washington, having business at the Patent Office, are cordially invited to call at our office.

We are very extensively engaged in the preparation and securing of Patents in the various European countries. For the transaction of this business we have Offices at Nos. 66 Chancery Lane, London; 29 Boulevard St. Martin, Paris, and 26 Rue des Eperonniers, Brussels. We think we may safely say that three-fourths of all the European Patents secured to American citizens are procured through our Agency.

Inventors will do well to bear in mind that the English law does not limit the issue of Patents to Inventors. Any one can take out a Patent there.

A pamphlet of information concerning the proper course to be pursued in obtaining Patents through our Agency, the requirements of the Patent Office, &c., may be had gratis upon application at the Principal Office or either of the Branches. We also furnish a Circular of Information about Foreign Patents.

The annexed letters from the last two commissioners of Patents we commend to the perusal of all persons interested in obtaining Patents:

Messrs. MUNN & CO.:—I take pleasure in stating that while I held the office of Commissioner of Patents, MORE THAN ONE-FOURTH OF ALL THE BUSINESS OF THE OFFICE came through your hands. I have no doubt that the public confidence thus indicated has been fully deserved, as I have always observed, in all your intercourse with the Office, a marked degree of promptness, skill, and fidelity to the interests of your employers.

Yours, very truly,

CHAS. MASON.

Immediately after the appointment of Mr. Holt to the office of Postmaster-General of the United States, he addressed to us the following very gratifying testimonial:

Messrs. MUNN & CO.:—It affords me much pleasure to bear testimony to the able and efficient manner in which you discharged your duties as Solicitors of Patents while I had the honor of holding the office of Commissioner. Your business was very large, and you sustained (and, I doubt not, justly deserved) the reputation of energy, marked ability, and uncompromising fidelity in performing your professional engagements. Very respectfully,

Your obedient servant,

J. HOLT.

Communications and remittances should be addressed to

MUNN & COMPANY,

No. 37 Park-row, New York.

FOR SALE—THREE VALUABLE PATENTS; one for upsetting tire, one for turning the band portion of carriage hubs to size of band, and one for cutting out carriage hubs to the taper of box. Address Z. DOOLITTLE, Perry, Georgia. 1*

WANTED—\$150 TO PATENT AN OMNIBUS register, in return for an equal interest in same. It will be of great or great value, as it overcomes every difficulty heretofore in the way. Address Register, Norwalk, Conn. 1*

GET THE BEST—WEBSTER'S UNABRIDGED DICTIONARY.—New pictorial edition. 1,500 pictorial illustrations. 9,000 to 10,000 new words in the vocabulary. Table of Synonyms, by Professor Goodrich, with other new features. Together with all the matter of previous editions. In one volume of 1,750 pages. Price \$6.50. Sold by all booksellers. 13*

G. & C. MERRIAM, Springfield, Mass.

CONJURING.—THE WHOLE ART OF CON- juring made easy, with full instructions for performing. 150 wonderful feats of magic, tricks, sleight-of-hand, ventriloquism and leggendama. Profusely illustrated. Price 15 cents. Sent postpaid by mail. Address M. M. SANBORN, Brasher Falls, N. Y. 13 2*

ONE OF WOODRUFF & BEACH'S SUPERIOR twelve-horse-power steam-engines for sale or exchange.—The above engine is in the best order, with locomotive boiler, and all accessories for both boiler and engine. I will sell it at a rare bargain for the purchaser, or exchange it on favorable terms for a second hand portable engine of from five to eight horse power. 1*

W. H. BARBER, Wolcottville, Conn.

WANTED.—AN AMERICAN ENGINEER wants a situation to take charge of or run any size engine, who has been for the last six years at one place. Best of reference given as to character and ability. Address W. A. R., No. 175 East Thirty-fourth-street. 1*

MACHINERY.—S. C. HILLS, NO. 12 PLATT- street, New York, dealer in Steam-engines, Boilers, Planers, Lathes, Chucks, Drills, Pumps, Mortising, Tenoning and Sash Machines, Woodworth's and Daniel's Planers, Dick's Punches, Presses and Shears; Cob and Corn Mills; Harrison's Grist Mills; Johnson's Shingle Mills; Belting, Oil, &c. 2 8w

W. M. WHITTEMORE (SUCCESSOR TO John Whittemore & Co.) 91 Maiden-lane, New York, Commission Merchant and dealer in Cotton and Woolen Machinery and manufacturers' supplies. 11 13

PARTNER WANTED—WITH \$5,000 OR UP- wards, to take an interest in three good inventions, to manufacture and introduce them in this and other countries. Also, a process for making extra meal. The germ is separated from the corn before it is ground. For particulars, send a stamp. 11 6*

O. P. STEVENS, Cleveland, Ohio.

15 HORSE HORIZONTAL STEAM-ENGINE, 10-inch bore, 24-inch stroke, with 7-foot fly-wheel, governor, pumps, &c., complete. A first-class engine at a bargain. 11 3

CHARLES H. SMITH, 135 North Third-street, Philadelphia.

KNITTING MACHINES, CIRCULAR AND straight, and machine-knitting needles, of all sizes and gauges, on hand and made to order. Address WALTER AIKEN, Franklin, N. H. 7 23*

FOR SALE—A 10-INCH WATER-WHEEL Shaft, 14 feet 9 inches long, with Flanges and Pillar Blocks, all in good order; will be sold very low. Apply to R. T. CORNELL, Hart's Village, Dutchess county, N. Y. 10 4*

IMPROVED SPRING BALANCES, CAPABLE of sustaining from 8 ounces to 1,000 pounds each, suitable for Post-office Scales, Butchers, Grocers, Fruit and Flour Dealers; also much used by Leather Inspectors. Flat and Tubular Locomotive Balances; also, French and Spanish Weight Balances, made to order and for sale by the manufacturer, THOS. MORTON (late Morton & Bremner), 212 Pearl-street, New York. 10 4*

THE AUBIN VILLAGE GAS WORKS WERE erected last year by gas companies in several States and in Canada. The success attending these works has already led to the erection of one city and one village work this season, has secured three village works for immediate erection, and so nearly secured five more that they may be relied on before August next. For reference apply to the Aubin Company, No. 44 State-street, Albany, N. Y. 1 13

CALIFORNIA AGENCY FOR PATENTS.— WETHERED & TIFFANY, San Francisco, will attend to the sale of patent rights for the Pacific coast. References:—Messrs. Tiffany & Co., New York; Wethered, Baltimore; George W. Bond & Co., Boston. 4 13

PECK'S PATENT DROP PRESS.—THE MOST perfect machine in use for the manufacture of silver, copper or tin-ware, spoons, jewelry, &c. Manufactured by the patentee. 4 22*

MILLO PECK & CO., New Haven, Conn.

APPEALS BEFORE THE JUDGES OF THE U. S. District Court, from the final decisions of the Patent Office, in Rejected Cases, Interferences, &c., are prosecuted by the undersigned on moderate terms. MUNN & CO., Solicitors of Patents, No. 37 Park-row (Scientific American Office), New York.

IRON PLANERS, ENGINE LATHES, AND OTHER Machinists Tools, of superior quality, on hand and finishing, and for sale low; also Harrison's Grain Mills. For descriptive circular, address New Haven Manufacturing Co., New Haven, Conn. 2 13

NEW YORK MACHINERY DEPOT.—MILBANK & ANNAN (successors to A. L. Ackerman), manufacturers and dealers in Woodworth Planers, Wick's Patent Re-sawing Machines; Sash, Door and Blind Machinery, Steam-engines and Boilers, Machinists' Tools, Files, Leather and Rubber-belting, and findings of every description, No. 232 Pearl-street, New York. 9 24*

SCIENTIFIC BOOKS AND PERIODICALS. English, French and American Scientific Books and Periodicals supplied promptly to order by JOHN WILEY, 56 Walker-street, New York. Catalogues gratis. Foreign orders forwarded as often as once a week. 9 4*

PATENT EXTENSIONS.—ALL PATENTS FOR Inventions, granted by the United States during the year 1845, will expire by their own limitations during the current year (1856) UNLESS EXTENDED ACCORDING TO LAW. The statute provides for the extension of Patents for an additional term of SEVEN YEARS, the grant being made to the inventor himself, or if deceased, to his heirs and administrators. The EXTENDED TERM inures solely to the benefit of the inventor or his heirs. Assignees or owners of rights under the first term of the Patent have no rights whatever in the extended term. The inventor or his heirs may, however, sell their interests in the Extension prior to the grant thereof, in which case the Extended Patent, when granted, becomes the exclusive property of such purchaser. Applications for Extensions must be made at the Patent Office at least 65 days prior to the extension of the Patent. The undersigned, having had great experience in Patent business, will promptly prepare the various documents and prosecute Extension cases on moderate terms. For further information address MUNN & CO., Solicitors of Patents, No. 37 Park-row (Scientific American Office), New York.

THE MOST VALUABLE BOOK OF THE AGE.— "The Graefenberg Manual of Health" has been revised and improved, and elegantly illustrated with beautifully colored engravings of the human system. Sent by mail to any part of the country on receipt of 25 cents. It is a complete guide to all diseases and their cures. It is written in plain style, and without scientific medical phrases, so that it can be comprehended by any one. The New York "Tribune" says:—"The Graefenberg Manual of Health" is an able and comprehensive family book." Address orders to JOSHUA F. BRIDGE, M. D., Secretary and Consulting Physician Graefenberg Company, No. 33 Park-row, New York. Dr. B. is constantly in the office of the Graefenberg Company, where he will receive letters from or hold personal consultation with invalids. 11 4

LEATHER AND RUBBER-BELTING, ENGINE and Hydraulic Packing, He ter Pipe-rings, Printers' Blankets, Roller Leather and Roller Cloths, Machine Cards, superior Lacing-leather, and all articles usually required for Manufacturers' use, for sale by MOSES H. EMERY, 112 Arch-street, Philadelphia. 10 4*

SAFE AND PROFITABLE BUSINESS.— DANIELS' Patent Granular Fuel is the growth of Swamps and waste-trimmings, limbs of trees, &c., cut into four-inch lengths. It is guaranteed to be preferred to charcoal or split pine wood for kindling fires; it can be manufactured for three cents a bushel. All engaged in its manufacture say its sale exceeds their most sanguine expectations, at 10 and 12 1/2 cents per bushel; 1,000 bushels per day can be cut with Daniels' Patent Fuel-cutter and two-horse power. The sale in Worcester, Mass., is 100,000 bushels a year. For circulars, containing references, &c., &c., address 12 1*

B. D. WASHBURN, Taunton, Mass.

WANTED—VOL. I., SCIENTIFIC AMERICAN, to complete a set; \$10 will be paid, if complete and bound in good order, or if in numbers, 15 cents each will be paid. Please address JOHN T. NESSLE, Albany, N. Y. 12 1*

IMPORTANT TO MANUFACTURING JEWEL- lers and others.—Lava, for the manufacture of Brooches, &c. Just received, a fresh importation of the genuine raw material, 23 shades of carbon. This Lava is positively indestructible. 10 4*

BOTTOMLEY & HINES, West Philadelphia, Pa.

JOHN W. QUINCY & CO., IMPORTERS AND Dealers in Metals, &c., No. 98 William-street, New York. Banca Tin, Spelter, Ingot Copper, Lead, Antimony, Babbitt Metal, Mount Hope Cut Nails, Ames' Shovels and Spades, &c. 12 25w*

EIGHT-HORSE PORTABLE STEAM ENGINE cylinder 7 1/2 by 15, governor, balance-wheel, &c., attached to a fine boiler, all new. Price \$600. S. C. HILLS, 3 83w No. 12 Platt-street, New York.

GRINDSTONES FOR MACHINISTS AND MAN- ufacturers, of every size and grit, for wet or dry grinding. 9 30m* J. E. MITCHELL, No. 310 York-avenue, Philadelphia.

ALCOTT'S CONCENTRIC LATHES — FOR Broom, Hoe and Rake Handles, Chair Rounds, &c.—price \$25 —and all other kinds of wood-working machinery, for sale by 1 1mtf S. C. HILLS, No. 12 Platt-street, New York.

A MESSIEURS LES INVENTEURS—AVIS IM- portant.—Les inventeurs non familiers avec la langue Anglaise, et qui preferent nous communiquer leurs inventions en Francais, peuvent nous adresser dans leur langue natale. Envoyez nous un dessin et une description concise pour notre examen. Toutes communications seront recues avec confiance. MUNN & CO., Scientific American Office, No. 37 Park-row, New York.

OIL! OIL! OIL!—FOR RAILROADS, STEAM- ers, and for Machinery and Burning. Pease's Improved Machinery and Burning Oil will save fifty per cent., and will not gum. This Oil possesses qualities vitally essential for lubricating and burning, and found in no other oil. It is offered to the public upon the most reliable, thorough and practical test. Our most skillful engineers and machinists pronounce it superior to and cheaper than any other, and the only oil that is in all cases reliable and will not gum. The SCIENTIFIC AMERICAN, after several tests, pronounces it "superior to any other they have ever used for machinery." For sale only by the Inventor and Manufacturer, F. S. PEASE, No. 61 Main-street, Buffalo, N. Y. 1 13

N. B.—Reliable orders filled for any part of the United States and Europe.

STEAM ENGINES, STEAM BOILERS, STEAM Pumps, Saw and Grist Mills, Marble Mills, Rice Mills, Quartz Mills for gold quartz, Sugar Mills, Water Wheels, Shafting and Pulleys. The largest assortment of the above in the country kept constantly on hand by WM. BURDON, No. 102 Front-street, Brooklyn, N. Y. 1 13

MACHINE BELTING, STEAM PACKING, EN- GINE HOSE.—The superiority of these articles, manufactured of vulcanized rubber, is established. Every belt will be warranted superior to 1 ther, at one-third less price. The Steam Packing is made in every variety, and warranted to stand 300 degs. of heat. The Hose never needs oiling, and is warranted to stand any required pressure; together with all varieties of rubber adapted to mechanical purposes. Directions, prices, &c., can be obtained by mail or otherwise at our warehouse. NEW YORK BELTING AND PACKING COMPANY. JOHN H. CHEEVER, Treasurer, 1 13 Nos. 37 and 38 Park-row, New York.

TABLES SHOWING THE HORSE-POWER OB- tained from a Belt of a given width and velocity. Price, post-paid, \$1. Address A. H. SAUNDERS, Nashua, N. H. 9 4*

PORTABLE COAL GAS APPARATUS.—IT IS A Fixed Fact!—The Gas Generating Co. is a great success, and their apparatus works beyond their most sanguine expectations. It is to be seen in operation at the St. Denis Hotel, 401 Broadway, German Clubhouse, 106 Fourth-avenue, and at the office of the Company No. 512 Broadway, opposite the St. Nicholas Hotel. Judge for yourselves, and recollect. HENDRICKX BROTHERS, Patentees. 1 13

WOODWORTH PLANERS—IRON FRAMES TO plans 18 to 24 inches wide, at \$90 to \$110. For sale by S. C. HILLS, No. 12 Platt-street, New York. 1 13

HOYT BROTHERS, MANUFACTURERS OF Patent-Stretched, Patent-Invented, Patent-Jointed, Oak-Leather BELTING. Store, Nos. 28 and 30 Spruce-street; Manufactory, Nos. 210, 212, 214 and 316 Eldridge-street, New York. A "Treatise on Machinery Belting" is furnished on application, by mail or otherwise, gratis. 1 12*

CARY'S CELEBRATED DIRECT-ACTING SELF- Adjusting Rotary Force Pump, unequalled in the world for the purpose of raising and forcing water, or any other fluid. Manufactured and sold by CARY & BRAINARD, Brockport, N. Y. Also for sale by J. C. CARY, No. 240 Broadway, New York. 8 18

FELT FOR STEAM BOILERS, PIPES, SHIP Sheathing, Marble Polishers, Jewelers and Calico Printers' use, manufactured by JOHN H. BACON, Winchester, Mass. 1 15*

BOILER FLUES FROM 1 1/4 INCH TO 7 INCH- es outside diameter, cut to any length desired, promptly furnished by JAMES O. MORSE & CO., No. 76 John-street, New York. 7 1*

GUILD & GARRISON'S STEAM PUMPS FOR all kinds of independent Steam Pumping, for sale at 55 and 57 First-street, Williamsburgh, L. I., and 74 Beekman-street, New York. 1 13 GUILD, GARRISON & CO.

LUCIUS W. POND, MANUFACTURER OF SU- perior Planing-machines for Iron, Engine Lathes and Machinists Tools generally. Address L. W. POND, Worcester, Mass. 2 16*

WROUGHT IRON PIPE, FROM ONE-EIGHTH of an inch to six inches bore; Galvanized Iron Pipe, (a substitute for lead), Steam Whistles, Stop Valves and Cocks, and a great variety of Fittings and Fixtures for Steam, Gas, and Water, sold at wholesale and retail. Store and Manufactory, No. 76 John-street, and Nos. 29, 31 and 33 Platt-street, New York. 7 1*

JAMES O. MORSE & CO.

CROSSETT'S PATENT STAVE CUTTER—PAT- ented July 1, 1844; re-issued March 2, 1853; renewed and extended June 26, 1855.—The above mentioned machine is warranted to cut more and better staves than any other machine in the United States, and is the most simple, cheap and durable. I hereby caution all persons against using and vending said machine (the main features of which consist in the stationary knife and vibratory bed-piece) without the legal right to do so. Offenders will be dealt with according to law. All persons wishing an interest in the extended term of said patent can obtain it by addressing the undersigned at Joliet, Ill. 5 10 GEO. I. CROSSETT, Assignee.

CHRONOMETERS, FINE WATCHES, NAUTI- CAL AND ASTRONOMICAL INSTRUMENTS, &c.—D. EGGERT & SON, No. 239 Pearl-street, New York, offer on favorable terms first-class Marine, Siderial and Pocket Chronometers; also plain and finer quality of Watches, with new series train, so thoroughly adjusted as to be unaffected by any change of temperature, exercise or position in the pocket; Astronomical Clocks, Transit Instruments, Standard and Self-Registering Thermometers, Barometers, &c. 1 180w*

CHARLES W. COPELAND, CONSULTING AND Superintending Engineer, No. 122 Broadway, New York. Plans and Specifications prepared for all kinds of Steam-engines and Machinery. Steam Vessels and Steam-engines, both new and second-hand, for sale. Also, Wire-ropes, Steam and Water-gages, Indicators, Steam Fire-engines, Pumps, &c., &c. 10 13

CAST-STEEL WIRE—IN THE ROUND; ALSO, Flattened and Tempered, for Crinoline purposes. For sale by the importer, THOMAS MORTON, 212 Pearl-street, New York. 10 4*

SLIDE LATHES, IRON PLANING-MACHINES, Bolt-cutting Machines, Drills, &c.—A large stock on hand, at reduced prices. Address CHARLES H. SMITH, 135 North Third-street, Philadelphia. 11 6

Zur Beachtung für Erfinder. Erfinder, welche nicht mit der englischen Sprache befannt sind, können ihre Mittheilungen in der deutschen Sprache machen. Skizzen von Erfindungen mit kurzen, deutlich geschriebenen Beschreibungen beliebe man zu adressiren an Munn & Co., 37 Park Row, New-York. Auf der Office wird deutsch gesprochen.

IMPROVED LIFE-SAVING RAFT.

In this age, when so many people are traveling, anything which diminishes the dangers of the sea is of great value; and even where no accident occurs, a knowledge, on the part of the passengers, that every provision has been made for their safety, is a relief to their minds, and thus contributes, in no small measure, to their comfort. The accompanying engravings represent a raft for saving shipwrecked persons at sea, for which Letters Patent were granted to A. G. Mack, of Rochester, N. Y., July 12, 1859.

Fig. 1 is a perspective view, showing the position of the raft when in use; Fig. 2 is a top view of the raft as seen when floating on the water; and Fig. 3 is a vertical section. The large central cylinder, A, is made water-tight, with a man-hole in the top, which is covered by a tight trap-door; to this central cylinder the hollow, water-tight, truncated cones, B B, are attached by means of hinged joints, forming, with the cylinder, the floating power. A rope, a, passes around the extreme ends of the floats, B, being looped to eyes fixed to the ends of the floats. A rope, b, is then passed through eyes fixed upon the surface of each float, and through holes in a flange on the top of the cask, A, forming an endless running rope, so arranged as to allow the floats to fold down against the cylinder, when this is suspended by the ring in its top. A rope, c, is then passed through eyes fixed mid-way between the ends of the floats, B, which is carried entirely around the raft, and concentric with ropes, d and e, which are arranged in the same manner. These ropes hold the canvas, E, down upon the floats, and keep it in place, both when the raft is in the water and when it is folded up; the floats are further secured together by ropes under the canvas, running diagonally from one float to another.

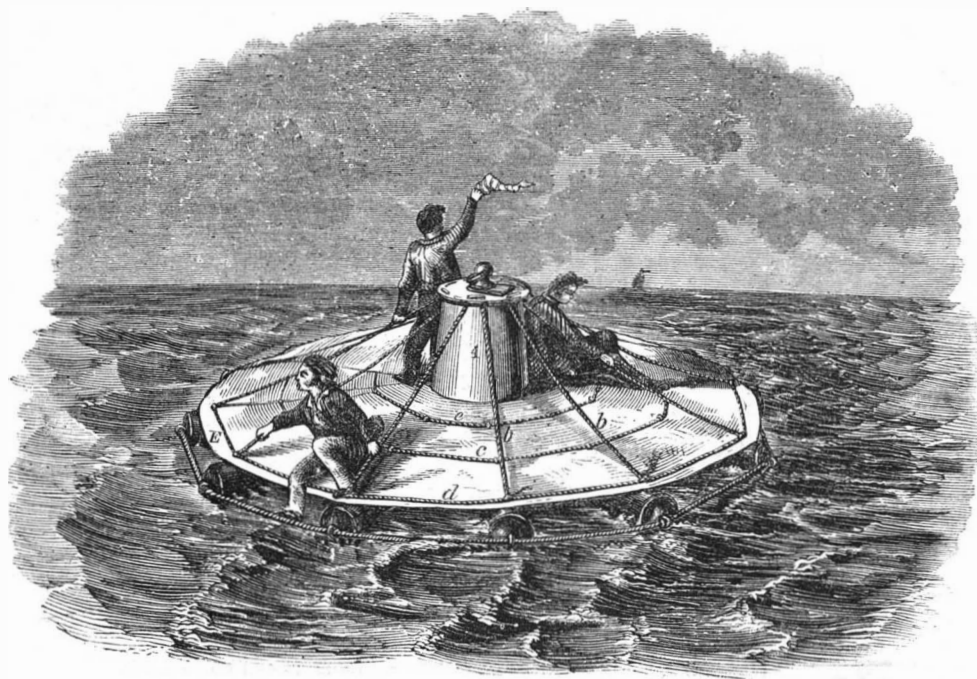

MACK'S LIFE-SAVING RAFT.

stance, previous instances being confined to a few furnaces in South Wales (where hematite ore is used as a mixture), and to some in the Hartz mountains, in both of which cases the specimens found were comparatively small. Small crystals of it have long been found in the slags of many iron works. Should any commercial use be discovered for titanium, it may be supplied in considerable quantities.

NEW FALLING RACK FOR MANGERS.

"The wonder is that it has not been thought of before" is the usual expression, as some simple but novel idea is brought out by some one of our host of inventors.



Here is a plan for preventing horses from wasting their hay, invented by a practical livery stable-keeper, which is certainly worthy of the attention of our city railroad companies and omnibus proprietors.

The rod, a, connects the rack, B, with the feed-box, A, forming a hinged joint. The slats, b and c, of the rack are just far enough apart to allow the horse to pull out but a mouthful of hay at a time, thus preventing him from wasting it. As the hay descends in the box, the rack follows it down, turning on the rod, a, and protecting the hay till all is consumed. The bottom of the box is made tight to save the grain, and the edge of the box, as well as the bars of the rack, may be covered with metal to prevent them from being gnawed.

At the end of the manger or hay-box is the grain-box, C, fitted with a tight lid or cover, D. Both box and lid should be lined with metal to make them rat-proof. The grain-box is filled whenever the hostler has leisure, and is covered with the lid. If the horses come in too much heated to eat grain, the lid is allowed to remain closed until the horses are cooled, when, by simply throwing up the lid, the horses are fed, and a large number can thus be served by one attendant.

Further information may be had by addressing the inventor, John Packer, at his office, No. 222 South Fourth-street, Philadelphia. The patent on this invention was granted March 29, 1859.

WALKING THE WATER.—

A gentleman residing on one of the inland lakes of Wisconsin has been making a series of experiments with water-shoes for the purpose of walking upon the water as upon land. He has written a letter to one of the Chicago papers describing his experiments, which have all been made at night, when the lake was calm. It is stated that, with the aid of a miniature pair of sails attached to his arms, and which can be reefed or spread in a moment, the inventor of this novel contrivance has crossed a lake three miles wide in half an hour, without so

much as wetting his knees in the passage. He proposes to cross Lake Michigan on foot and give a public exhibition of his ability to do so.

ENCOURAGING SUCCESS.—A. Hammond, writing to us from Jacksonville, Ill., under date of August 27th, says: "My patent for mole-plow and ditcher came to hand on the 22d inst. You will please receive my thanks for the promptness with which you attended to my business. I have already received orders for \$2,500 worth of machines, and considerable territory; and you may rest assured that I shall confide all my future patent business to your hands, and shall advise all my acquaintances to do the same."

MECHANICS, INVENTORS, MILLWRIGHTS, AND MANUFACTURERS.

The SCIENTIFIC AMERICAN is a paper peculiarly adapted to all persons engaged in these pursuits, while to the Farmer, Housekeeper, and Man-of-Science, it will be found of equal interest and use.

The SCIENTIFIC AMERICAN has been published **FOURTEEN YEARS**, and has the largest circulation of any journal of its class in the world. It is indispensable to the Inventor and Patentee; each number containing a complete official list of the claims of all the patents issued each week at the United States Patent Office, besides elaborate notices of the most important inventions, many of which are accompanied with engravings executed in the highest degree of perfection.

To the Mechanic and Manufacturer the SCIENTIFIC AMERICAN is important, as every number treats of matters pertaining to their business, and as often as may be deemed necessary a column or two on the metal and lumber markets will be given; thus comprising, in a useful, practical, scientific paper, a Price Current which can be relied upon.

The SCIENTIFIC AMERICAN is published weekly, in a form suitable for binding, each number containing sixteen pages of letter-press, with numerous illustrations, making a yearly volume of 882 pages of useful matter not contained in any other paper.

Terms.

Two volumes will be issued each year; but there will be no CHANGE IN THE TERMS OF SUBSCRIPTION, as the two yearly volumes together will be Two Dollars a Year, or One Dollar for Six Months.

Club Rates.

- Five Copies, for Six Months.....\$4
- Ten Copies, for Six Months.....\$8
- Ten Copies, for Twelve Months.....\$15
- Fifteen Copies, for Twelve Months.....\$22
- Twenty Copies, for Twelve Months.....\$28

For all clubs of Twenty and over, the yearly subscription is only \$1 40. Names can be sent in at different times and from different Post-offices. Specimen copies will be sent gratis to any part of the country.

When persons order the SCIENTIFIC AMERICAN they should be careful to give the name of the Post-office, County, and State to which they wish the paper sent. And when they change their residence, and wish their paper changed accordingly, they should state the name of the Post-office where they have been receiving it and that where they wish it sent in future.

MUNN & CO.
Publishers, No. 37 Park-row, New York.

Fig. 2

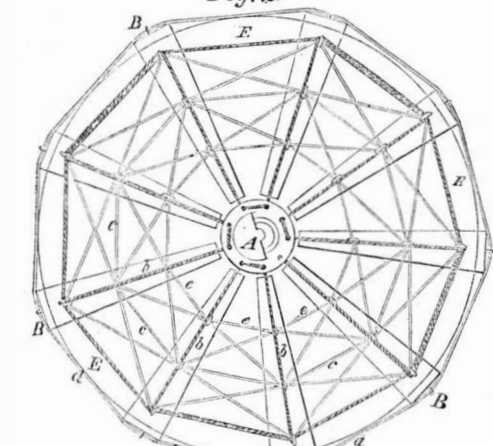
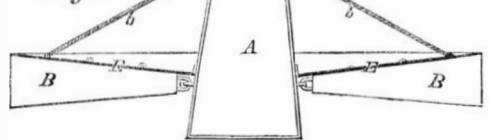

Fig. 3



In case of need, the raft is lowered over the side of the vessel, when it spreads out on the water and is ready for use, and the central cylinder may be stored with water and provisions. For further particulars, address Harrington & Mack, Rochester, N. Y.

LARGE SPECIMENS OF TITANIUM.

At the Manchester (England) Literary and Philosophical Society, Mr. Wm. Brockbank, lately exhibited some large specimens of titanium, which have recently been found in considerable quantities, filling the crevices and under the hearths of the fire-brick linings of the